

GRM31M7U1H823JA01#

indicates a package specification code.



< List of part numbers with package codes >
 GRM31M7U1H823JA01L , GRM31M7U1H823JA01K

Shape

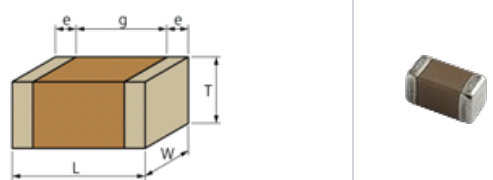

L size	3.2 ±0.15mm
W size	1.6 ±0.15mm
T size	1.15 ±0.1 mm
External terminal width e	0.3 to 0.8mm
Distance between external terminals g	1.5mm min.
Size code in inch(mm)	1206 (3216M)

References

Packaging	Specifications	Minimum quantity
L	φ 180mm Embossed taping	3000
K	φ 330mm Embossed taping	10000

Mass (typ.)	
1 piece	27.0mg
φ 180mm Reel	125g

Specifications

Capacitance	82000pF ±5%
Rated voltage	50Vdc
Temperature characteristics (complied standard)	U2J(EIA)
Temperature coefficient	-750±120ppm/°C
Temperature range of temperature characteristics	25 to 85°C
Operating temperature range	-55 to 125°C

Attention

- 1.This datasheet is downloaded from the website of Murata Manufacturing Co., Ltd. Therefore, it's specifications are subject to change or our products in it may be discontinued without advance notice. Please check with our sales representatives or product engineers before ordering.
- 2.This datasheet has only typical specifications because there is no space for detailed specifications. Therefore, please review our product specifications or consult the approval sheet for product specifications before ordering.

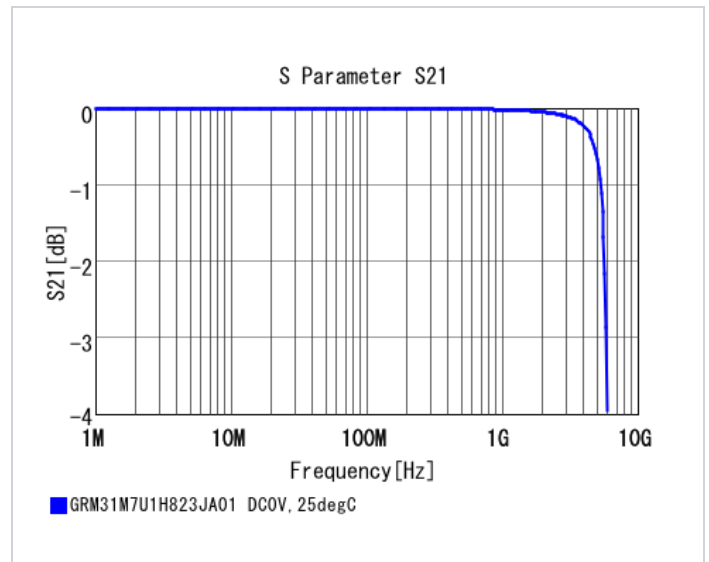
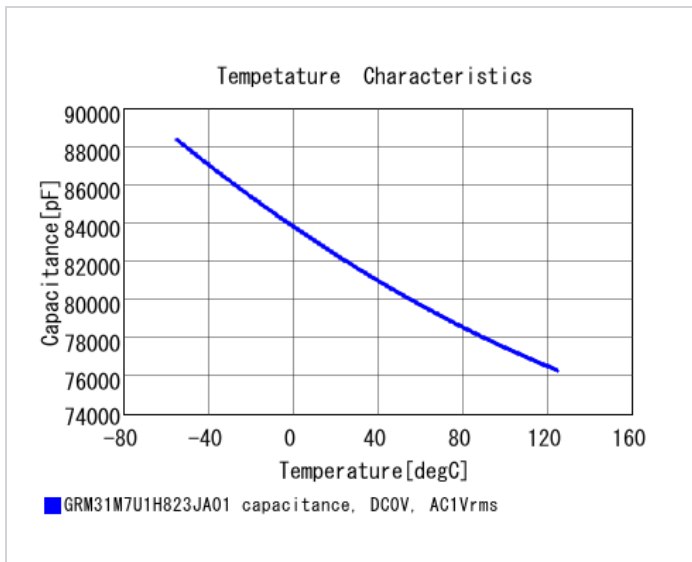
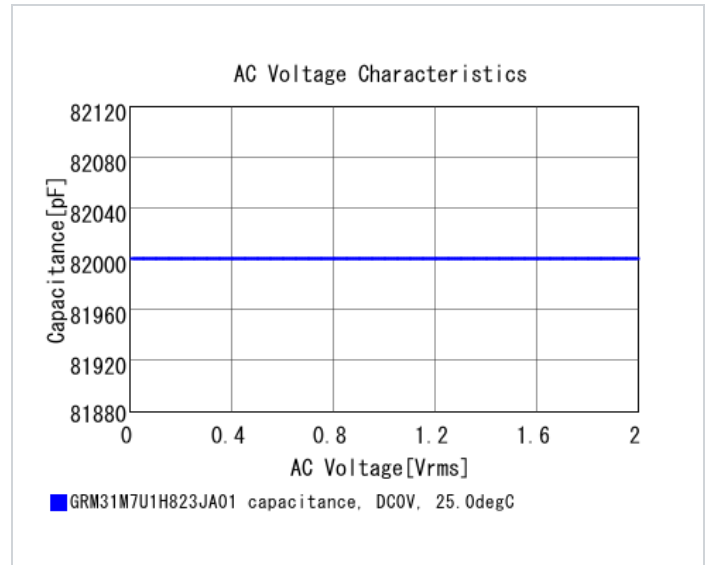
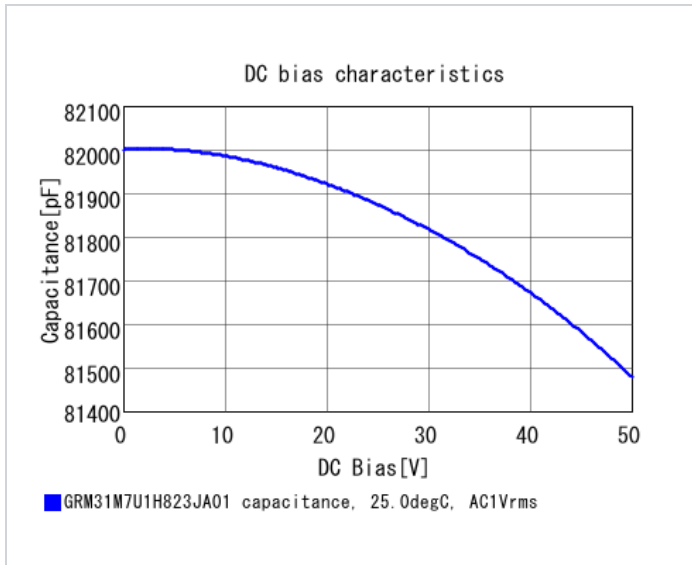
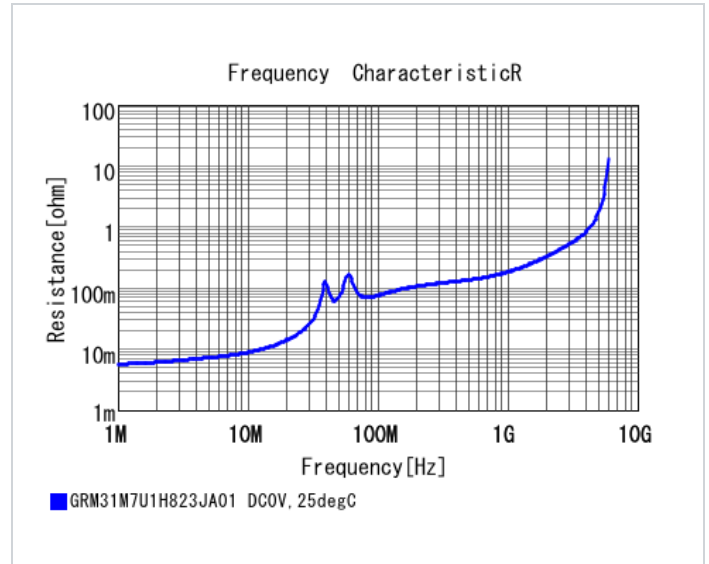
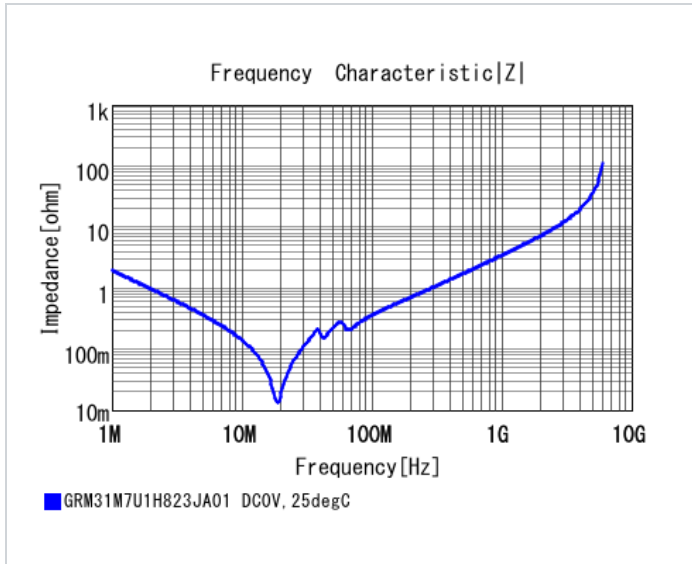

Attention

- 1.This datasheet is downloaded from the website of Murata Manufacturing Co., Ltd. Therefore, it's specifications are subject to change or our products in it may be discontinued without advance notice. Please check with our sales representatives or product engineers before ordering.
- 2.This datasheet has only typical specifications because there is no space for detailed specifications. Therefore, please review our product specifications or consult the approval sheet for product specifications before ordering.