

# AAT3607: PMU with OVP Dynamic Li-ion Charger

## Applications

- Cellular phones
- Digital cameras
- Handheld instruments
- MP3 and MP4
- PDAs and handheld computers
- Portable GPS devices

## Features

- VIN operating range: 4.1 V to 5.5 V
- Over-voltage input protection
- Functional without battery connected
- Dynamic Li-ion charger:
  - Charge enable control
  - Two programmable/selectable charging currents up to 1 A
  - Programmable end of charge current
  - Charge current reduction
  - Thermal loop charge reduction
  - Reverse blocking
- Three 1.6 MHz synchronous programmable step-down converters:
  - 120 switching phase shift
  - Three independent enable controls
  - Buck 1: 400 mA
  - Buck 2: 300 mA
  - Buck 3: 300 mA
- Two programmable and separate enable LDOs:
  - LD01: 150 mA
  - LD02: 150 mA
- Fault protection scheme:
  - Under-voltage lockout (UVLO)
  - Over-temperature protection (OTP)
- Fast turn-on time
- Built-in soft-start and power on reset
- Low standby current
- Thermally enhanced TQFN (28-pin, 4 mm × 4 mm) package (MSL1, 260 °C per JEDEC J-STD-020)

## Description

The AAT3607 is a member of the Skyworks Total Power Management IC (TPMIC™) product family that functions as a highly integrated power management unit (PMU) for MP3/MP4 players and other handheld applications. It integrates a single-cell Lithium Ion/Polymer battery dynamic charger module powered from an AC/DC adapter or USB port, three 120° phase shifted synchronous 1.6 MHz DC-DC step-down converters and two LDOs for the system.

The typical input power source for the AAT3607 is a single-cell Li-ion battery. The charger can be powered from either a current-limited USB port or an AC/DC adapter, with charge current programmed by two separate external resistors and selected by a logic input pin. With the device's dynamic charging feature, a system connected to the AAT3607 can draw power from the power supply without a battery, or charge the battery with the power left over from the system. If the power supply has limited current capability, the system draws power from both the limited power supply source and the battery.

The battery charger is a complete constant current/constant voltage linear charger. It offers an integrated pass device, reverse blocking protection, high accuracy current and voltage regulation, charge status, and charge termination. The charging current is programmable by means of an external resistor up to 1 A.

The AAT3607 also includes over-voltage input protection (OVP), under-voltage lockout (UVLO), and over-temperature protection (OTP) to protect the PMU under fault conditions.

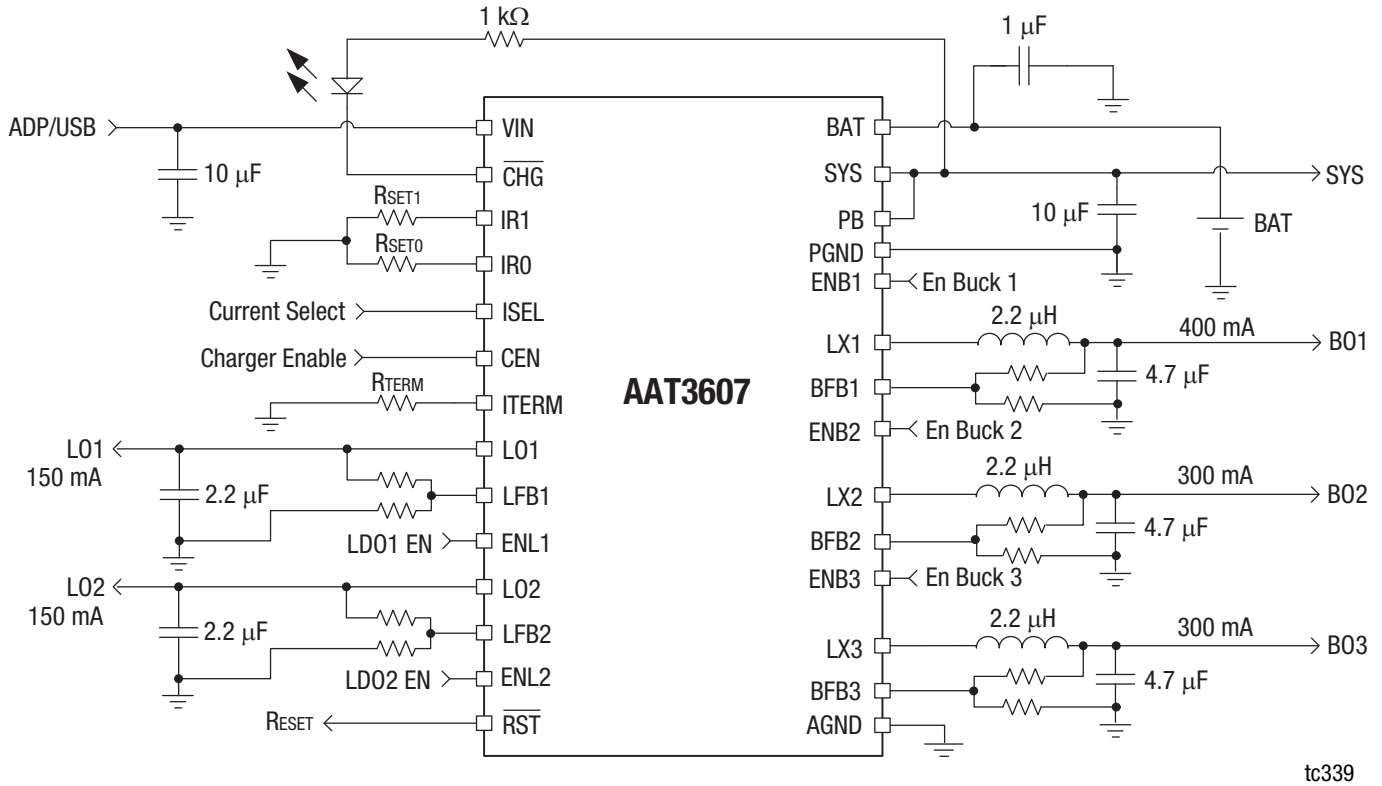
The three integrated step-down converters operate under synchronous PWM control with a 1.6 MHz switching frequency and internal compensation, decreasing both size and quantity of external components. The phase shift feature allows ripple cancellation between the three converters when all are running with nominal load.

The AAT3607 is available in a thermally enhanced 28-pin 4 mm × 4 mm TQFN package with exposed pad.

A typical application circuit is shown in Figure 1. The pin configurations are shown in Figure 2. Signal pin assignments descriptions are provided in Table 1.

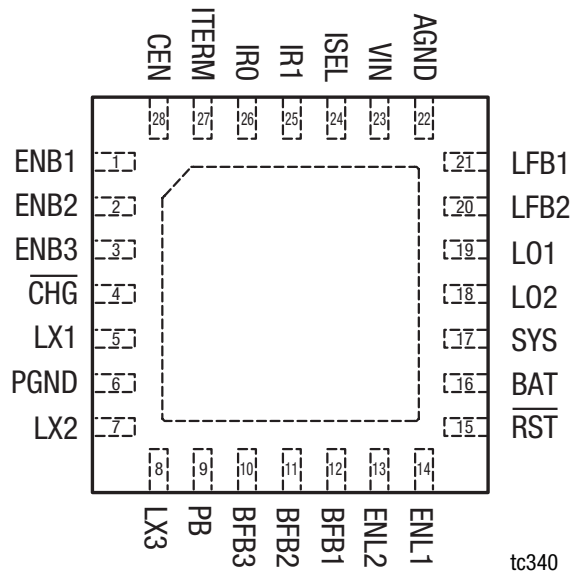


Skyworks Green™ products are compliant with all applicable legislation and are halogen-free. For additional information, refer to *Skyworks Definition of Green™*, document number SQ04-0074.



tc339

Figure 1. AAT3607 Typical Application Circuit



tc340

Figure 2. AAT3607 Pinout - 28-Pin, 4 mm x 4 mm TQFN (Top View)

**Table 1. AAT3607 Signal Descriptions**

Pin Number	Name	Description
1	ENB1	Enable input for Buck 1 with 1 M $\Omega$ internal pull down resistor.
2	ENB2	Enable input for Buck 2 with 1 M $\Omega$ internal pull down resistor.
3	ENB3	Enable input for Buck 3 with 1 M $\Omega$ internal pull down resistor.
4	$\overline{\text{CHG}}$	Open drain charge status output. Active low to indicate the battery is charging.
5	LX1	Inductor switching node of Buck 1.
6	PGND	Power ground.
7	LX2	Inductor switching node of Buck 2.
8	LX3	Inductor switching node of Buck 3.
9	PB	Input power for Buck 1, 2, and 3. Connect to SYS with a bypass capacitor to ground.
10	BFB3	Feedback pin for Buck 3; connect to a resistor divider for an adjustable output voltage.
11	BFB2	Feedback pin for Buck 2; connect to a resistor divider for an adjustable output voltage.
12	BFB1	Feedback pin for Buck 1; connect to a resistor divider for an adjustable output voltage.
13	ENL2	Enable input for LDO 2 with 1 M $\Omega$ internal pull-down resistor.
14	ENL1	Enable input for LDO 1 with 1 M $\Omega$ internal pull-down resistor.
15	$\overline{\text{RST}}$	Open drain reset output. Active low to indicate that BFB1, or BFB2, or BFB3 is below its regulation threshold after enable. $\overline{\text{RST}}$ goes high 200 ms after the last enabled Buck reaches 80% of the regulation threshold. $\overline{\text{RST}}$ is high-impedance when ENB1, 2 and 3 are low, and VIN is unconnected.
16	BAT	Positive battery terminal connection. Connect BAT to the positive terminal of a single-cell Li+/Li-Poly battery. Bypass BAT to GND with a 1 $\mu$ F to 10 $\mu$ F ceramic capacitor.
17	SYS	System supply output. Bypass SYS to GND with a 10 $\mu$ F ceramic capacitor. If a valid voltage is present at VIN, and the system load exceeds the input supply current limit to cause VIN drops below BAT, then both the external power source and the battery supplies current to SYS. SYS is connected to BAT through an internal system load switch when a valid source is not present at VIN.
18	L02	LDO 2 output with 5 k $\Omega$ internal pull down resistor for fast turn off.
19	L01	LDO 1 output with 5 k $\Omega$ internal pull down resistor for fast turn off.
20	LFB2	Feedback pin for LDO 2; connect to a resistor divider for an adjustable output voltage.
21	LFB1	Feedback pin for LDO 1; connect to a resistor divider for an adjustable output voltage.
22	AGND	Analog ground.
23	VIN	DC power input from AC/DC adapters or USB input.
24	ISEL	Charge current setting selection input to select IRO or IR1.
25	IR1	Charge current 1 programming resistor, selected by ISEL = 1.
26	IRO	Charge current 2 programming resistor, selected by ISEL = 0.
27	ITERM	Connect a resistor between this pin and ground to set the end of charge termination current.
28	CEN	Battery charger enable pin, active high with 200 k $\Omega$ internal pull down resistor.
	EP	Exposed pad. Connect to ground directly beneath the package.

**Electrical and Mechanical Specifications**

The absolute maximum ratings of the AAT3607 are provided in

Table 2, the recommended operating conditions are listed in Table 3, and electrical specifications are provided in Table 4.

**Table 2. AAT3607 Absolute Maximum Ratings (Note 1)**

Parameter	Symbol	Minimum	Maximum	Units
Maximum DC input voltage for VIN	VIN_MAX		7.5	V
Maximum rating	Power and logic pins		VIN + 0.3	V
Operating temperature range	TJ	-40	85	°C
Soldering temperature range	Ts	-65	150	°C
Maximum soldering temperature (at leads, 10 sec.)	TLEAD		300	°C

**Note 1:** Exposure to maximum rating conditions for extended periods may reduce device reliability. There is no damage to device with only one parameter set at the limit and all other parameters set at or below their nominal value. Exceeding any of the limits listed may result in permanent damage to the device.

**Table 3. AAT3607 Recommended Operating Conditions**

Parameter	Symbol	Value	Units
Thermal resistance	θJA	49	°C/W
Thermal resistance from junction to case	θJC	29	°C/W
Maximum power dissipation	PD	2.0	W

---

**CAUTION:** Although this device is designed to be as robust as possible, electrostatic discharge (ESD) can damage this device. This device must be protected at all times from ESD. Static charges may easily produce potentials of several kilovolts on the human body or equipment, which can discharge without detection. Industry-standard ESD precautions should be used at all times.

---

**Table 4. AAT3607 Electrical Specifications (1 of 2) (Note 1)****(VIN = 5 V, VBAT = 3.6 V, VSYS = VIN or VBAT, TA = -40 °C to +85 °C, Typical Values are TA = 25 °C, Unless Otherwise Noted)**

Parameter	Symbol	Test Condition	Min	Typical	Max	Units
<b>Power Supply</b>						
Input over-voltage protection range	VIN_OVPMAX	AC/DC adaptor connected			7.5	V
DC input operating voltage	VIN		4.1		5.5	V
Battery input operating voltage	VBAT		2.7		4.2	V
Quiescent current	Iq	Buck 1-3 and LDO 1/2 enable, battery charger enabled, no load		700	1000	μA
Shutdown current	ISHDN	CEN; ENL1; ENL2; ENB1; ENB2; ENB3 = 0			1	μA
Under-voltage lockout voltage	VUVLO	VIN rising	3.85	4	4.1	V
UVLO hysteresis	VUVLOHYS			500		mV
Over-voltage protection voltage	VOVP	VIN rising	6.05	6.25	6.45	V
OVP hysteresis	OVPHYS			200		mV
OVP switch on-resistance	OVP RDSON			0.18		Ω
Load switch current limit	ILIM		900	1000	1100	mA
<b>Buck 1</b>						
Input voltage	VPB			VSYS		V
Output voltage accuracy	VACC_B01	IB01 = 10 mA to 400 mA, VIN = 4.1 V to 5.5 V	-3		3	%
Output voltage range	VRG_B01		0.6		VSYS - 0.6	V
Feedback voltage	VBFB1		0.591	0.6	0.609	V
Maximum load current	IB01_MAX		400			mA
Feedback leakage	IB01FBL	IB01FB = 0.6 V			0.2	μA
P-channel current limit	IB01LIMP			800		mA
High side switch on-resistance	RB01(DSON)_P			300		mΩ
Low side switch on-resistance	RB01(DSON)_N			200		mΩ
Load regulation	ΔVB01/VB01	ILOADB1 = 10 mA to 400 mA		1		%
Line regulation	ΔVLB01/ΔVB01	VIN = 4.1 V to 5.5 V, ILOADB1 = 400 mA		0.3		%/V
Oscillator frequency	foscB1			1.6		MHz
Start-up time	tsB1	From enable to output regulation		120		μs
Input low current	IENB1	VSYS = VFBB1 = 5.0 V	-10		10	μA
RST pin sink current	IRST			8		mA
RST pin low voltage	VRST_LOW	IRST = 4 mA			0.4	V
<b>Buck 2 and Buck 3</b>						
Input voltage	VPB			VSYS		
Output voltage accuracy	VACC_B02,3	IB02,3 = 10 mA to 300 mA	-3		3	%
Output voltage range	VRG_B02,3		0.6		VSYS - 0.6	V
Feedback voltage	VBFB2,3		0.591	0.6	0.609	V
Maximum load current	IB02,3_MAX		300			mA
Feedback leakage	IB02,3FBL	VB02,3FB = 0.6 V			0.2	μA
P-channel current limit	IB02,3LIM_P			600		mA
High-side switch on-resistance	RB02,3DSON_P			300		mΩ
Low-side switch on-resistance	RB02,3DSON_N			200		mΩ

**Table 4. AAT3607 Electrical Specifications (2 of 2) (Note 1)**  
**(VIN = 5 V, VBAT = 3.6 V, VSYS = VIN or VBAT, TA = -40 °C to +85 °C, Typical Values are TA = 25 °C, Unless Otherwise Noted)**

Parameter	Symbol	Test Condition	Min	Typical	Max	Units
<b>Buck 2 and Buck 3</b>						
Load regulation	$\Delta V_{B02,3}/V_{B02,3}$	I <sub>LOADB2,3</sub> = 10 mA to 300 mA		1		%
Line regulation	$\Delta V_{LB02,3}/\Delta V_{B02,3}$	V <sub>IN</sub> = 4.1 V to 5.5 V, I <sub>LOADB2,3</sub> = 300 mA, TA = 25 °C		0.3		%/V
Oscillator frequency	f <sub>OSCB2,3</sub>			1.6		MHz
Start-up time	t <sub>SB2,3</sub>	From enable to output regulation		120		μs
Input low current	I <sub>ENB2,3</sub>	V <sub>SYS</sub> = V <sub>FBB2,3</sub> = 5.0 V	-10		10	μA
<b>Battery Charger</b>						
Output charger voltage regulation	V <sub>BAT_REG</sub>	0 °C ≤ TA ≤ +70 °C	4.158	4.2	4.242	V
Preconditioning voltage threshold	V <sub>MIN</sub>		2.4	2.6	2.8	V
Preconditioning charge current	I <sub>CH_PRE</sub>			10		%I <sub>CH_CC</sub>
Constant-current mode charge current	I <sub>CH_CC</sub>	I <sub>SEL</sub> = 1, R <sub>SET1</sub> = 1.6 kΩ, V <sub>BAT</sub> = 3.6 V	900	1000	1100	mA
Thermal loop regulation	T <sub>REG</sub>			90		°C
Thermal loop entering threshold	T <sub>LOOP_IN</sub>			110		°C
Thermal loop exiting threshold	T <sub>LOOP_OUT</sub>			85		°C
CHG pin sink current	I <sub>CHG</sub>			8		mA
CHG pin low voltage	V <sub>CHGL</sub>				0.4	V
Enable threshold low	V <sub>CENL</sub>				0.6	V
Enable threshold high	V <sub>CENH</sub>		1.4			V
<b>LDO 1, 2</b>						
Output voltage accuracy	V <sub>ACC_L01,2</sub>	I <sub>OUT</sub> = 1 mA to 150 mA, TA = 25 °C	-1.5		1.5	%
		I <sub>OUT</sub> = 1 mA to 150 mA, TA = -40 °C to 85 °C	-2.5		2.5	
Output voltage range	V <sub>RG_L01,2</sub>		0.6		V <sub>SYS</sub> - V <sub>D02</sub>	V
Input voltage	V <sub>LD01,2_IN</sub>			V <sub>SYS</sub>		V
Dropout voltage (Note 2)	V <sub>D0</sub>	I <sub>L01,2</sub> = 150 mA		200	400	mV
Line regulation	$\frac{\Delta V_{L01,2}/V_{L01,2}}{\Delta V_{LD01,2\_IN}}$	V <sub>SYS</sub> = V <sub>L01,2</sub> + 1 to 5.0 V		0.09		%/V
Output current	I <sub>L01,2</sub>	V <sub>L01,2</sub> > 0.6 V	150			mA
Short circuit current	I <sub>SC</sub>	V <sub>L01,2</sub> < 0.4 V		250		mA
Output voltage temperature coefficient	T <sub>L01,2C</sub>			22		ppm/°C
Enable time delay	T <sub>ENL1,2_DLY</sub>			15		μs
Enable threshold low	V <sub>ENL1,2_L</sub>				0.6	V
Enable threshold high	V <sub>ENL1,2_H</sub>		1.4			V
<b>Thermal</b>						
Over-temperature shutdown threshold	T <sub>SD</sub>	Warning thermal threshold		140		°C
Over-temperature shutdown hysteresis	T <sub>HYS</sub>			15		°C

**Note 1:** Performance is guaranteed only under the conditions listed in this table.

**Note 2:** V<sub>D0</sub> is defined as V<sub>IN</sub> - V<sub>OUT</sub> when V<sub>OUT</sub> is 98% of nominal.

### Typical Performance Characteristics

( $V_{IN} = 5\text{ V}$ ,  $V_{BAT} = 3.6\text{ V}$ ,  $V_{SYS} = V_{IN}$  or  $V_{BAT}$ ,  $T_A = -40\text{ }^\circ\text{C}$  to  $+85\text{ }^\circ\text{C}$ , Typical Values are  $T_A = 25\text{ }^\circ\text{C}$ , Unless Otherwise Noted)

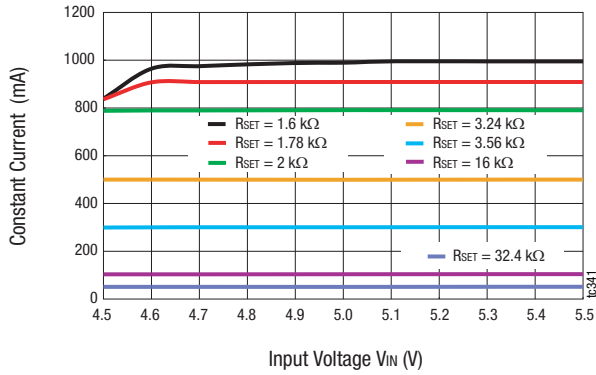


Figure 3. Constant Current vs Input Voltage

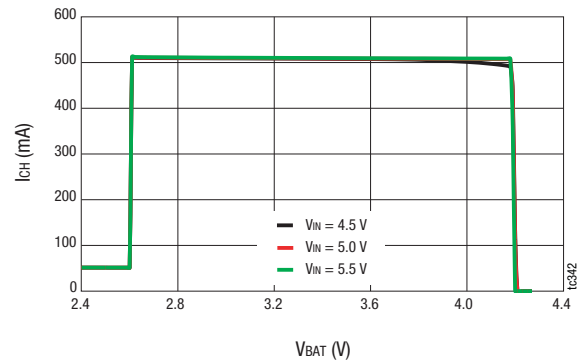


Figure 4. Charge Current vs Battery Voltage ( $R_{SET} = 3.24\text{ k}\Omega$ )

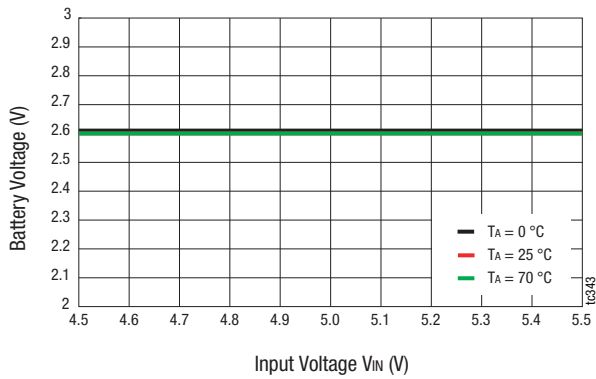


Figure 5. Pre-Conditioning Threshold Voltage vs Input Voltage

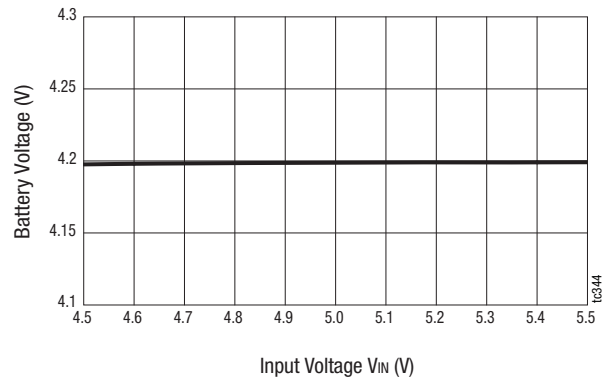
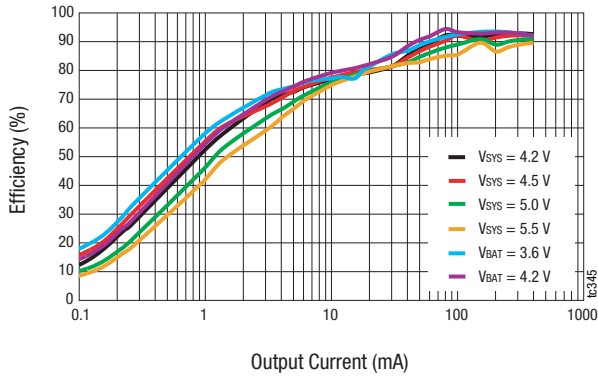
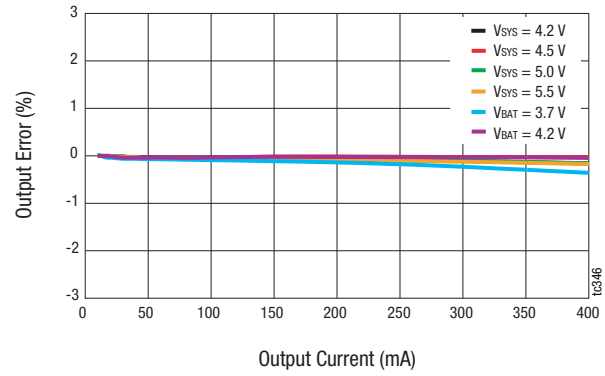


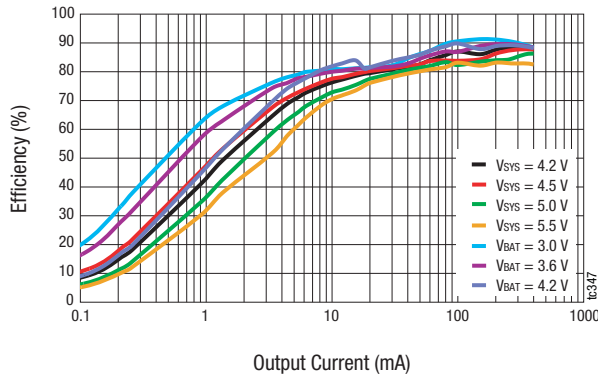
Figure 6. Battery Voltage vs Input Voltage



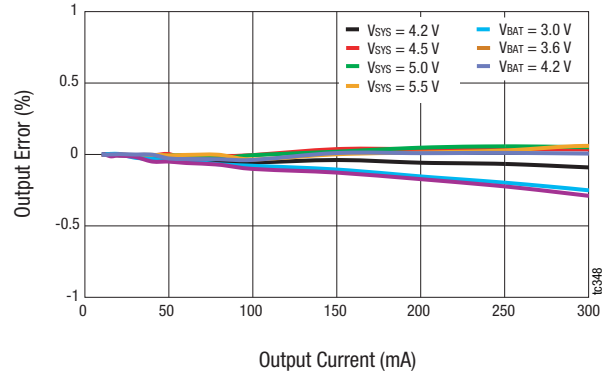
**Figure 7. Step-Down Buck Efficiency vs Output Current**  
( $V_{out} = 3.0\text{ V}$ ,  $L = 2.2\ \mu\text{H}$ )



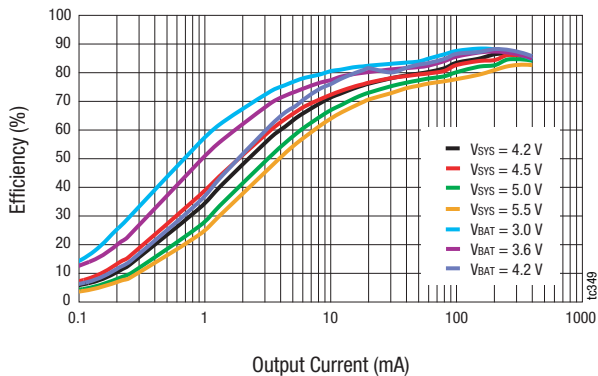
**Figure 8. Buck 1 DC Regulation**  
( $V_{out} = 3.0\text{ V}$ ,  $L = 2.2\ \mu\text{H}$ )



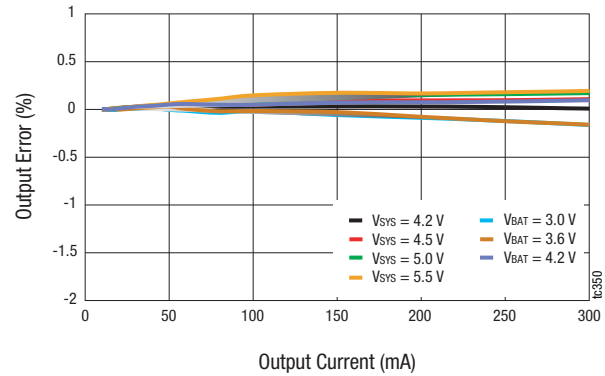
**Figure 9. Step-Down Buck Efficiency vs Output Current**  
( $V_{out} = 1.8\text{ V}$ ,  $L = 2.2\ \mu\text{H}$ )



**Figure 10. Buck 2 DC Regulation**  
( $V_{out} = 1.8\text{ V}$ ,  $L = 2.2\ \mu\text{H}$ )

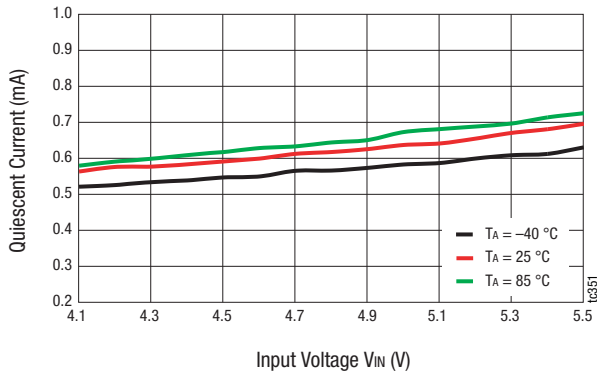


**Figure 11. Step-Down Buck Efficiency vs Output Current**  
( $V_{out} = 1.2\text{ V}$ ,  $L = 2.2\ \mu\text{H}$ )

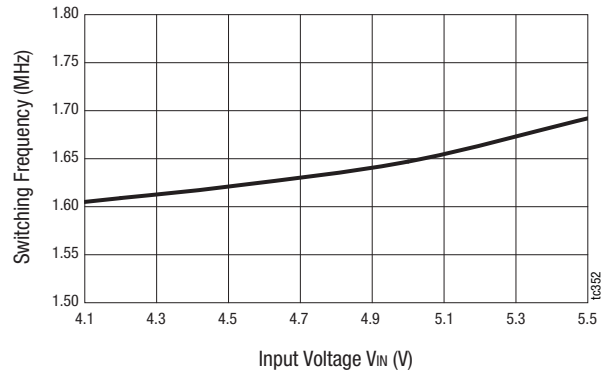


**Figure 12. Buck 3 DC Regulation**  
( $V_{out} = 1.2\text{ V}$ ,  $L = 2.2\ \mu\text{H}$ )

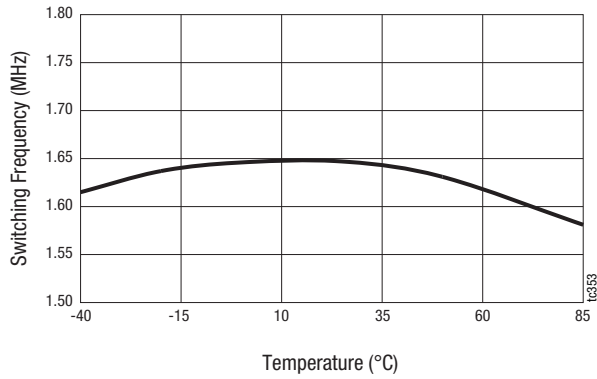




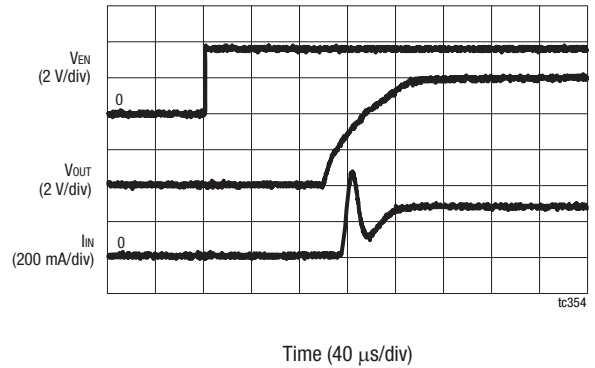
**Figure 13. Quiescent Current vs Input Voltage (Buck 1-3 and LDO 1/2 Enabled, No Load)**



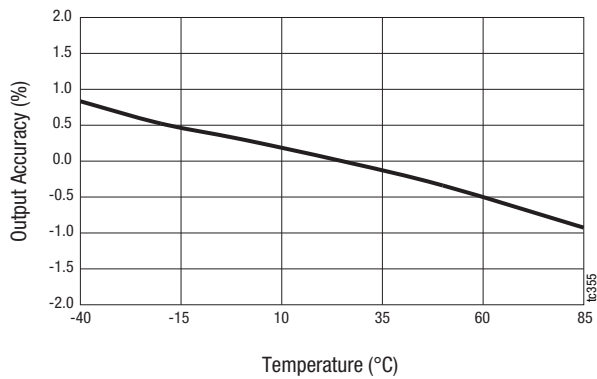
**Figure 14 Frequency vs Input Voltage**



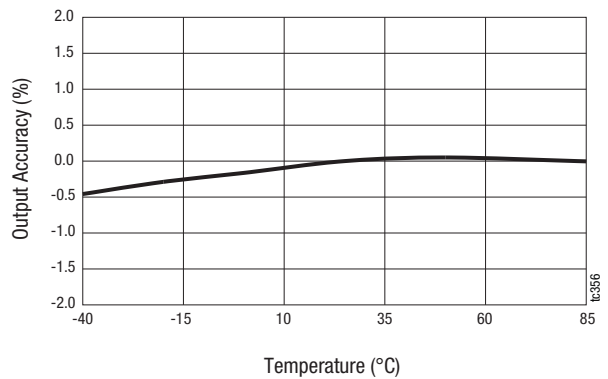
**Figure 15. Switching Frequency vs Temperature (VIN = 5.0 V)**



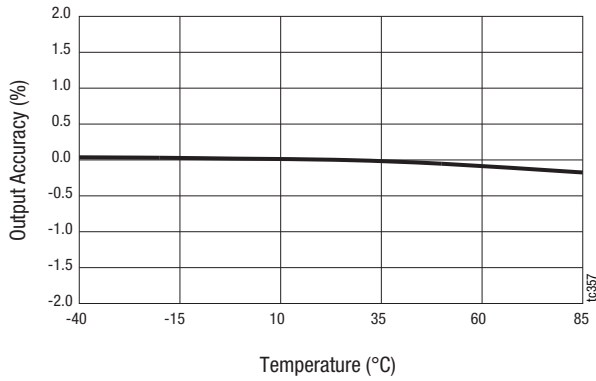
**Figure 16. Buck 1 Soft Start (VIN = 5.0 V, VOUT = 3.0 V, IOUT = 400 mA)**



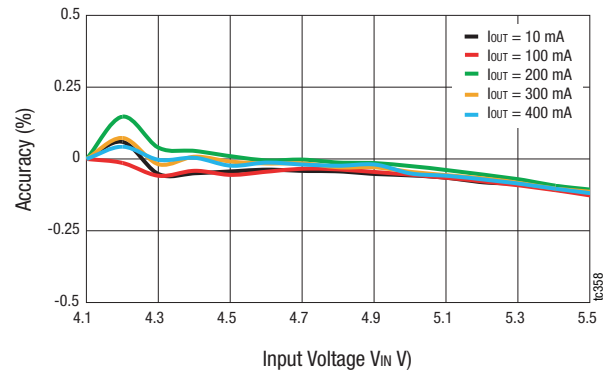
**Figure 17. Buck 1 Output Voltage Accuracy vs Temperature (VIN = 5.0 V, VOUT = 3.0 V, IOUT = 400 mA)**



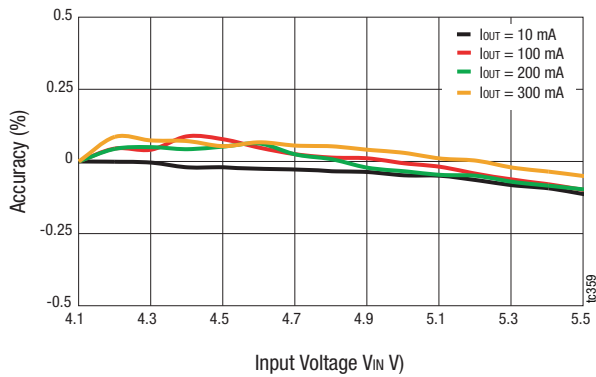
**Figure 18. Buck 2 Output Voltage Accuracy vs Temperature (VIN = 5.0 V, VOUT = 1.8 V, IOUT = 300 mA)**



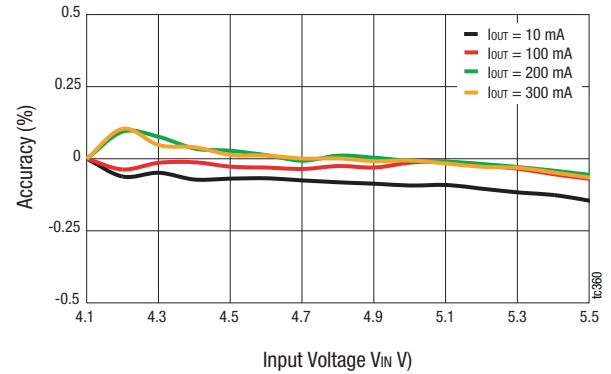
**Figure 19. Buck 3 Output Voltage Accuracy vs Temperature**  
(VIN = 5.0 V, VOUT = 1.2 V, IOUT = 300 mA)



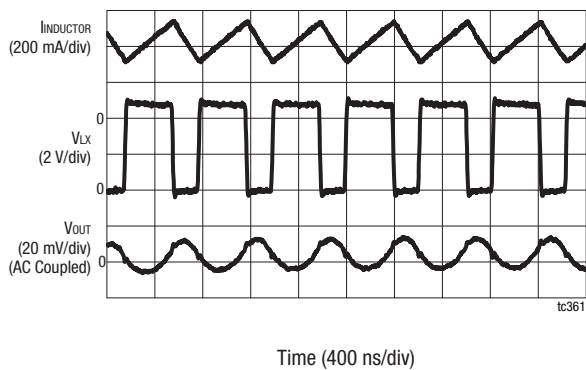
**Figure 20. Buck 1 Line Regulation**  
(VOUT = 3.0 V)



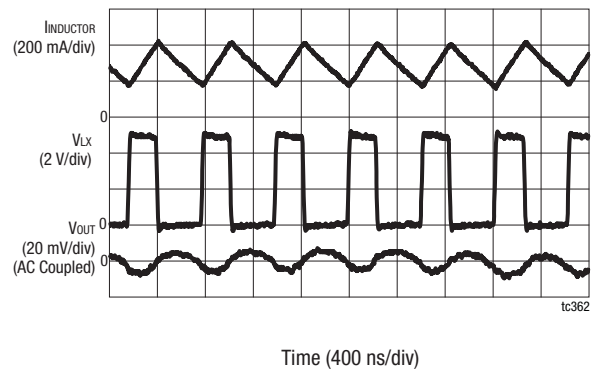
**Figure 21. Buck 2 Line Regulation**  
(VOUT = 1.8 V)



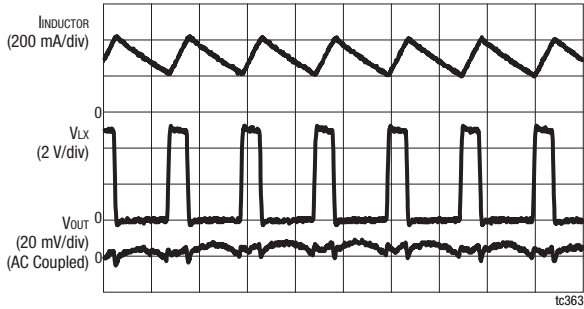
**Figure 22. Buck 1 Line Regulation**  
(VOUT = 1.2 V)



**Figure 23. Buck 1 Output Ripple**  
(VIN = 5.0 V, VOUT = 3.0 V, COUT = 4.7 μF, 400 mA Load)

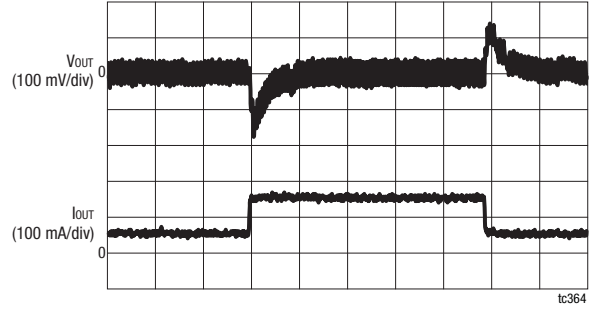


**Figure 24. Buck 2 Output Ripple**  
(VIN = 5.0 V, VOUT = 1.8 V, COUT = 4.7 μF, 300 mA Load)



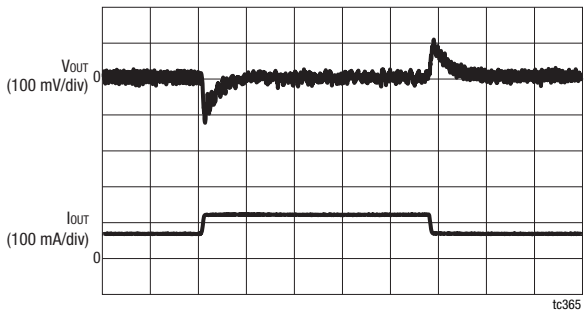
Time (400 ns/div)

**Figure 25. Buck 3 Output Ripple**  
 (VIN = 5.0 V, VOUT = 1.2 V, COUT = 4.7 μF, 300 mA Load)



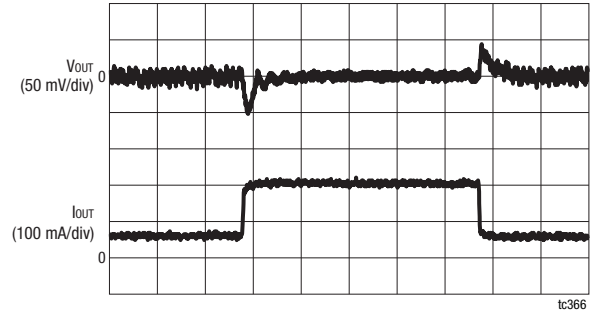
Time (20 μs/div)

**Figure 26. Buck 1 Load Transient Response**  
 (VIN = 5.0 V, VOUT = 3.0 V, 75 mA to 150 mA Load)



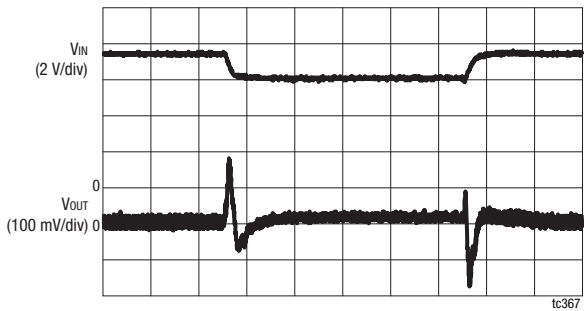
Time (20 μs/div)

**Figure 27. Buck 2 Load Transient Response**  
 (VIN = 5.0 V, VOUT = 1.8 V, 75 mA to 125 mA Load)



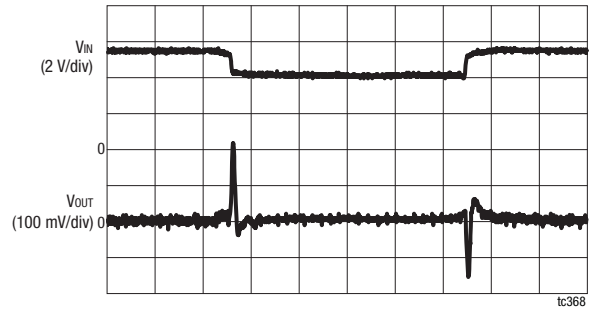
Time (20 μs/div)

**Figure 28. Buck 3 Load Transient Response**  
 (VIN = 5.0 V, VOUT = 1.2 V, 75 mA to 200 mA Load)



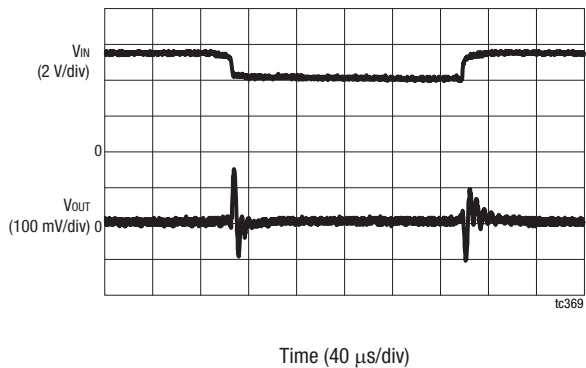
Time (40 μs/div)

**Figure 29. Buck 1 Line Transient Response**  
 (VIN = 4.1 V to 5.0 V, VOUT = 3.0 V, 400 mA Load)

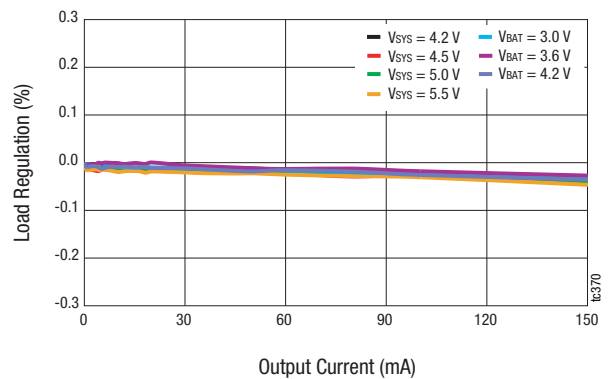


Time (40 μs/div)

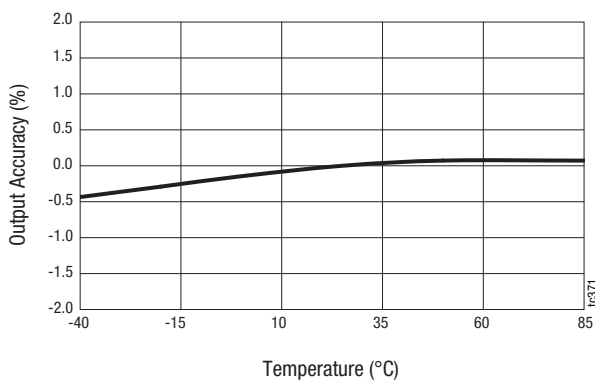
**Figure 30. Buck 2 Line Transient Response**  
 (VIN = 4.1 V to 5.0 V, VOUT = 1.8 V, 300 mA Load)



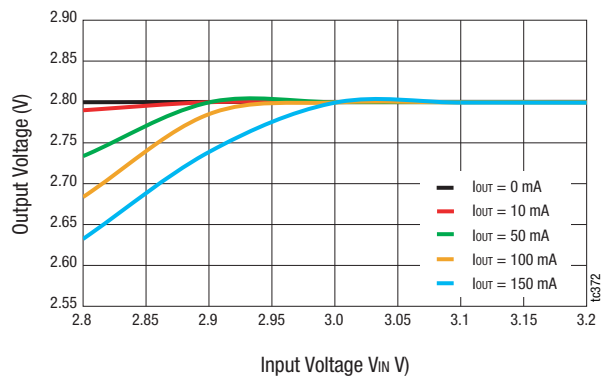
**Figure 31. Buck 3 Line Transient Response**  
 (VIN = 4.1 V to 5.0 V, VOUT = 1.2 V, 300 mA Load)



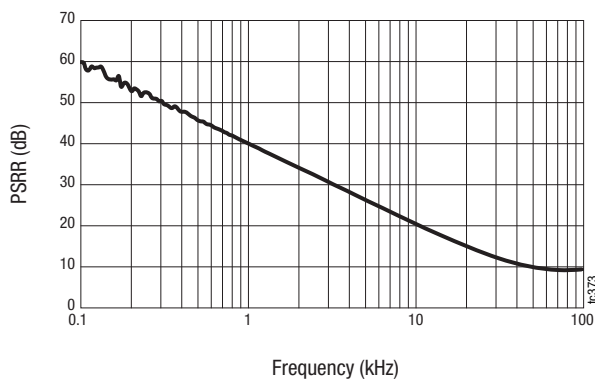
**Figure 32. Load Regulation vs Output Current**



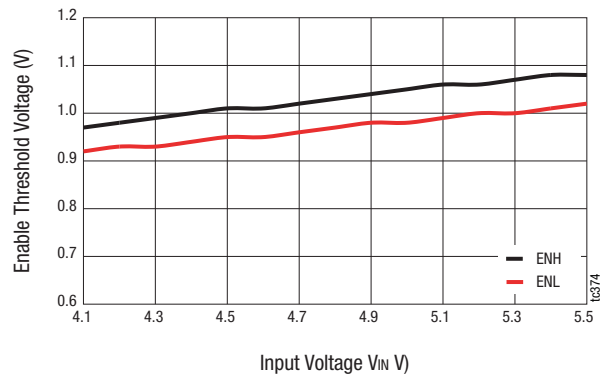
**Figure 33. Output Voltage Accuracy vs. Temperature**  
 (VIN = 5.0 V, VOUT = 2.8 V, IOUT = 150 mA)



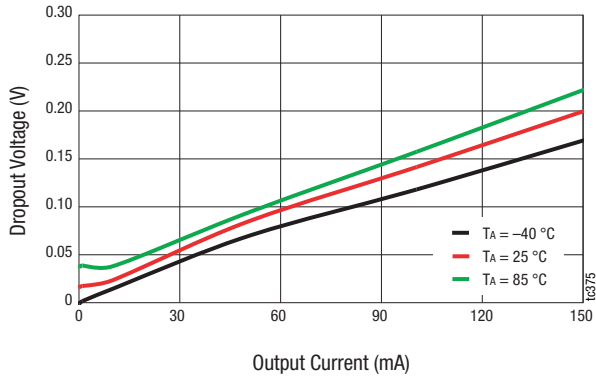
**Figure 34. Dropout Characteristics vs Input Voltage**  
 (VOUT = 2.8 V)



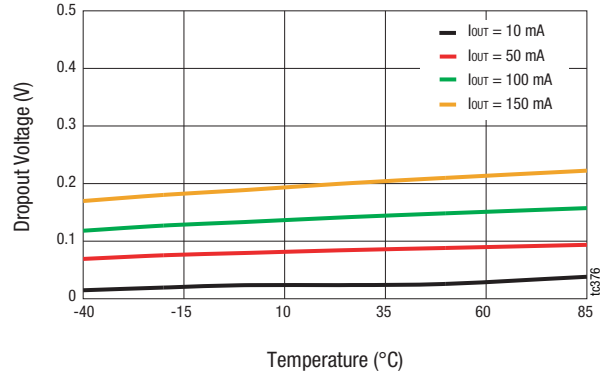
**Figure 35. PSRR vs Frequency**  
 (VIN = 5.0 V, VRIPPLE = 500 mV, 10 mA Load)



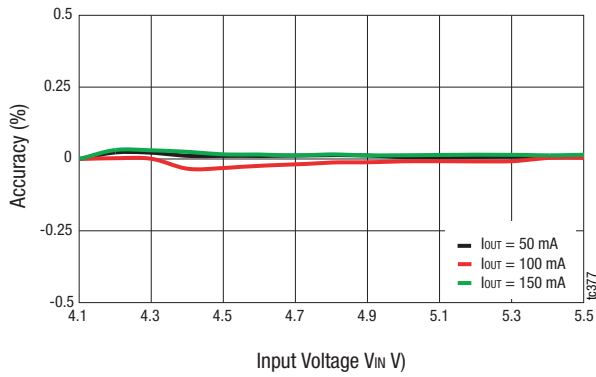
**Figure 36. Enable Threshold Voltage vs Input Voltage (LD02)**



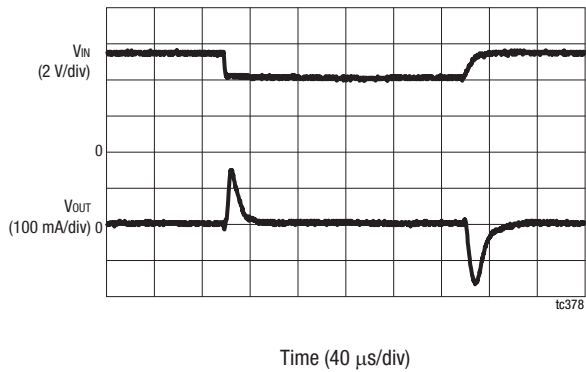
**Figure 37. Dropout Voltage vs Output Current**



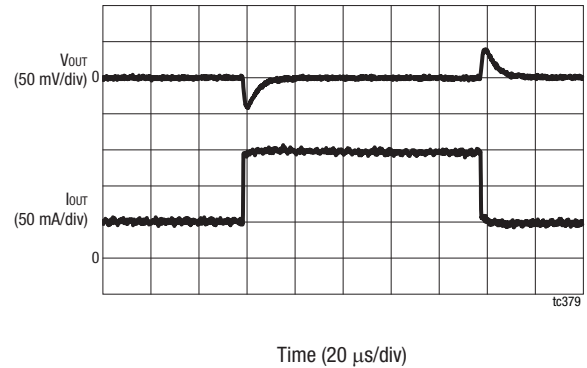
**Figure 38. Dropout Voltage vs Temperature**



**Figure 39. Line Regulation  
(VOUT = 2.8 V)**



**Figure 40. Line Transient Response  
(VIN = 4.1 V to 5.0 V, VOUT = 1.8 V, 150 mA Load)**



**Figure 41. Load Transient Response  
(VIN = 5.0 V, VOUT = 2.8 V, 50 mA to 150 mA Load)**

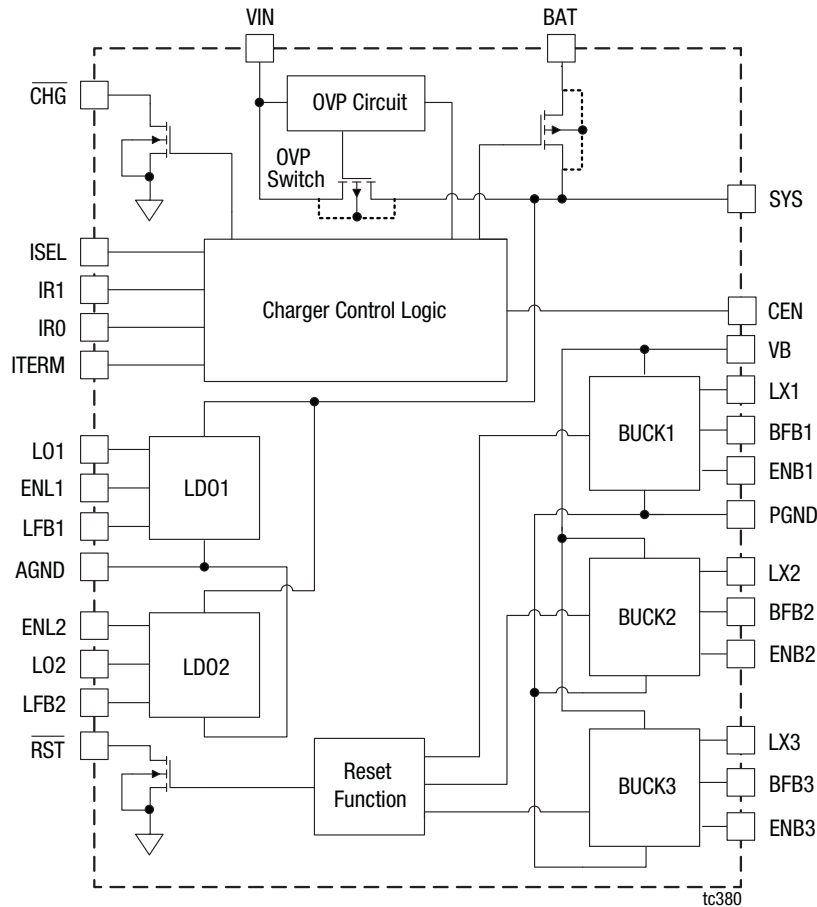


Figure 42. AAT3607 Functional Block Diagram

### Functional Description

The AAT3607 is a complete power management solution. It seamlessly integrates a battery charger with three step-down converters and two low-dropout regulators to provide power from a wall adapter, a USB port, or a single-cell Lithium Ion/Polymer battery. Internal load switches allow the converters to operate from the best available power source.

If only the battery is available, the voltage converters are powered directly from the battery through a 100 mΩ load switch. The charger goes into sleep mode and draws less than 1 μA quiescent current. If the system is connected to a wall adapter, the voltage converters are powered directly from the adapter through the Over-Voltage Protection (OVP) switch with on-resistance of 180 mΩ and the battery is disconnected from the voltage converters' inputs. This allows the system to operate regardless of the charging state of the battery, or to operate with no battery.

The charger circuitry offers flexible power distribution from an AC/DC adapter or a current-limited USB source to the battery and system load. The battery is charged with any available power not used by the system load. If a system load peak

exceeds the input current limit, supplemental current is taken from the battery.

Figure 42 shows the functional block diagram for the AAT3607.

### Battery Charger and SYS

The charger seamlessly distributes power between the current-limited external input, the battery, and the system load. The basic functions performed with the battery and external power source are:

- If the system load requirements are less than the input current limit, the battery is charged with residual power from the input source.
- If the system load requirements exceed the input current limit, the battery supplies supplemental current to the load through the internal system load switch.
- If the battery is connected and there is no external power input, SYS is powered only from the battery.
- If an external power input is connected and there is no battery, the SYS is powered from the external power input.

- A thermal-limiting circuit reduces the battery charge rate from the external power source current to prevent the IC from overheating.

VIN is the power input pin that supplies the system (SYS) up to 1 A through an over-voltage protection switch. The battery charge current level is selected with the ISEL input pin. The two current levels are designed for use with AC/DC wall adapters and current-limited USB power sources. The operating voltage range for VIN is 4.1 V to 5.5 V.

When the input voltage is below the under-voltage threshold or below the battery voltage, it is considered to be invalid. The power input is disconnected when the input voltage is invalid.

**Battery Charger**

Battery charging commences only after the AAT3607 battery charger enable pin (CEN) is turned on and the charger circuits check for several conditions in order to maintain a safe charging environment. The input supply must be above the minimum operating voltage (UVLO) and must be within specifications. The OVP function ensures that only safe input voltages within specifications are connected to the battery charger. Otherwise, the unsafe input voltage is completely disconnected from the battery charger terminals.

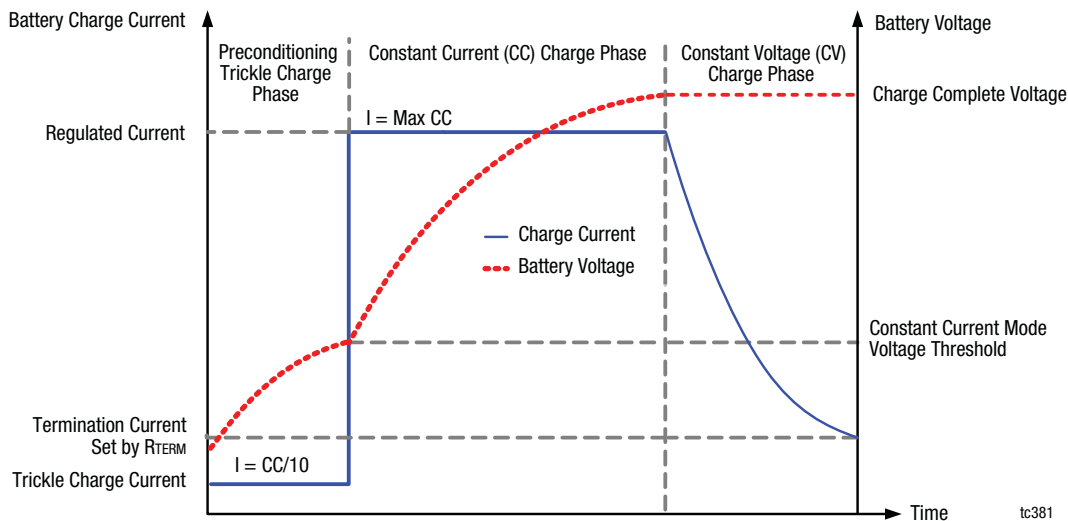
When the battery is connected to the BAT pin, the battery charger checks the condition of the battery and determines which charging mode to apply. If the battery voltage is below VMIN, the battery charger initiates trickle charge mode and charges the battery at 10% of the programmed constant-current magnitude. For example, if the programmed current is 500 mA, the trickle charge current will be 50mA. Trickle charge is a safety precaution for a deeply discharged cell and also reduces the power dissipation in the internal series pass MOSFET when the input-output voltage differential is at its highest.

Trickle charge mode continues until the battery voltage reaches 2.6 V. At this point the battery charger switches to constant current charge mode. The current level for this mode is programmed by the IR1 and IRO pins using a resistor connected from the pin to ground and selected by the ISET pin.

Programmed current can be set from a minimum of 100 mA up to a maximum of 1 A. Constant current charge mode continues until the battery voltage reaches the voltage regulation point VBAT\_REG. When the battery voltage reaches the regulation voltage (VBAT\_REG), the battery charger transitions to constant voltage mode. VBAT\_REG is factory programmed to 4.2 V (nominal). Charging in constant voltage mode continues until the charge current has fallen to the end of charge termination current. The charge termination current level is programmed by the ITERM pin with a resistor connected to this pin to ground. Floating this pin will result in the termination current set to 10% of IRO or IR1. Connecting this pin to ground will result in the lowest termination current.

After the charge cycle is complete, the battery charger turns off the series pass device and automatically goes into a power saving sleep mode. During this time, the series pass device blocks current in both directions to prevent the battery from discharging through the battery charger.

The battery charger remains in sleep mode even if the charger source is disconnected. It comes out of sleep mode when either the battery terminal voltage drops below the (VBAT\_REG – 0.1 V) threshold or the charger CEN pin is recycled, or the charging source is reconnected. In all cases, the battery charger monitors all parameters and resumes charging in the most appropriate mode. When no automatic charge reduction mode or digital thermal loop is triggered, the charge profile is controlled as shown in Figure 43. The AAT3607 also includes an integrated reverse blocking function.



**Figure 43. Charge Current vs. Battery Voltage Profile During Charging Phases**

### Thermal Loop Control

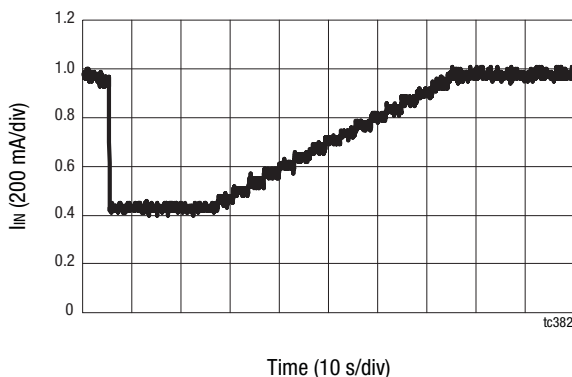
The actual maximum charging current is a function of charge adapter input voltage, the state of charge of the battery at the moment of charge, the ambient temperature, and the thermal impedance of the package. The maximum programmable current may not be achievable under all operating parameters. One issue to consider is the amount of current being provided to the SYS from VIN and at the same time being provided as charge current to the battery from VIN. A reduction in the charge current is designed when the device temperature is too high through the digital thermal loop of the charger.

To protect the linear charging IC from thermal problems, a special thermal loop control system is used to maximize charging current. The thermal management system measures the internal circuit die temperature and reduces the fast charge current when the die exceeds the preset internal temperature control threshold. Once the thermal loop control becomes active, the fast charge current is initially reduced by a factor of 0.44.

The initial thermal loop current can be estimated by the following equation:

$$I_{TLOOP} = I_{CC} \times 0.44$$

The thermal loop control re-evaluates the circuit die temperature every three seconds and raises the fast charge current in small steps to the full fast charge current level. Figure 44 illustrates the thermal loop function at 1 A fast charge current as the ambient temperature increases and recovers. In this manner the thermal loop controls the system charge level, and the AAT3607 provides the highest level of constant current in the fast charge mode for any possible valid ambient temperature condition.



**Figure 44. Digital Thermal Loop Function at 1 A Fast Charge Current with Ambient Temperature Increasing and Recovering**

### OVP Switch

In normal operation the OVP switch acts as a load switch, connecting and disconnecting the power supply from VIN. A low resistance MOSFET is used to minimize the voltage drop between the voltage source and the charger and to reduce power dissipation. When the voltage on the input exceeds the 6.25 V voltage limit, the device immediately turns off the internal OVP switch, disconnecting the load from the abnormal voltage and preventing damage to any downstream components. If an over-voltage condition is applied when the device is enabled, then the switch remains OFF.

On initial power-up, if  $UVLO < V_{IN} < 6.25 V$ , the OVP switch turns on after an 180  $\mu s$  typical internal delay, if  $V_{IN} < UVLO$  or if  $V_{OVP} > 6.25 V$ , the OVP switch is held off.

If  $V_{IN} > 6.25 V$ , the OVP switch is held off. After  $V_{IN} < (6.25 V - \text{hysteresis})$ , the OVP switch turns on after an 180  $\mu s$  typical internal delay.

### Synchronous Step-Down Converter

The AAT3607 contains two high-performance 300 mA and one high-performance 400 mA, 1.6 MHz synchronous step-down converters. The step-down converters operate to ensure high efficiency performance over all load conditions. All three output voltages are programmable by external resistor dividers to feedback the output voltage and compare it to the internal 0.6 V reference voltage.

The input voltage range is from 4.1 V to 5.5 V, and the output voltage is programmable. Power devices are sized for 300 mA and 400 mA current capability while maintaining over 90% efficiency at full load. High efficiency is maintained at lower currents.

A high DC gain error amplifier with internal compensation controls the output. It provides excellent transient response and load/line regulation. Transient response time is typically less than 20  $\mu s$ . The converter has soft start control to limit inrush current.

Apart from the input capacitor, only a small L-C filter is required at the output side for the step-down converters to operate properly. Typically, a 2.2  $\mu H$  inductor or a 4.7  $\mu F$  ceramic capacitor is recommended for low output voltage ripple and small component size.



### Control Loop

The converter is a peak current mode step-down converter. The inner, wide bandwidth loop controls the inductor peak current. The inductor current is sensed through the P-channel MOSFET (high side) and is also used for short-circuit and overload protection. A fixed slope compensation signal is added to the sensed current to maintain stability for duty cycles greater than 50%. The peak current mode loop appears as a voltage programmed current source in parallel with the output capacitor. The output of the voltage error amplifier programs the current mode loop for the necessary peak inductor current to force a constant output voltage for all load and line conditions. The voltage feedback resistive divider is external and the error amplifier reference voltage is 0.6 V. The voltage loop has a high DC gain making for excellent DC load and line regulation. The internal voltage loop compensation is located at the output of the transconductance voltage error amplifier.

### Soft Start

Soft start increases the inductor current limit point linearly when the input voltage or enable input is applied. It limits the current surge seen at the input and eliminates output voltage overshoot.

### Active Discharge in Shutdown

All AAT3607 synchronous buck converters have an internal 1 k $\Omega$  resistor that discharges the output capacitor when the converter is off at LX node. The discharge resistors ensure that the load circuitry powers down quickly and completely. The internal discharge resistors are connected when a converter is disabled and when the device is in UVLO with an input voltage greater than 1.0 V. With an input voltage less than 1.0 V, the internal discharge resistors are not activated.

### Synchronous Buck Converters Phase Shift

Converter phase shifting significantly reduces both input and output ripple current. Reducing ripple current allows for less input and output capacitance, reduces power dissipation, and improves efficiency. Figure 45 shows a comparison of the two approaches.

### Current Limit and Over-Temperature Protection

Peak input current is limited for overload conditions. As load impedance decreases and the output voltage falls closer to zero, more power is dissipated internally, raising the device temperature. Thermal protection completely disables switching when internal dissipation becomes excessive, protecting the device from damage. The junction over-temperature threshold is 140 °C with 15 °C of hysteresis. If the junction temperature

of the chip rises above the temperature shutdown threshold, the AAT3607 is forced to turn off and restarts when the over-temperature condition is removed.

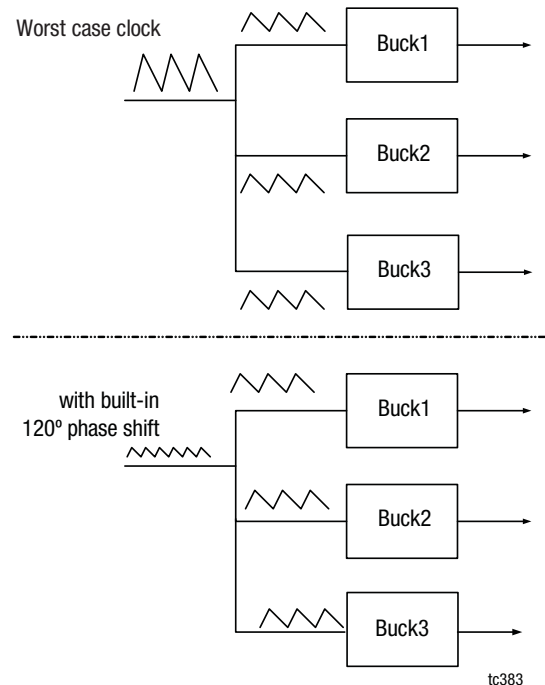


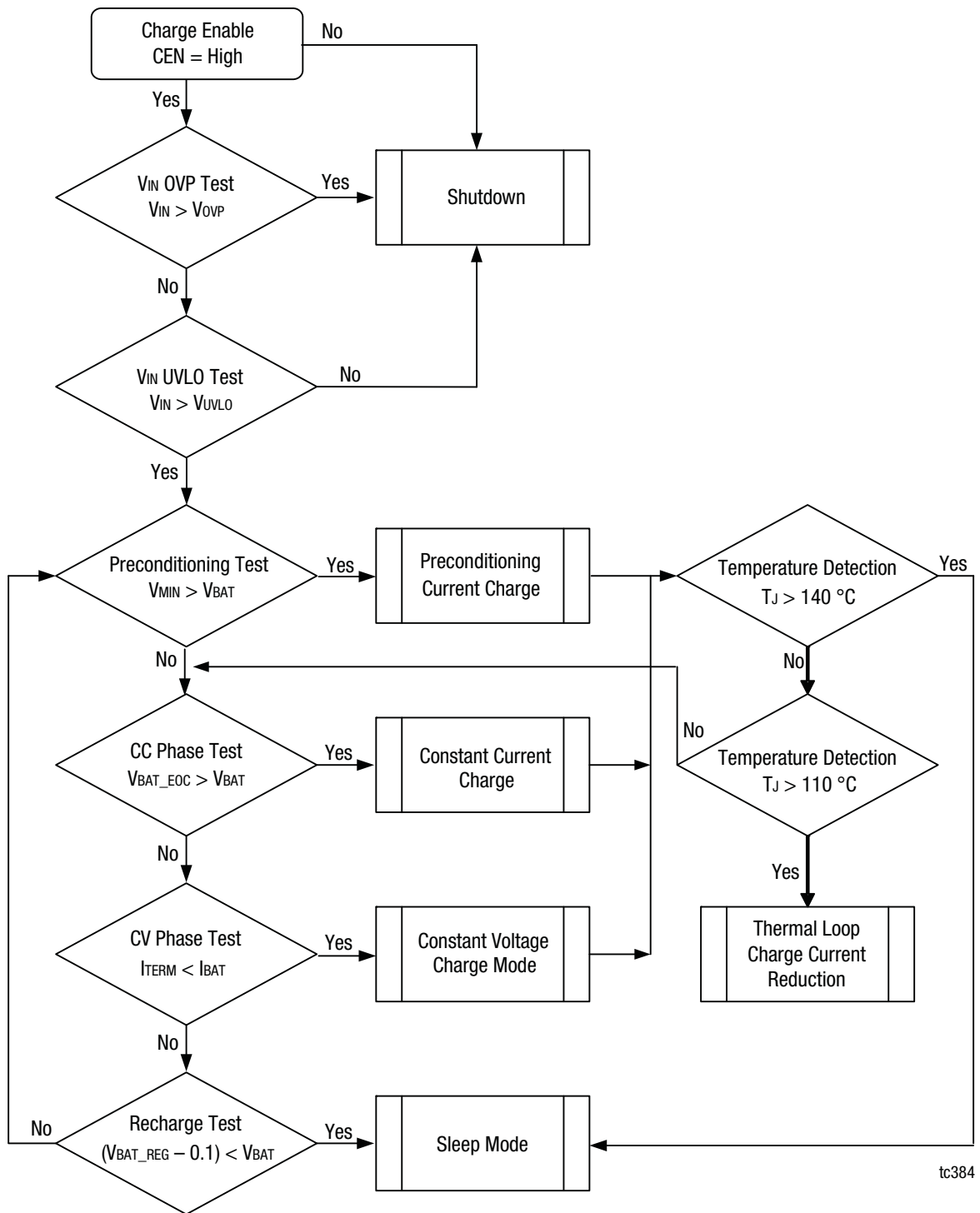
Figure 45. Buck Converter Phase Shifting

### Low Dropout Regulator

The advanced circuit design of the linear regulator has been specifically optimized for very fast startup and shutdown timing. This proprietary LDO has also been tailored for superior transient response characteristics. These traits are particularly important for applications that require fast power supply timing.

The high-speed turn-on capability is enabled through the implementation of a fast-start control circuit, which accelerates the power-up behavior of fundamental control and feedback circuits within the LDO regulator. Fast turn-off time response is achieved by an active output pull-down circuit, which is enabled when the LDO regulator is placed in shutdown mode. This active fast shutdown circuit has no adverse effect on normal device operation. The LDO regulator output has been specifically optimized to function with low cost, low ESR ceramic capacitors. However, the design allows for operation over a wide range of capacitor types.

The regulator comes with complete short circuit and thermal protection. The combination of these two internal protection circuits gives a comprehensive safety system to guard against extreme adverse operating conditions.



tc384

Figure 46. Battery Charger Operation Flowchart

## Application Information

### Battery Charger

Figure 46 shows the battery charger operation flowchart.

#### Programmable Charge Current

The AAT3607 has two pins (IRO and IR1) for two kinds of charge current level setting selected by ISEL. When ISEL is low, the constant charge current is set by the resistor connected between IRO and ground; when ISEL is high, it is set by the resistor between IR1 and ground. The programmed charge current up to 1 A can be calculated by:

$$I_{CH\_CC} = \frac{2}{R_{SET}} \times KI_{SET}$$

$$R_{SET} = \frac{2}{I_{CH\_CC}} \times KI_{SET}$$

Among them, KISET = 800. Table 5 gives the recommended 1% tolerance metal film resistance values for a desired constant current charge level.

**Table 5. Standard 1% Metal Film Resistor Values for Constant Current Setting**

ICH_CC (mA)	RSET (kΩ)
50	32.4
75	21.5
100	16
200	8.06
300	5.36
400	4.02
500	3.24
600	2.67
700	2.32
800	2
900	1.78
1000	1.60

#### Programmable Charge Termination Current Percentage

The charge termination current percentage of fast charge current can be programmed by an external resistor connected between ITERM and GND. This resistance can be calculated by

$$R_{TERM} = 133 \times \frac{I_{CH\_TERM}}{I_{CH\_CC}} \times 10^3$$

when ICH\_CC is the fast charge current. For example, if the design's intended charge termination current is 100 mA for a 500 mA fast charge current set by IRO, then

$$R_{TERM} = 133 \times \frac{100mA}{500mA} \times 10^3 = 26.7k\Omega$$

At this RTERM setting, when the other fast charge current is 300 mA set by IR1, according to the same charge termination current percentage (20%), the ICH\_TERM is 60 mA when IR1 is active to set the fast charge current by ISEL = high.

Floating the ITERM pin sets the termination charge current to a default 10% of the fast charge current.

Table 6 shows some standard metal resistor values for different charge termination current percentages.

**Table 6. Standard 1% Metal Film Resistor Values for Charge Termination Current Percentage Setting.**

Charge Termination Current Percentage (%)	RTERM (kΩ)
10	13.3 or float
15	20
20	26.7
25	34
30	41.2
35	47.5
40	53.6
45	60.4
50	66.5

#### Charge Status Indication

The AAT3607 has one status LED driver output with open drain structure. This single LED can indicate simple functions such as battery charging, charge complete, and charge disabled as shown in Table 7.

**Table 7. LED Status at Different Charge States**

Description	EN	LED Status
Battery charging	high	on
Charge complete	high	off
Charge disabled	low	off

#### Reverse Blocking

The AAT3607 includes internal circuitry that eliminates the need for series blocking diodes, reducing solution size and cost as well as dropout voltage relative to conventional battery chargers. When the input supply is removed or when VIN goes below the AAT3607 Under-Voltage Lockout (UVLO) voltage, or when VIN drops below VBAT, the AAT3607 automatically reconfigures its power switches to minimize current drain from the battery.

**Charge Current Reduction**

In many instances, product system designers do not know the real properties of potential ports used to supply power to the battery charger. Typically, powered USB ports found on desktop and notebook PCs should supply up to 500 mA. In the event the input power being used to supply the charger is unable to provide the programmed fast charge current or if the system under charge must also share supply current with other functions, the AAT3607 automatically reduces charge current to maintain SYS voltage not less than 4.5 V typical value.

**Step-down Converter**

**Programmable Output Voltage**

For applications requiring an adjustable output voltage, the AAT3607 buck converter outputs can be externally programmed. Resistors R1 and R2 of Figure 47 program the output to regulate at a voltage higher than 0.6 V. To limit the bias current required for the external feedback resistor string while maintaining good noise immunity, the minimum suggested value for R1 is 59 kΩ. Although a larger value further reduces quiescent current, it also increases the impedance of the feedback node, making it more sensitive to external noise and interference. Table 8 summarizes the resistor values for various output voltages with R1 set to either 59 kΩ for good noise immunity or 316 kΩ for reduced no load input current.

The AAT3607, combined with an external feed-forward capacitor (C2 in Figure 47), delivers enhanced transient response for extreme pulsed load applications. The addition of the feed-forward capacitor typically requires a larger output capacitor C3 for stability. The external resistor sets the output voltage according to the following equation:

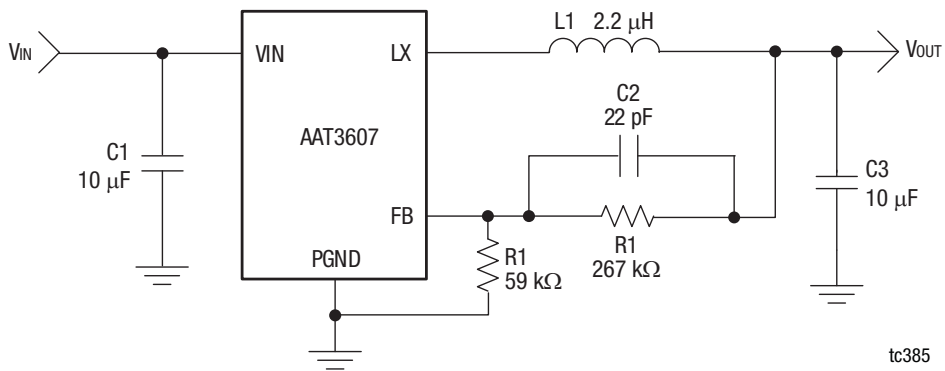
$$V_{OUT} = 0.6V \times \left(1 + \frac{R2}{R1}\right)$$

or

$$R2 = \left[ \left( \frac{V_{OUT}}{0.6V} \right) - 1 \right] \times R1$$

**Table 8. Resistor Selection for Output Voltage Setting; Standard 1% Resistor Values Substituted Closest to the Calculated Values**

V <sub>OUT</sub> (V)	R1 = 59 kΩ R2 (kΩ)	R1 = 316 kΩ R2 (kΩ)
0.8	19.6	105
0.9	29.4	158
1.0	39.2	210
1.1	49.9	261
1.2	59.0	316
1.3	68.1	365
1.4	78.7	422
1.5	88.7	475
1.8	118	634
1.85	124	655
2.0	137	732
2.5	187	1000
3.3	267	1430



**Figure 47. AAT3607 Basic Application Circuit with Programmable Output Voltage**

## Low Dropout (LDO) Regulator

### Programmable Output Voltage

For applications requiring an adjustable output voltage, the AAT3607 LDO regulator outputs can also be externally programmed similar to the buck converter outputs. The feedback voltage is also set to 0.6 V, so the values of R1 and R2 are determined by the equation:

$$V_{OUT} = 0.6V \times \left(1 + \frac{R2}{R1}\right)$$

or

$$R2 = \left[\left(\frac{V_{OUT}}{0.6V}\right) - 1\right] \times R1$$

### Inductor Selection

The step-down converter uses peak current mode control with slope compensation to maintain stability for duty cycles greater than 50%. The output inductor value must be selected so the inductor current down slope meets the internal slope compensation requirements. For most designs, the AAT3607 operates with inductor values of 2.2  $\mu$ H to 3.3  $\mu$ H. Inductors with lower inductance values are physically smaller but generate higher inductor current ripple leading to higher output voltage ripple.

Manufacturer specifications list both the inductor DC current rating, which is a thermal limitation, and the peak current rating, which is determined by the saturation characteristics. The inductor should not show any appreciable saturation under normal load conditions.

Some inductors may meet the peak and average current ratings but still result in excessive losses due to a high DCR.

Always consider the losses associated with the DCR and its effect on the total converter efficiency when selecting an inductor.

### Input Capacitor

Select a 10  $\mu$ F to 22  $\mu$ F X7R or X5R ceramic capacitor for the input. To estimate the required input capacitor size, determine the acceptable input ripple level (V<sub>PP</sub>) and solve for C<sub>IN</sub>. The calculated value varies with input voltage and is a maximum when V<sub>IN</sub> is double the output voltage.

$$C_{IN} = \frac{\frac{V_{OUT}}{V_{IN}} \times \left(1 - \frac{V_{OUT}}{V_{IN}}\right)}{\left(\frac{V_{PP}}{I_{OUT}} - ESR\right) \times f_{SW}}$$

Always examine the ceramic capacitor DC voltage coefficient characteristics when selecting the proper value. For example, the capacitance of a 10  $\mu$ F, 6.3 V, X5R ceramic capacitor with 5.0 V DC applied is actually about 6  $\mu$ F.

The maximum input capacitor RMS current for a single converter is:

$$I_{RMS} = I_{OUT} \times \sqrt{\frac{V_{OUT}}{V_{IN}} \times \left(1 - \frac{V_{OUT}}{V_{IN}}\right)}$$

The input capacitor provides a low impedance loop for the edges of pulsed current drawn by the AAT3607. Low ESR/ESL X7R and X5R ceramic capacitors are ideal for this function. To minimize parasitic inductances, the capacitor should be placed as closely as possible to the IC. This keeps the high frequency content of the input current localized, minimizing EMI and input voltage ripple.

In applications where the input power source lead inductance cannot be reduced to a level that does not affect the converter performance, a high ESR tantalum or aluminum electrolytic should be placed in parallel with the low ESR/ESL bypass ceramic capacitor. This dampens the high Q network and stabilizes the system.

### Output Capacitor

The output capacitor limits the output ripple and provides holdup during large load transitions. A typical 4.7  $\mu$ F X5R or X7R ceramic capacitor typically provides sufficient bulk capacitance to stabilize the output during large load transitions and has the ESR and ESL characteristics necessary for low output ripple.

The output voltage droop due to a load transient is dominated by the capacitance of the ceramic output capacitor. During a step increase in load current, the ceramic output capacitor alone supplies the load current until the loop responds. Within two or three switching cycles, the loop responds and the inductor current increases to match the load current demand. The relationship of the output voltage droop during the three switching cycles to the output capacitance can be estimated by:

$$C_{OUT} = \frac{3 \times \Delta I_{LOAD}}{V_{DROOP} \times f_{SW}}$$

Once the average inductor current increases to the DC load level, the output voltage recovers. The above equation establishes a limit on the minimum value for the output capacitor with respect to load transients.

### Power Calculations

There are three types of losses associated with the AAT3607 step-down converters: switching losses, conduction losses, and quiescent current losses. Conduction losses are associated with the  $R_{DS(ON)}$  characteristics of the power output switching devices. Switching losses are dominated by the gate charge of the power output switching devices. At full load, with Continuous Conduction Mode (CCM), a simplified form of the losses is given by:

$$P_{BUCK} = I_{OUT}^2 \left[ R_{DS(ON)P} \times \frac{V_{OUT}}{V_{IN}} + R_{DS(ON)N} \times \left( 1 - \frac{V_{OUT}}{V_{IN}} \right) \right] + t_{SW} \times f_S \times I_{OUT} \times V_{IN} + I_Q \times V_{IN}$$

$I_Q$  is the step-down converter quiescent current.  $t_{SW}$  is the switching time,  $R_{DS(ON)P}$  and  $R_{DS(ON)N}$  are the high side and low side switching MOSFETs' on-resistance.  $V_{IN}$ ,  $V_{OUT}$  and  $I_{OUT}$  are the input voltage, the output voltage and the load current.

Since  $R_{DS(ON)}$ , quiescent current, and switching losses all vary with input voltage, the total losses should be investigated over the complete input voltage range.

For all the LDOs,

$$P_{D(MAX)} = (V_{IN} - V_{OUT}) \times I_{OUT(MAX)}$$

The total power losses of step-down converter and LDOs can be expressed as

$$P_{TOTAL} = P_{BUCK} + P_{D(MAX)}$$

Given the total losses, the maximum junction temperature can be derived from the  $\theta_{JA}$  for the package.

$$T_{J(MAX)} = P_{TOTAL} \times \theta_{JA} + T_A$$

### Layout Considerations

When laying out the PC board of the AAT3607, follow the guidelines below:

- For the best results physically place the battery pack as close to the AAT3607 BAT pin as possible.
- To minimize voltage drops on the PCB, keep the high current carrying traces adequately wide.
- For maximum power dissipation of the AAT3607 TQFN package, the exposed pad should be soldered to the board ground plane to further increase local heat dissipation.
- A ground pad below the exposed pad is strongly recommended.

### Evaluation Board Description

The AAT3607 Evaluation Board is used to test the AAT3607 power management unit. A schematic diagram for the AAT3607 Evaluation Board is provided in Figure 48, and the board layer details are shown in Figure 49. The actual bill of materials required for the AAT3607 Evaluation Board is shown in Table 9.

### Package Information

Package dimensions for the 28-pin TQFN package are shown in Figure 50. Tape and reel dimensions are shown in Figure 51.

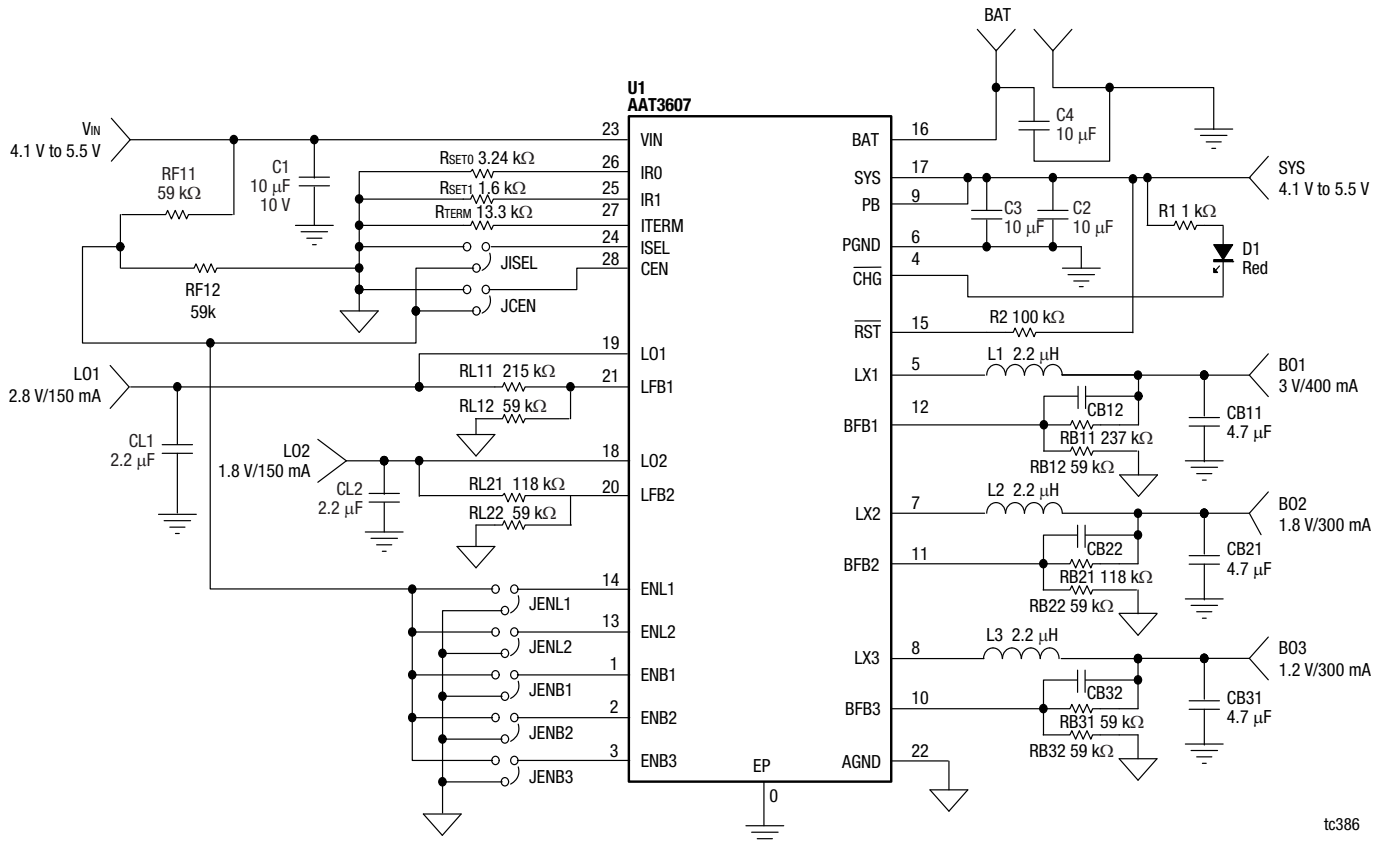
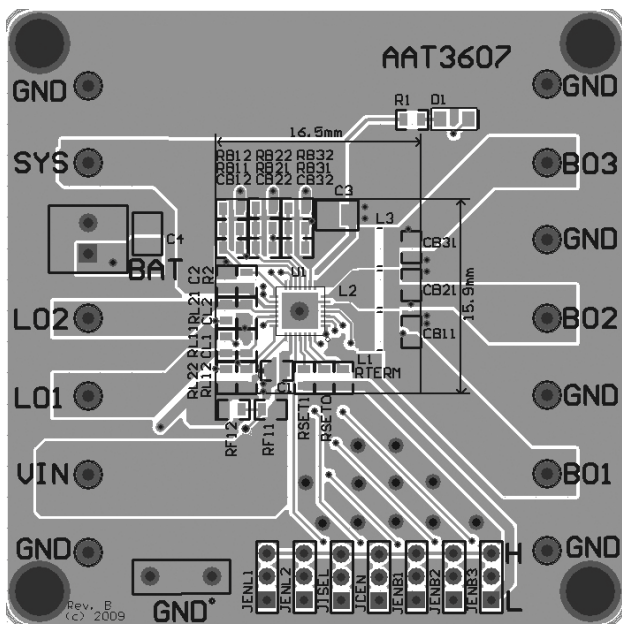
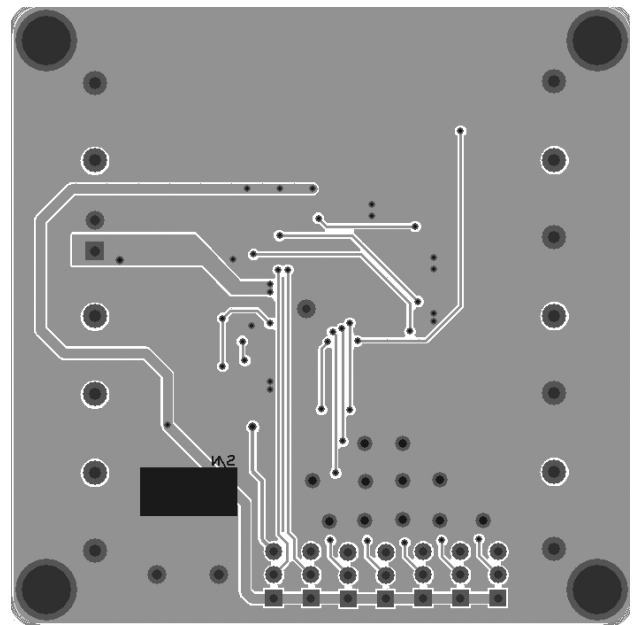


Figure 48. AAT3607 Evaluation Board Schematic



(a) Top Layer



(b) Bottom Layer

Figure 49. AAT3607 Evaluation Board Layer Details

**Table 9. AAT3607 Evaluation Board Bill of Materials (BOM)**

Component	Part Number	Description	Manufacturer
U1	AAT3607	PMU with OVP Dynamic Li-ion Charger	Skyworks
C1, C2, C3, C4	GRM21BR71A106KE51	Cap Ceramic, 10 $\mu$ F, 0805 X7R, 10 V, 10%	Murata
CB11, CB21, CB31	GRM188R60J475KE19	Cap Ceramic, 4.7 $\mu$ F, 0603 X5R, 6.3 V, 10%	Murata
CL1, CL2	GCM188R70J225KE22	Cap Ceramic, 2.2 $\mu$ F, 0603 X7R, 6.3 V, 10%	Murata
CB12, CB22, CB32	Not populated		
L1, L2, L3	LQH3NPN2R2NM0L	2.2 $\mu$ H, 73 m $\Omega$ , 1.25 A, 20%	Murata
R1	RC0603FR-071KL	Res, 1 k $\Omega$ , 1/10W, 1% 0603 SMD	Yageo
R2	RC0603FR-07100KL	Res, 100 k $\Omega$ , 1/10W, 1% 0603 SMD	Yageo
RB11	RC0603FR-07237KL	Res, 237 k $\Omega$ , 1/10W, 1% 0603 SMD	Yageo
RB12, RB22, RB31, RB32, RF11, RF12, RL12, RL22	RC0603FR-0759KL	Res, 59 k $\Omega$ , 1/10W, 1% 0603 SMD	Yageo
RB21, RL21	RC0603FR-07118KL	Res, 118 k $\Omega$ , 1/10W, 1% 0603 SMD	Yageo
RL11	RC0603FR-07215KL	Res, 215 k $\Omega$ , 1/10W, 1% 0603 SMD	Yageo
RSET0	RC0603FR-073K24L	Res, 3.24 k $\Omega$ , 1/10W, 1% 0603 SMD	Yageo
RSET1	RC0603FR-071K6L	Res, 1.6 k $\Omega$ , 1/10W, 1% 0603 SMD	Yageo
RTERM	RC0603FR-0713K3L	Res, 13.3 k $\Omega$ , 1/10W, 1% 0603 SMD	Yageo
D1	0805KRCT	Red LED 0805	HB



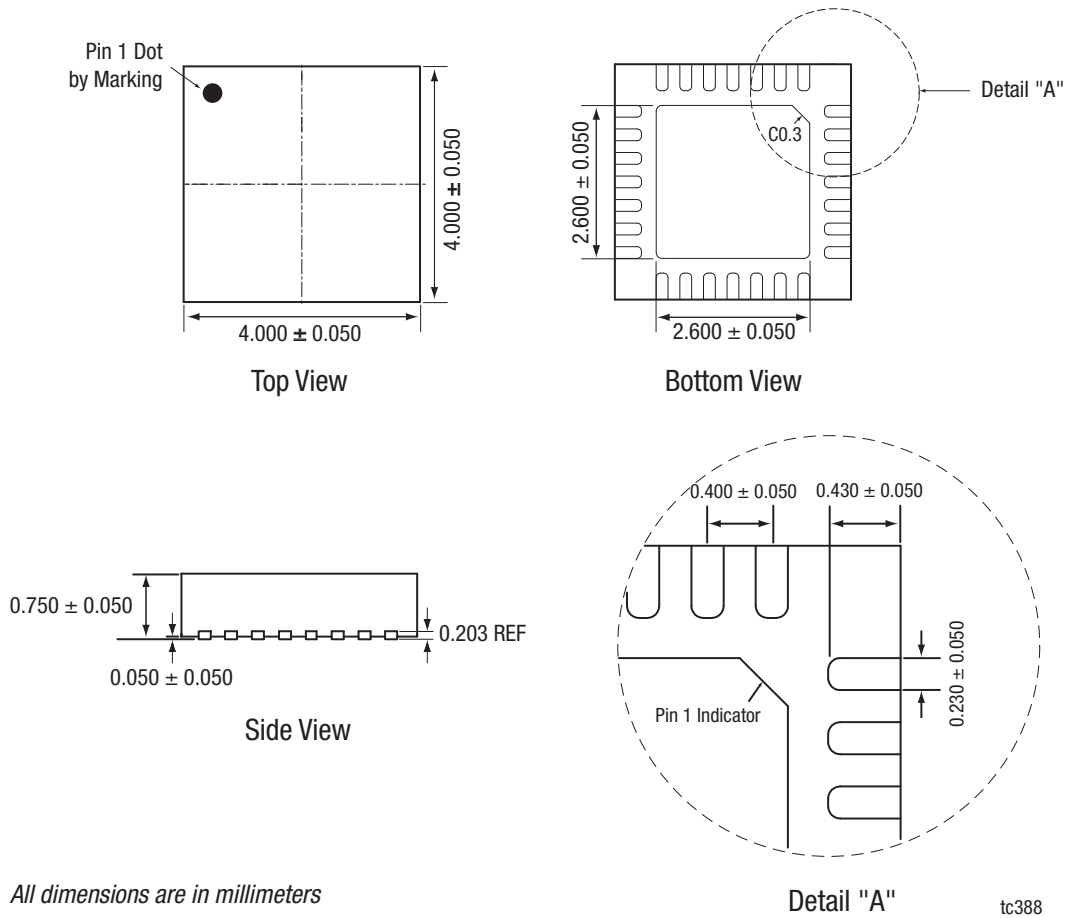


Figure 50. AAT3607 28-Pin, 4 mm × 4 mm TQFN Package Dimensions

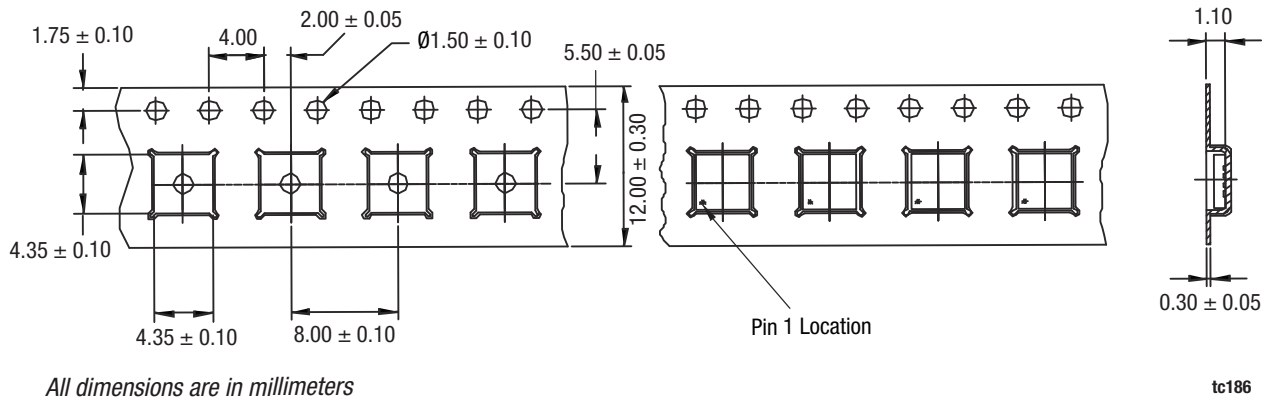


Figure 51. AAT3607 Tape and Reel Dimensions

## Ordering Information

Model Name	Part Marking (Note 1)	Manufacturing Part Number	Evaluation Board Part Number
AAT3607: PMU with OVP Dynamic Li-ion Charger	C1XY	AAT3607INJ-T1	AAT3607INJ-EVB

**Note 1:** XY = assembly and date code.

Copyright © 2012 - 2014 Skyworks Solutions, Inc. All Rights Reserved.

Information in this document is provided in connection with Skyworks Solutions, Inc. ("Skyworks") products or services. These materials, including the information contained herein, are provided by Skyworks as a service to its customers and may be used for informational purposes only by the customer. Skyworks assumes no responsibility for errors or omissions in these materials or the information contained herein. Skyworks may change its documentation, products, services, specifications or product descriptions at any time, without notice. Skyworks makes no commitment to update the materials or information and shall have no responsibility whatsoever for conflicts, incompatibilities, or other difficulties arising from any future changes.

No license, whether express, implied, by estoppel or otherwise, is granted to any intellectual property rights by this document. Skyworks assumes no liability for any materials, products or information provided hereunder, including the sale, distribution, reproduction or use of Skyworks products, information or materials, except as may be provided in Skyworks Terms and Conditions of Sale.

THE MATERIALS, PRODUCTS AND INFORMATION ARE PROVIDED "AS IS" WITHOUT WARRANTY OF ANY KIND, WHETHER EXPRESS, IMPLIED, STATUTORY, OR OTHERWISE, INCLUDING FITNESS FOR A PARTICULAR PURPOSE OR USE, MERCHANTABILITY, PERFORMANCE, QUALITY OR NON-INFRINGEMENT OF ANY INTELLECTUAL PROPERTY RIGHT; ALL SUCH WARRANTIES ARE HEREBY EXPRESSLY DISCLAIMED. SKYWORKS DOES NOT WARRANT THE ACCURACY OR COMPLETENESS OF THE INFORMATION, TEXT, GRAPHICS OR OTHER ITEMS CONTAINED WITHIN THESE MATERIALS. SKYWORKS SHALL NOT BE LIABLE FOR ANY DAMAGES, INCLUDING BUT NOT LIMITED TO ANY SPECIAL, INDIRECT, INCIDENTAL, STATUTORY, OR CONSEQUENTIAL DAMAGES, INCLUDING WITHOUT LIMITATION, LOST REVENUES OR LOST PROFITS THAT MAY RESULT FROM THE USE OF THE MATERIALS OR INFORMATION, WHETHER OR NOT THE RECIPIENT OF MATERIALS HAS BEEN ADVISED OF THE POSSIBILITY OF SUCH DAMAGE.

Skyworks products are not intended for use in medical, lifesaving or life-sustaining applications, or other equipment in which the failure of the Skyworks products could lead to personal injury, death, physical or environmental damage. Skyworks customers using or selling Skyworks products for use in such applications do so at their own risk and agree to fully indemnify Skyworks for any damages resulting from such improper use or sale.

Customers are responsible for their products and applications using Skyworks products, which may deviate from published specifications as a result of design defects, errors, or operation of products outside of published parameters or design specifications. Customers should include design and operating safeguards to minimize these and other risks. Skyworks assumes no liability for applications assistance, customer product design, or damage to any equipment resulting from the use of Skyworks products outside of stated published specifications or parameters.

Skyworks and the Skyworks symbol are trademarks or registered trademarks of Skyworks Solutions, Inc., in the United States and other countries. Third-party brands and names are for identification purposes only, and are the property of their respective owners. Additional information, including relevant terms and conditions, posted at [www.skyworksinc.com](http://www.skyworksinc.com), are incorporated by reference.