



Aurea GUI User's Guide

Aurea Graphical User Interface User's Guide

Preface

Introduction

This document provides a guide to the use of the Aurea tool with Microchip Gesture ICs.

Recommended Reading

For the latest information on using the device, read the “`Readme.html`” file (an HTML file) in the Aurea installation directory. The release notes (Readme) contains update information and known issues that may not be included in this user’s guide.

This user’s guide describes how to use the Aurea Graphical User Interface. Other useful documents are listed below. The following Microchip documents are available and recommended as supplemental reference resources.

- “*MGC3140 3D Gesture Controller Data Sheet*” (DS40002037) – Consult this document for information regarding the MGC3140 3D Gesture Controller.
- “*GestIC[®] Design Guide*” (DS40001716) – This document describes the GestIC system characteristic parameters and the design process. It enables the user to generate a good electrode design and to parameterize the full GestIC system.
- “*MGC3140 GestIC[®] Library Interface Description User’s Guide*” (DS40001875) – This document is the interface description of the MGC3140’s GestIC Library. It outlines the function of the Library’s message interface and contains the complete message reference to control and operate the MGC3140 system.

Description

The Aurea evaluation software demonstrates Microchip’s GestIC[®] technology and its features and applications. Aurea provides visualization of MGC3XX0 generated data and access to GestIC Library controls and configuration parameters. It provides the following:

- Visualization of hand position and user gestures
- Visualization of sensor data
- Run-Time Control of sensor features
- MGC3XX0 GestIC Library update
- Analog Front-End parameterization
- Colibri Signal Processing parameterization
- Logging of sensor values and storage in a log file

Software License Information

Copyright (C) 2013 Microchip Technology Inc. and its subsidiaries (“Microchip”). All rights reserved.

Aurea GUI User's Guide

You are permitted to use the Aurea software, MGC3140 Software Development Kit and other accompanying software with Microchip products. Refer to the license agreement accompanying this software, if any, for additional info regarding your rights and obligations.

SOFTWARE AND DOCUMENTATION ARE PROVIDED "AS IS" WITHOUT WARRANTY OF ANY KIND, EITHER EXPRESS OR IMPLIED, INCLUDING WITHOUT LIMITATION, ANY WARRANTY OF MERCHANTABILITY, TITLE, NON-INFRINGEMENT AND FITNESS FOR A PARTICULAR PURPOSE. IN NO EVENT SHALL MICROCHIP, SMSC, OR ITS LICENSORS BE LIABLE OR OBLIGATED UNDER CONTRACT, NEGLIGENCE, STRICT LIABILITY, CONTRIBUTION, BREACH OF WARRANTY, OR OTHER LEGAL EQUITABLE THEORY FOR ANY DIRECT OR INDIRECT DAMAGES OR EXPENSES INCLUDING BUT NOT LIMITED TO ANY INCIDENTAL, SPECIAL, INDIRECT OR CONSEQUENTIAL DAMAGES, OR OTHER SIMILAR COSTS.

Table of Contents

Preface.....	1
Description.....	1
Software License Information.....	1
1. Overview.....	4
1.1. Aurea Installation.....	4
1.2. Running Aurea.....	4
1.3. MGC3x30 and MGC3140 differences.....	4
1.4. Aurea Graphical User Interface.....	5
2. Aurea Tabs.....	8
2.1. Colibri Suite Tab.....	8
2.2. Signals Visualization Tab.....	15
2.3. Setup Tab.....	18
2.4. Demo Tab.....	49
3. Advanced Aurea Features.....	51
3.1. Logging Sensor Data.....	51
4. Revision History.....	54
5. Appendix A - Glossary.....	55
The Microchip Web Site.....	56
Customer Change Notification Service.....	56
Customer Support.....	56
Microchip Devices Code Protection Feature.....	56
Legal Notice.....	57
Trademarks.....	57
Quality Management System Certified by DNV.....	58
Worldwide Sales and Service.....	59

1. Overview

1.1 Aurea Installation

To install Aurea on your system:

1. Download the MGC3XX0 Aurea package from the Microchip website: <https://www.microchip.com/wwwproducts/en/MGC3140>;
2. Extract 'Aurea_v3.0.04.exe' from the zip file: 'Aurea_Software_Package_V3.0.04.exe.zip';
3. Run 'Aurea_v3.0.04.exe';
4. This will create the following directory structure and open the Aurea application Colibri Suite window shown below:

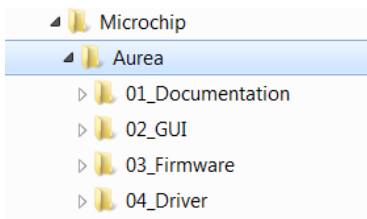

5. 'Aurea.exe' can be found in the GUI directory.

1.2 Running Aurea

Aurea requires Windows® 7, Windows® 8 or Windows® 10, operating system, a USB port and a minimum screen resolution of 1024x768.

To start Aurea:

1. Connect the GestIC device to your PC via USB port.
2. To start Aurea, double click on the 'C:\Program Files (x86)\Microchip\Aurea\02_GUI\Aurea.exe' installed on your drive after installation or select **Start > Programs > Aurea > Aurea**. A screen will display the Aurea GUI.
3. Aurea detects the GestIC device automatically and is ready for use.



Important: If you encounter problems while connecting your GestIC® device with Aurea, make sure the appropriate USB drivers are installed on your PC. For troubleshooting, refer to the user's manual of your GestIC® device.

1.3 MGC3x30 and MGC3140 differences

The MGC3X30 and MGC3140 differ in various manners. Aurea will adapt its appearance and controls to reflect those differences. This document will highlight those differences when they occur.

1.4 Aurea Graphical User Interface

Aurea's graphical user interface is divided into four sections (see [Figure 1-1](#)):

- Aurea tabs
- Run-Time Control
- Control bar
- Status bar

Figure 1-1. Aurea Graphical User Interface

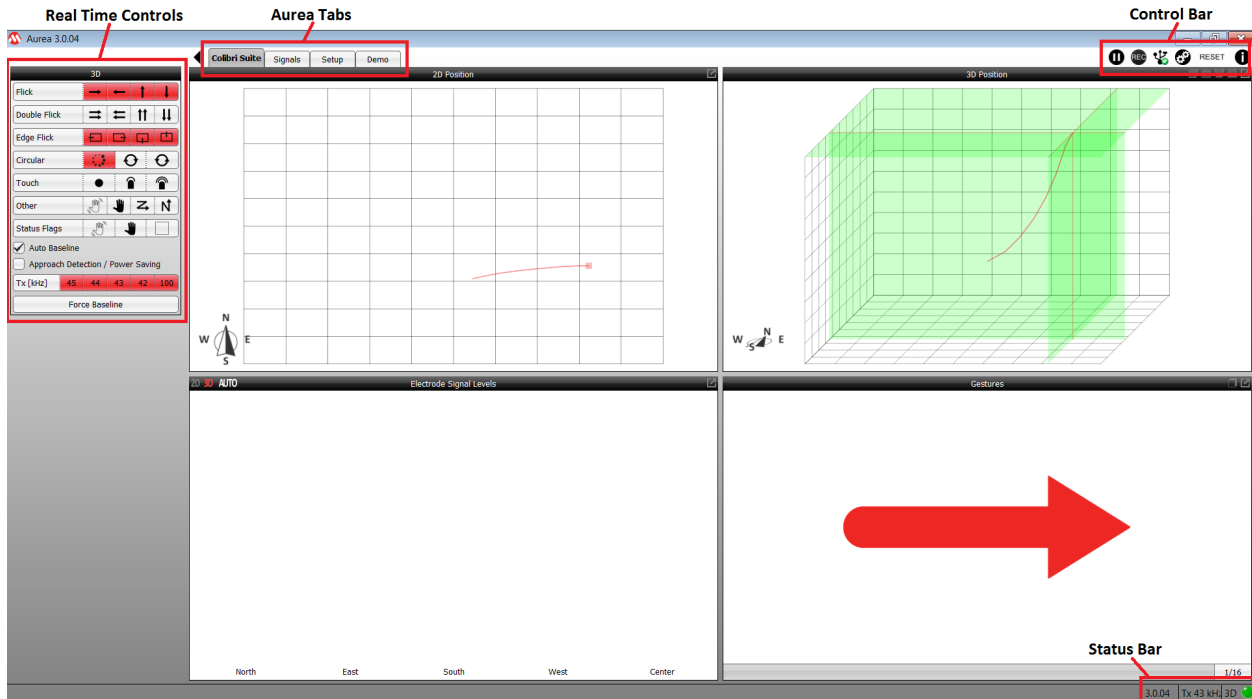

1.4.1 Aurea Tabs

The visualization of the sensor signals is shown in individual Aurea tabs, which can be selected from the upper part of the window.

- **Colibri Suite** shows the output of digital signal processing
- **Signals** plots various sensor signals over time
- **Setup** allows GestIC Library update, analog front-end (AFE) adjustments, and Colibri parameterization
- **Demo** tab provides interactive demonstrations of the MGC3XX0 3D GestIC capability

1.4.2 Run-Time Control (RTC)

Run-Time Control (RTC) can be opened and closed by clicking the arrow in the upper left corner of the Aurea window. RTC contains context-sensitive settings, which depend on the active **Aurea** tab. An example is shown in [Figure 1-2](#).

Depending on the active **Aurea** tab, context-sensitive settings can be accessed in the upper part of Run-Time Control. These settings are explained in detail in [Section 2. Aurea Tabs](#).

Figure 1-2. Aurea Run-Time Control (RTC)

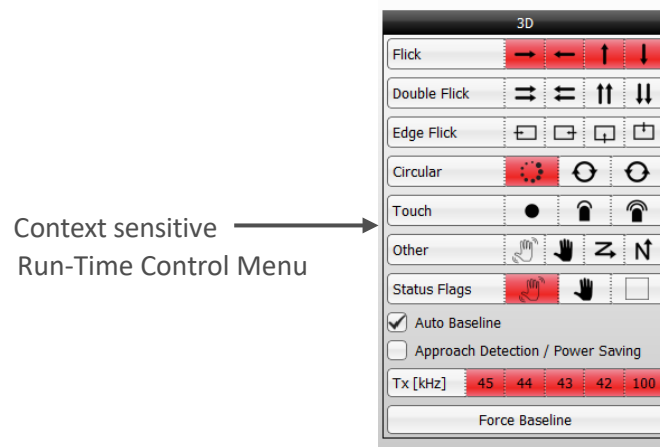

1.4.3 Control Bar

The control bar elements are valid for all Aurea tabs and are always visible across all tabs, and can be accessed in the upper right corner within the Aurea.

These static control elements are:

- **Freeze/Unfreeze Plot:**
 - Press this button to freeze the Visualization window. Press it again to continue plotting.
- **Start Log/Stop Log:**
 - Records and saves sensor data into a log file. Refer to Section 3. [Advanced Aurea Features](#) for additional details.
- **Connect/Disconnect Hardware:**
 - Toggles a connect and disconnect of the USB connection between the PC and the attached GestIC hardware.
- **Reset:**
 - Initiates a Reset of the GestIC device.
- **About Aurea:**
 - Provides details of the Aurea version, I²C bridge version, MGC3XX0 FW version, GestIC chip ID (MGC3140, MGC3130, etc).

Figure 1-3. Aurea Control Bar

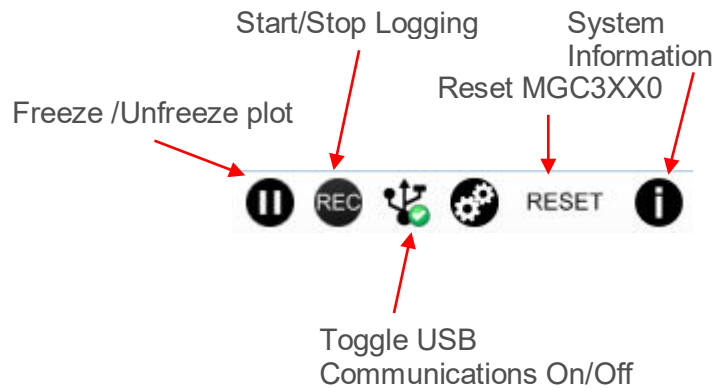

1.4.4 Status Bar

The static status bar is located at the bottom right of the Aurea window, and provides information about the recent status of the MGC3XX0 system (refer to [Figure 1-4](#)).

The following information displays from left to right:

- Colibri Suite version read from the GestIC chip after Start-up and Reset
- TX working frequency currently used
- Calibration and processing indication lights up green when the GestIC chip is in Processing mode, and turns off when in Power-Saving Sleep mode, turns blue during calibration

Figure 1-4. Aurea Status Bar

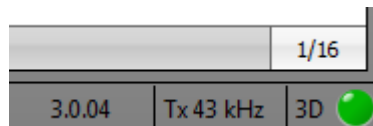

2. Aurea Tabs

This chapter describes the individual tabs of Aurea and the respective context sensitive settings within Run-Time Control.

2.1 Colibri Suite Tab

The **Colibri Suite** tab displays the MGC3XX0 3D gesture recognition and position tracking features, and is divided into four sub-windows (Figure 2-1):

- 2D XY Position Tracking Plot
- 3D XYZ Position Tracking Plot
- Signal Level Bar Graph
- Gesture Indication window/History Logging window

Note: When the Approach Detection/Power-Saving feature is enabled, the GestIC controller is set to Sleep when no hand is present and the processing indication is turned off. In addition, the signal stream stops and the tab background turns gray. When a hand approaches the sensing area, the system will wake up.

Figure 2-1. Colibri Suite Tab

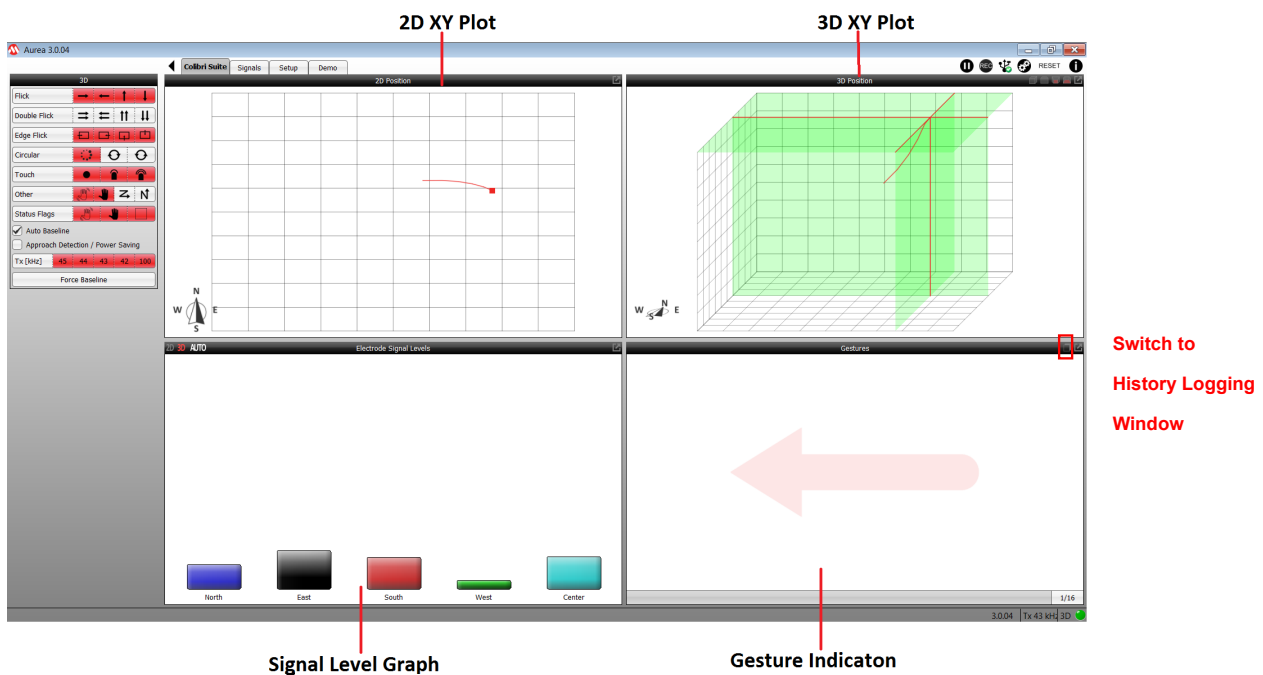

The Gesture Indication window can switch to become the History Logging window as shown below:

Figure 2-2. Gesture Window

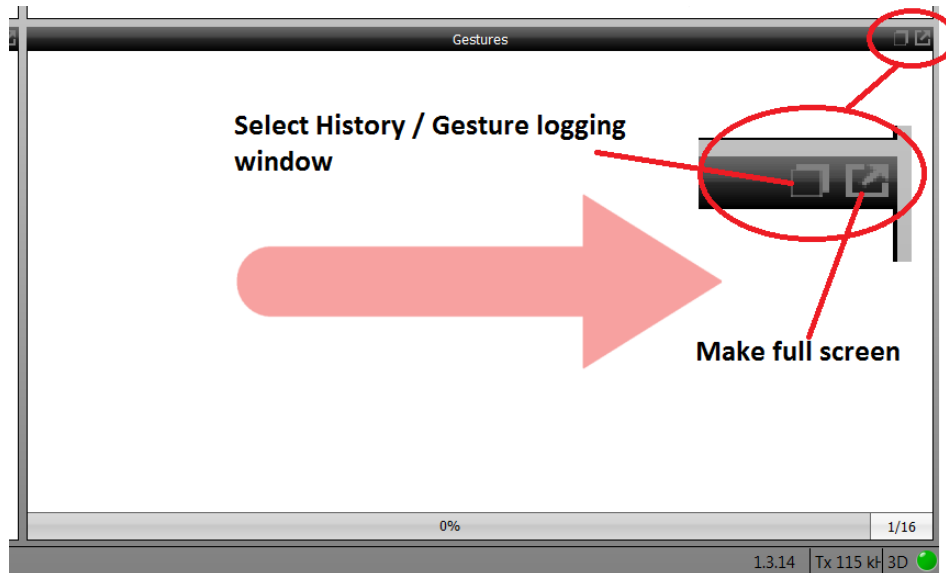
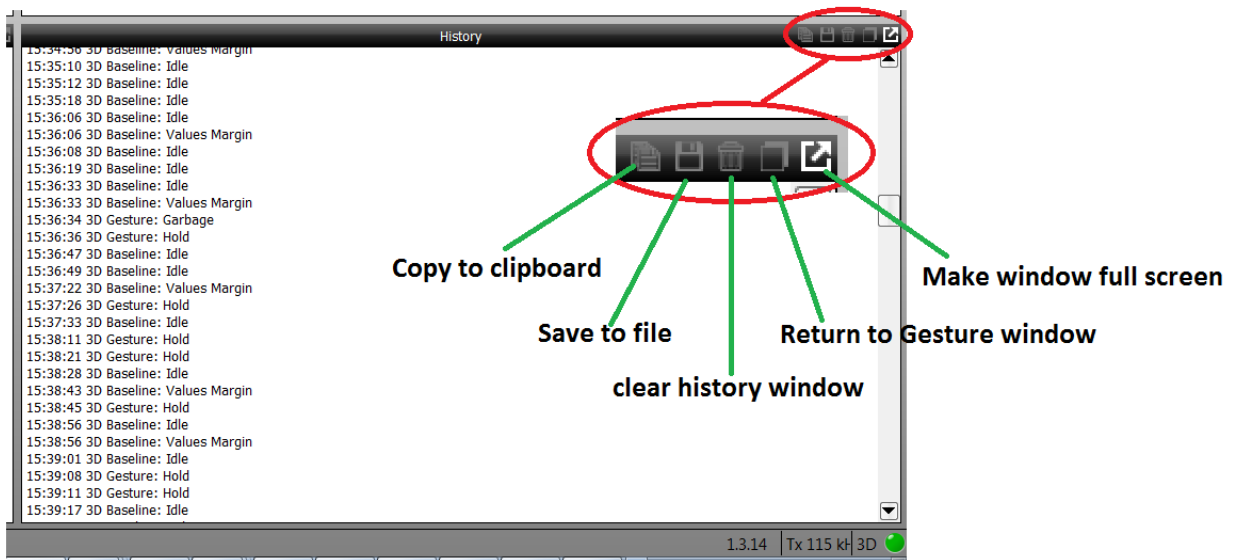

Figure 2-3. History Logging Window



2.1.1 XY and XYZ Position-Tracking Plots

The red cursor in the XY and XYZ plots appears as a projection of the user's hand position within the sensing area. The cursor follows the hand in real time, and is followed by a red tail to indicate the position history.

Figure 2-4 shows a typical set of frame electrodes and the respective sensing area in between. The origin of the coordinate system is located in the lower left corner.

Figure 2-4. Sensing Area

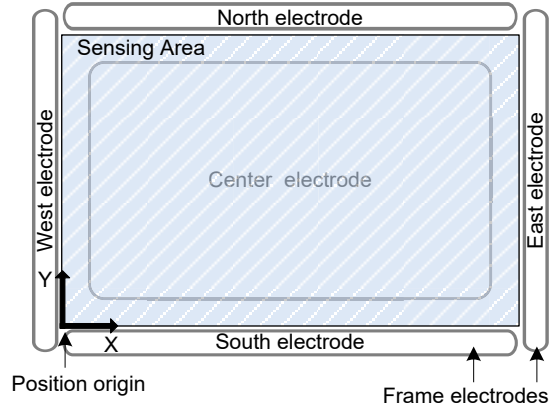

The XY plot represents the xy position of the user's hand inside the sensing area. If the user's hand is at the West side of the sensing area, the cursor appears also on the West side within the position tracking plot. Moving the hand to the East causes the cursor to follow. The XYZ plot adds the third dimension. The user can rotate the coordinate system in Aurea by using a computer mouse.

2.1.1.1 Signal Level

The sensor signals are displayed in the Signal Level bar graphic. To distinguish between the individual electrodes, they are color-coded according to their cardinal directions (North, East, South, West, Center). Approaching one electrode causes the respective signal to increase.

2.1.2 Gesture Indication

The classification of gestures is displayed in the Gesture Indication window. Refer to Section [2.1.3 Colibri Suite Run-Time Control \(RTC\)](#) for guidance on performing gestures and controlling the available gesture set.

2.1.3 Colibri Suite Run-Time Control (RTC)

The Run-Time Control (RTC) of the **Colibri Suite** tab allows the control of gestures in the Gestures section, the launch of demo applications in the Applications section and the control of selected features applied to the GestIC chip (see [Figure 2-5](#)).

Figure 2-5. Colibri Suite Run-Time Control (RTC)

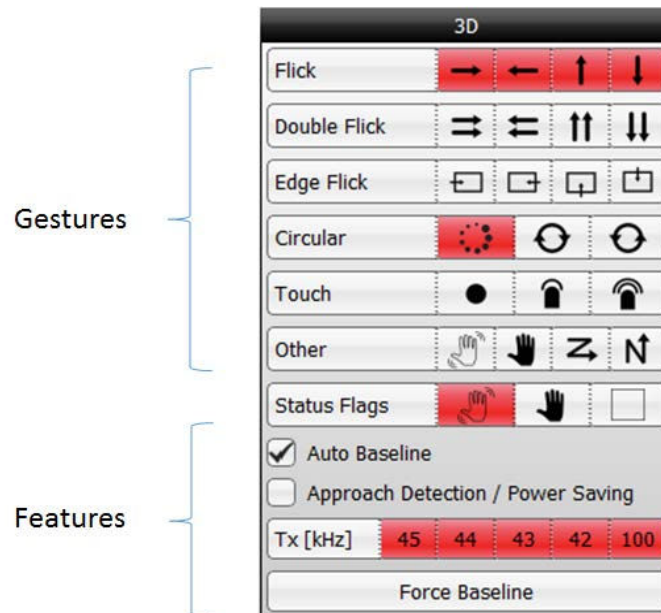

2.1.3.1 Gestures

The Colibri Suite uses Hidden Markov Models (HMM) providing user-independent gesture recognition. The gesture recognition starts when a hand enters the sensing area, or when a movement is detected after a resting period. A gesture ends when a hand leaves the sensitive area or rests inside. Gestures can have various sizes and can be performed at various speeds, within limits. For instance, gesture recognition does not trigger when the movement of a gesture is very slow or particularly fast.

Note:

1. The gesture recognition software provides a garbage model to classify unintended gestures. These gestures can be identified as “garbage model” in the History Logging window.
2. Individual gestures can be enabled or disabled within RTC. Reducing the gesture set will increase the recognition rate.

2.1.3.1.1 Flick Gestures

A Flick gesture is defined as a linear hand or finger movement in a specified direction. Flick gestures can start and end inside and outside the sensing area.

The Colibri Suite supports Flick gestures in four directions and can further distinguish edge flicks. Edge flicks are performed at the edge of the sensing area. They always start outside the sensing area and cover less than 70% of it.

The implementation of flick recognition is illustrated in [Figure 2-6](#) on the example of flicks from West to East.

Figure 2-6. Examples for Flick Recognition

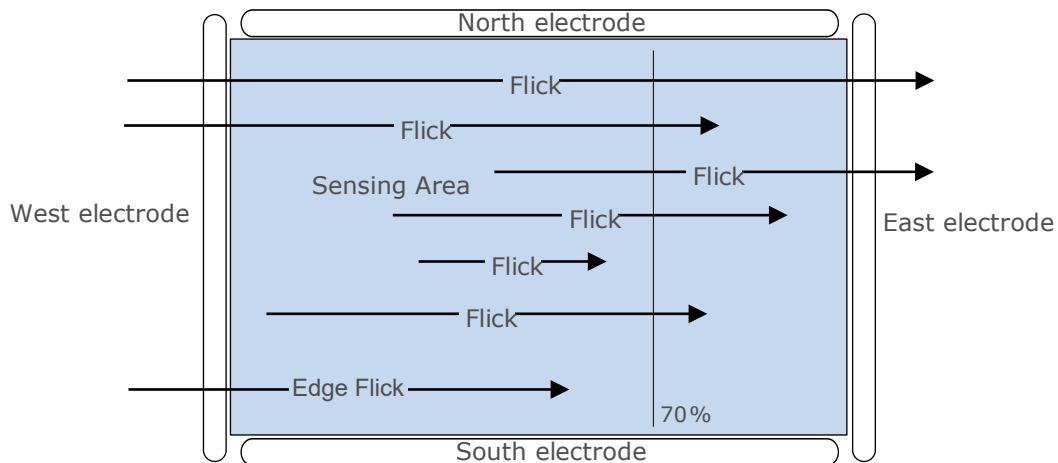

Colibri RTC supports the Flick gestures listed in [Table 2-1](#). The gestures can be individually enabled and disabled by checking and unchecking the respective check boxes.

Table 2-1. Flick Gestures

Symbol	Gesture
	Flick West to East
	Flick East to West
	Flick South to North
	Flick North to South
	Double Flick West to East
	Double Flick East to West
	Double Flick South to North
	Double Flick North to South
	Edge Flick West to East
	Edge Flick East to West
	Edge Flick South to North
	Edge Flick North to South

2.1.3.1.2 AirWheel and Circle Gestures

A Circle gesture is defined as a hand or finger movement performing a full circle. Circle gestures must be performed solely inside the sensing area and should be circular in formation. To be classified as a gesture, the user's hand must stop moving for a little while after one complete rotation or exit the sensing area.

Constantly gesturing circles without interruption will be recognized as an AirWheel gesture.



Discrete Circle gestures and AirWheel are exclusive. The AirWheel has priority over Discrete Circles. When the AirWheel is enabled then only AirWheel information will be reported. To use the Discrete Circles gestures, the application has to enable the clockwise and/or counter clockwise gestures and disable the AirWheel. Refer to Section [2.3.4 System Start-Up Window](#) page for more information.

Colibri RTC supports Circle and AirWheel gestures as listed in [Table 2-2](#). The gestures can be individually enabled and disabled by clicking on the relevant icons in the Colibri Run-Time Control window.







Important: The Circle gestures will not be recognized if the AirWheel gesture reporting is enabled.

Table 2-2. Circle and AirWheel Gestures

Symbol	Gesture
	AirWheel
	Circle clockwise
	Circle counter-clockwise

2.1.3.1.3 Touch Gestures

Touch gestures indicate if one of the four or five GestIC receive electrodes has been touched.

Symbol	Touch Gesture
	Touch to North Electrode
	Touch to South Electrode
	Touch to East Electrode
	Touch to West Electrode
	Touch to Center Electrode

.....continued	
Symbol	Touch Gesture
	Tap
	Double Tap

Touch, tap and double tap are reported in the Gestures window when enabled in the **Setup** tab. The parameters defining a tap and a double tap are configured in the Setup window.

2.1.3.2 Feature Control

2.1.3.2.1 Auto-Baseline Check Box

For the electrode system to continuously adapt to environmental changes, the GestIC Library includes an auto-baseline functionality. The baseline events can be watched in the status bar (refer to Section [1.4.4 Status Bar](#)) and the History Logging window of the **Colibri Suite** tab. Uncheck the “Auto-Baseline” check box to disable this feature.

Note:

1. When auto-baseline is disabled, baselining can be initiated manually by the **Force Baseline** button.
2. When auto-baseline is disabled, Approach Detection is also disabled.

2.1.3.2.2 Approach Detection/Power Saving Check Box

Check the “Approach Detection/Power Saving” check box to enable the Wake-up on Approach feature to save power.

Uncheck the “Approach Detection/Power Saving” check box to disable the Wake-up on Approach feature and force the system to continuously run in Processing mode.

Note: When the Approach Detection/Power Saving feature is enabled, the MGC3XX0 controller is set to Sleep when no hand is present and the processing indication is turned off. In addition, the signal stream stops and the tab background turns gray. When a hand approaches the sensing area, the system will wake up.

2.1.3.2.3 Force Baseline Button

Press **Force Baseline** to calibrate the sensor manually. Make sure the sensor is not influenced by the user when executing a baseline. The idle system is properly calibrated when the Signal Deviation of all channels is at or near zero.

2.1.3.2.4 Frequency Selection

Allows selection of any of the frequencies available for the transmitter. Typically, all five frequencies are selected to enable the GestIC chip to change frequency to avoid noise. However, if one of the frequencies clashes with a known noise source it can be disabled.

2.2 Signals Visualization Tab

The **Signals** tab plots the data streamed from the GestIC chip over time (see [Figure 2-7](#)). The unit of the signals is digits. On start-up, Aurea plots Signal Deviation data.

The user can select the following signals in RTC (refer to [Table 2-3](#)):

- Uncalibrated Signal CIC data
- Signal Deviation
- Signal Deviation Mean
- Noise Level

2.2.1 Signals Run-Time Control

When the **Signals** tab is active, Run-Time Control allows the configuration of the plot in the Signals window, and the control of selected features applied to the MGC3XX0 devices (see [Figure 2-7](#)).

Figure 2-7. Signals Run-Time Control

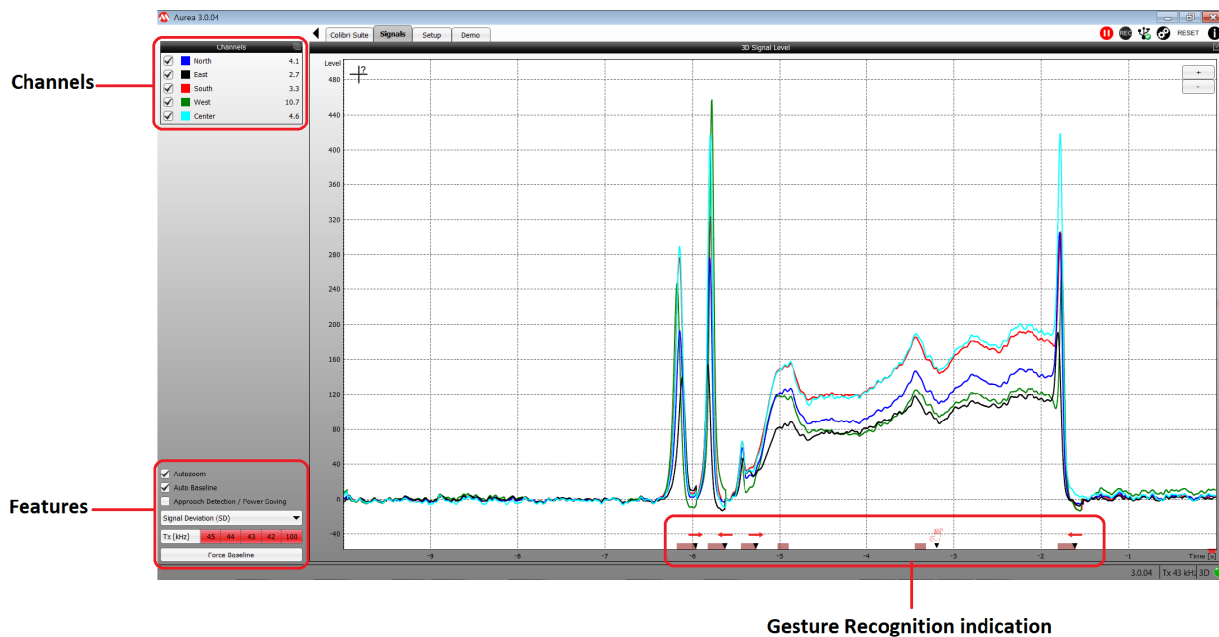

2.2.1.1 Channels

The Channels section allows the user to select the electrode signals plotted in the 3D Signal Level window. In the standard configuration, all five channels are displayed. For a detailed look into one electrode signal, unused channels can be unchecked.

2.2.1.2 Features

The Features section allows selection of:

- Autozoom
- Auto-Baseline
- Approach detection enable/disable
- Signal to display
- Frequencies enabled

- Calibration

Figure 2-8. Features

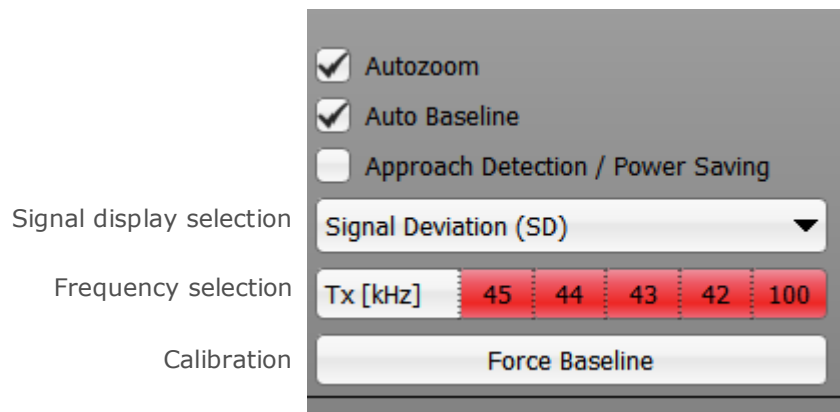

2.2.1.2.1 Autozoom Check Box

Uncheck the “Autozoom Level” check box to disable auto-scaling the y-axis in the Signals plot.

2.2.1.2.2 Auto Baseline Check Box

For the electrode system to continuously adapt to environmental changes, the GestIC Library includes an auto-baseline functionality. The baseline events can be watched in the status bar (refer to Section [1.4.4 Status Bar](#)) and the History Logging window of the **Signals** tab. Uncheck the “Auto Baseline” check box to disable this feature.

Note:

1. When auto-baseline is disabled, baselining can be initiated manually by the **Force Baseline** button.
2. When auto-baseline is disabled, Approach Detection is also disabled.

2.2.1.2.3 Approach Detection/Power Saving Check Box

Check the “Approach Detection/Power Saving” check box to enable the Wake-up on Approach feature to save power.

Uncheck the “Approach Detection/Power Saving” check box to disable the Wake-up on Approach feature and force the system to continuously run in Processing mode.

Note: When the Approach Detection/Power Saving feature is enabled, the MGC3XX0 controller is set to Sleep when no hand is present and the processing indication is turned off. In addition, the signal stream stops and the tab background turns gray. When a hand approaches the sensing area, the system will wake up.

2.2.1.3 Signal Display Selection

The signal display selection drop-down menu allows selection of the signals to display. Any one set of the signals described in the following table can be displayed.

Table 2-3. Signal Definitions

Name of Signal	Description
Uncalibrated Signal	<p>The Uncalibrated Signal (CIC) is taken directly from the decimation filter implemented in the MGC3XX0. Any other signals are calculated from there. An additional clipping indication is displayed below the Signal Level window for the MGC3X30.</p> <p>Note: MGC3140 does not feature clipping indication.</p> <p>Periodical signal peaks are observed when the automatic frequency hopping is enabled. Selecting only one frequency will avoid these peaks.</p> <p>In a third window, the signal Variance Estimate of the Colibri Suite is displayed. Automatic frequency hopping is based on this variance.</p>
Signal Deviation	<p>Signal Deviation shows the signals received from the electrodes after pre-processing and calibration. When there is no approach by a hand, the signals are approximately zero. A users approach causes the Signal Deviation to rise.</p>
Signal Deviation Mean	<p>The Signal Deviation Mean is the Signal Deviation with a simple moving average filter applied. The filtering is executed within Aurea with a filter length of 10 seconds. This signal is used when recording a sensitivity profile (refer to Section 2.3.10.5 Detection Sensitivity). A pop-up window is shown during the initialization phase. It automatically disappears when data are valid.</p>
Noise Level	<p>The Noise Level is defined as the Standard Deviation of the Uncalibrated Signal. It is calculated over 100 seconds and gives information about the self-noise level of the sensor system. A pop-up window is shown during the initialization phase. It automatically disappears when data are valid.</p>

2.2.1.4 Frequency Selection

MGCs use five transmit frequencies, with read 115, 103, 88, 67, 44 kHz for MGC3x30 and for MGC3140 ... 42 kHz, 43 kHz, 44 kHz, 45 kHz and 100 kHz. These can be individually selected or deselected to avoid known noise sources. If more than one frequency is selected, the MGC3XX0 will enter Frequency-Hopping mode, where, depending on the external noise conditions, the MGC3XX0 controller selects the best working frequency automatically. Selecting just one frequency from the list deactivates the frequency hopping.

2.2.1.5 Baseline

The **Force Baseline** button manually calibrates the sensor when selected. Care should be taken to ensure that the sensor signals are not influenced by the user presence when executing a calibration. The idle system is properly calibrated when the Signal Deviation of all channels is about zero.

2.3 Setup Tab

Selecting the **Setup** tab opens the following [window](#):

Figure 2-9. Setup Tab

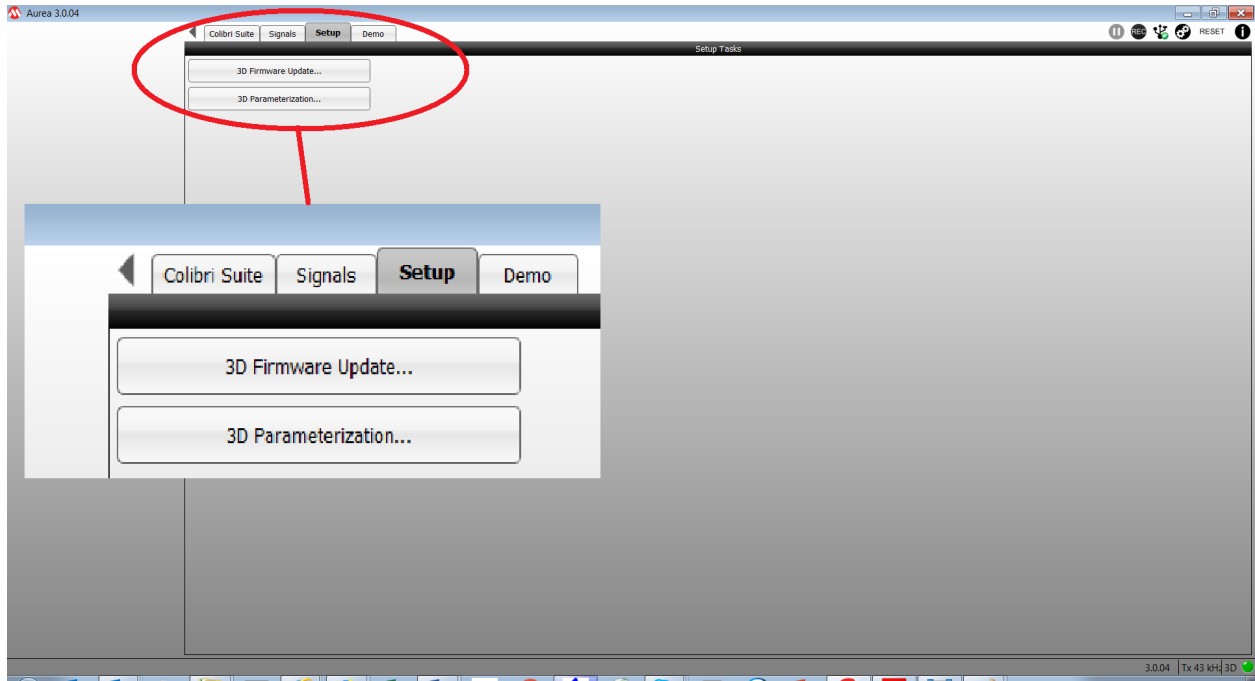

Pressing one of either the **3D Firmware Update** or **3D Parameterization** buttons will open the corresponding setup task.

Note: Under certain circumstances after parameterization the Colibri Suite windows 2D position, 3D position and electrode signal level may remain inactive and show no activity, while the Gestures window remains active and shows gestures. If this occurs, close and re-open Aurea.

2.3.1 3D Firmware Update Window

Selecting the **3D Firmware Update** button will open the following [window](#):

Figure 2-10. Firmware Update Tab

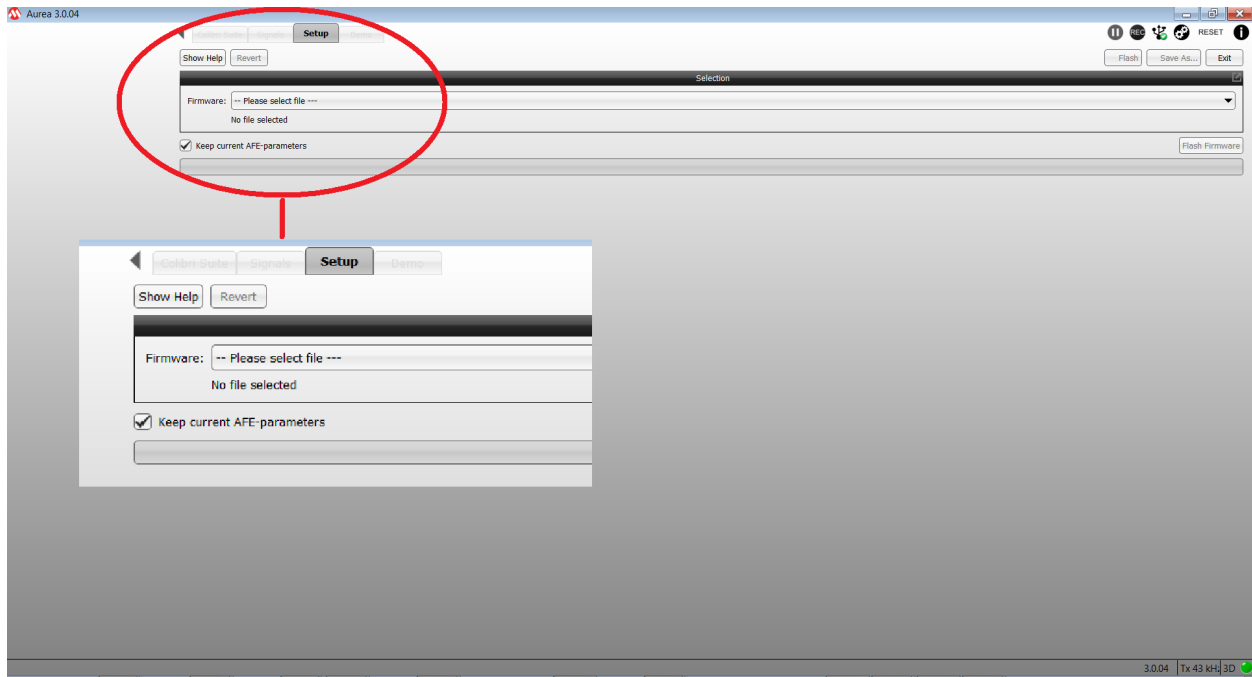

The 3D Firmware Update feature enables the user to flash a specific library file into the MGC3XX0. The library file contains a dedicated FW with a corresponding set of parameters for the dedicated target system (e.g., Emerald Development Kit with the target electrode connected to the MGC3XX0 PCB). The library file has the file ending '* .enz'. Refer to Section 2.3.12.2 [Save to new '.enz' library file](#) to create your own library file.

Note: If you do not store in Flash, settings are lost when pressing **Reset** or **Disconnect** or **Power down the Hardware**.

After selecting a library file, the progress dialogue will appear and will show the status of the Flash process. The dialogue can be closed after the successful Flash process by pressing **Exit**.

Figure 2-11. 3D Firmware Update Progress Bar

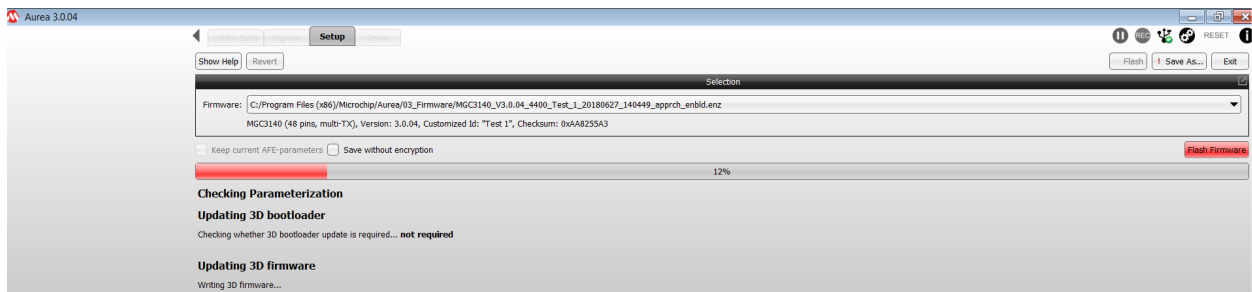

2.3.2 Setup - 3D Parameterization Window

Selection of the **3D Parametrization** button opens the parameterization window with the "Analog Front-End" (AFE) option selected to display the AFE window of [Figure 2-12](#) and [Figure 2-13](#):

Figure 2-12. MGC3140 Parameterization Window

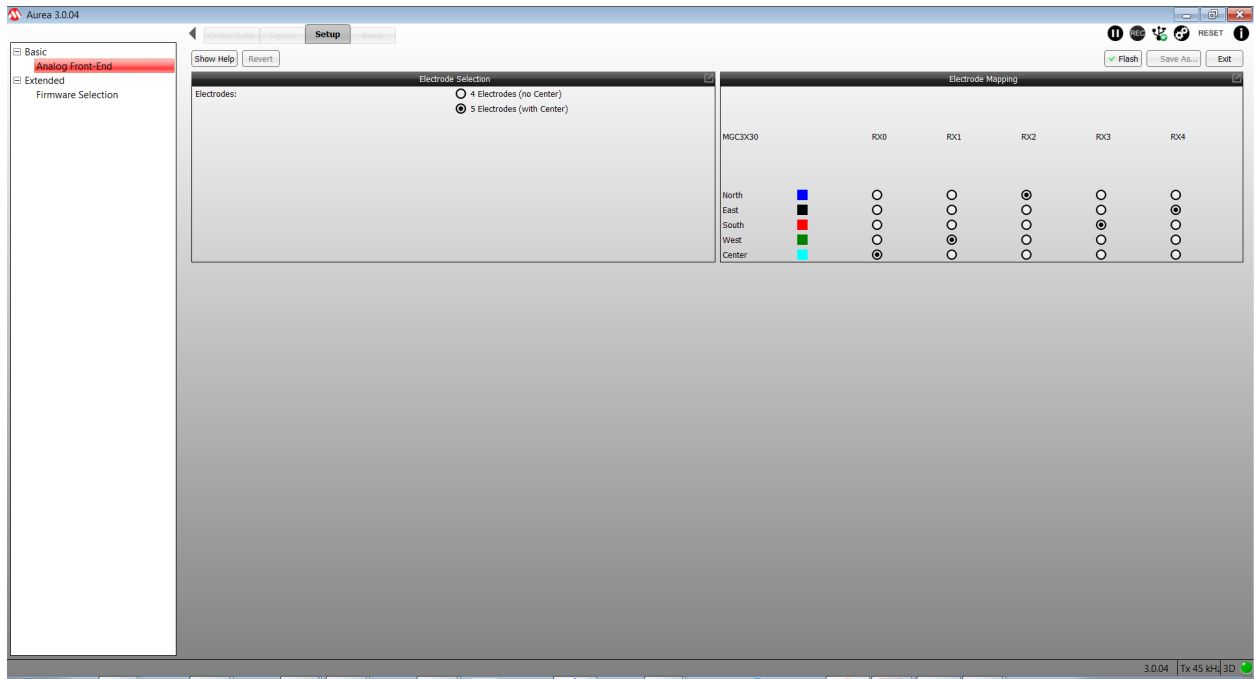
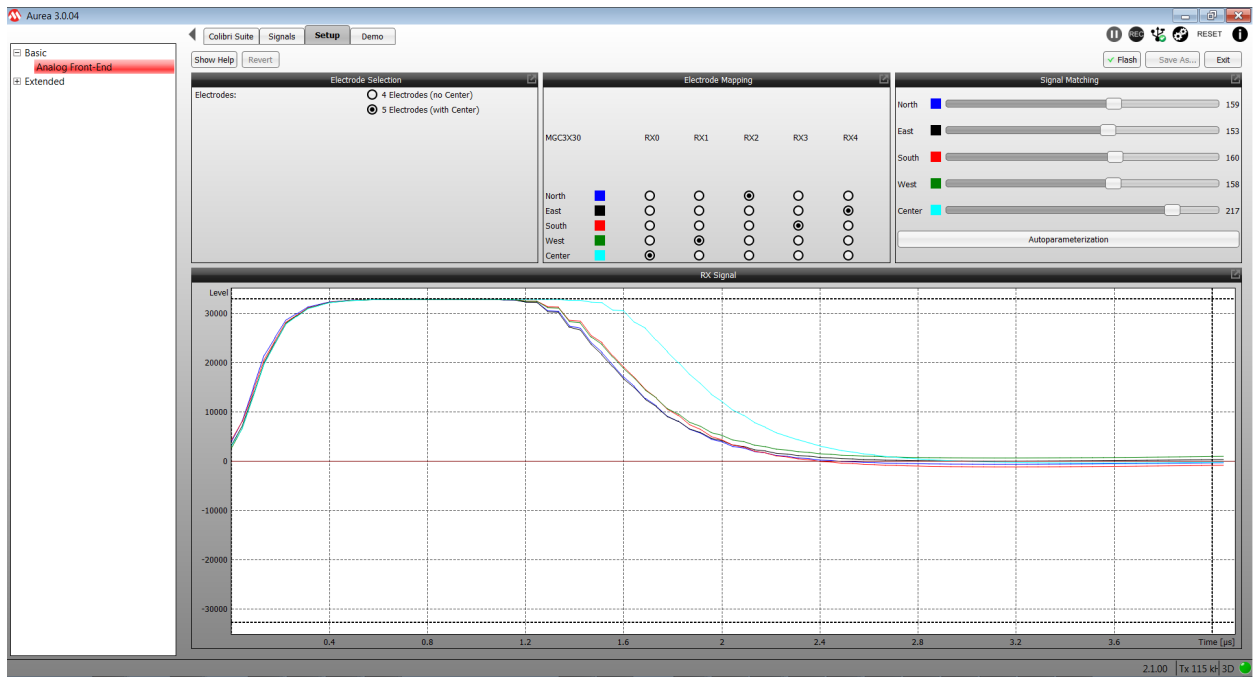

Figure 2-13. MGC3X30 Parameterization Window



The Parameterization window provides options to:

- Configure initial settings for run-time parameters
- Configure design-time parameters
- Save updated parameterization into a new '.enz' file, combining the parameterization with the FW
- Signal matching for the MGC3x30 - see Section [2.3.2.1.3 AFE Signal Matching](#)

In order to perform these actions Aurea requires the firmware and parameterization '.enz' file to be loaded onto the MGC3XX0. This ensures that parameterization is performed with the correct firmware version. It also ensures that any parameters saved are correctly combined with the FW running on the GestIC chip.

Throughout the various Parameterization windows the three buttons on the top right of the page can be used to:

- Flash parameter changes to the GestIC chip
- Save parameter changes into a new '.enz' file, combining it with the firmware entered into the Firmware Selection window (Section [2.3.3 Firmware Selection](#))
- **Exit the Setup tab:**

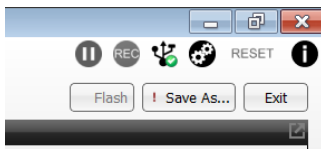

2.3.2.1 Analog Front-End Window

The **3D Parameterization** button opens the Analog Front-End (AFE) window shown in [Figure 2-12](#) for the MGC3140, and the window shown in [Figure 2-14](#) for the MGC3X30.

The MGC3140 AFE window provides Electrode Selection and Electrode Mapping functions while the MGC3x30 window provides Electrode Selection, Electrode Mapping and Signal Matching functions.

The MGC3140 AFE window differs from the MGC3X30 AFE window due to different receiver architectures. The MGC3X30 requires control of the signal matching attenuator that controls the amount of transmit signal subtracted from the received signal in order to prevent the RX signal clipping. The MGC3140 does not require this "signal matching", therefore, it does not have the Signal Matching and RX Signal windows of the MGC3X30.

2.3.2.1.1 5th Electrode Selection

The optional 5th electrode can be enabled or disabled by checking/unchecking the "5th Electrode" check box.

2.3.2.1.2 Electrode Mapping

This window allows the user to allocate the GestIC chip RX pins to the RX electrodes. The correct electrode mapping can be verified by touching the electrode and monitoring the standard deviation. This is done differently depending on whether the GestIC device is an MGC3140 or MGC3X30.

MGC3140 Electrode Mapping Verification

The correct MGC3140 electrode mapping can be verified by touching the electrode and monitoring the electrode response in either the Colibri or Signal windows.

MGC3x30 Electrode Mapping Verification

The MGC3x30 Analog Front-End window has the RX Signal Visualization window as well as the Electrode Mapping window. The correct electrode mapping can be verified by touching the electrode which will disturb the corresponding electrode signal in the Visualization window.

2.3.2.1.3 AFE Signal Matching

The analog front-end signal matching parameters are used to adjust the Rx signal level in the RX Visualization window at the sampling point to about mid-level (0) to ensure that the signals received from each electrode are similarly scaled within the chip.

These settings can be automatically configured using the **Auto-Parameterization** button or can be modified by using the respective sliders. For fine-tuning using the slider, click on the **slider** and use the arrow keys on your PC keyboard.

When selecting the AFE signal matching task, the RX signal is shown in the RX Visualization window during the first half period of the TX transmit signal. The TX transmit signal is a square wave signal. The unit is digits.

The signal plot allows the user to evaluate the quality of the analog sensor signal. An optimal signal shows an overswing or underswing up to 32,768 in the beginning and tends towards 0 at the sampling point. The overswing or underswing are determined by the capacitances of the connected electrodes (refer to "*GestIC® Design Guide*" (DS40001716) for more details). The RTC provides parameters for signal matching.

Figure 2-14. MGC3X30 AFE Window

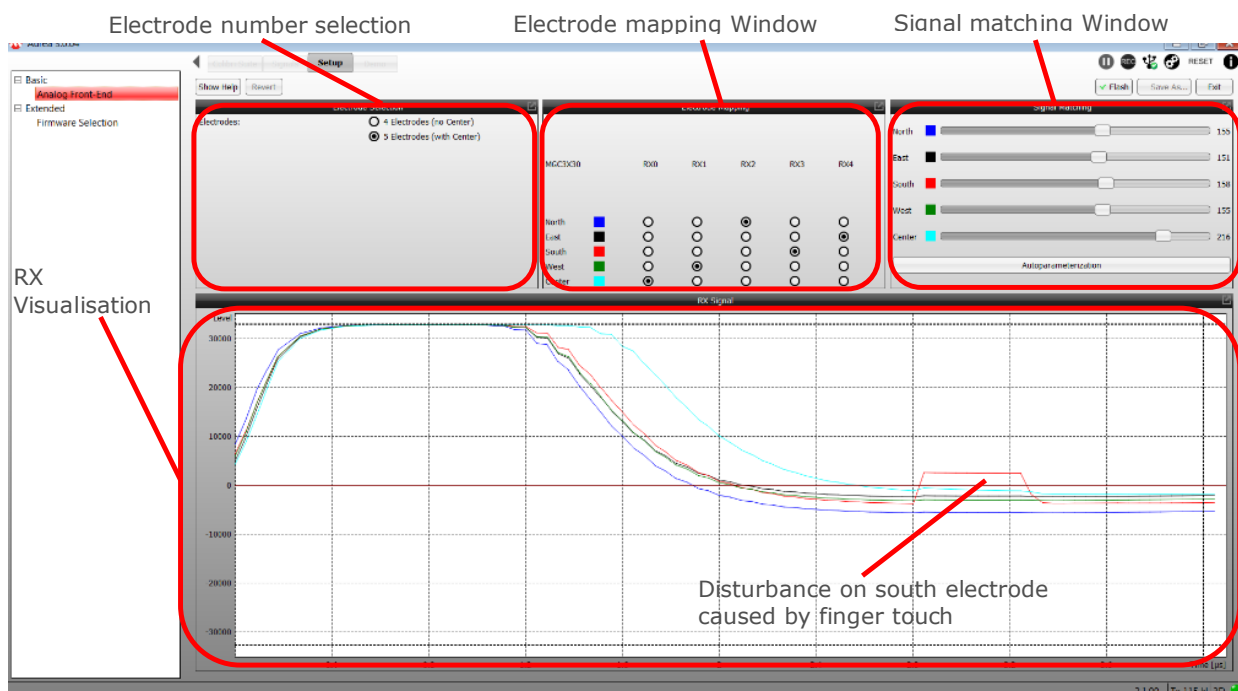

1. Decrease the Signal Matching parameters to lower the signal.
2. Press **Auto-Parameterization** to automatically signal-match all electrodes executed by Aurea.

2.3.3 Firmware Selection

When the **Extended > Firmware Selection** menu item is selected, the extended menu item opens up the [Firmware Selection](#) window. The use of this window ensures that the correct firmware is loaded onto the MGC3140 for the design-time parameterization process.

Figure 2-15. Firmware Selection Window

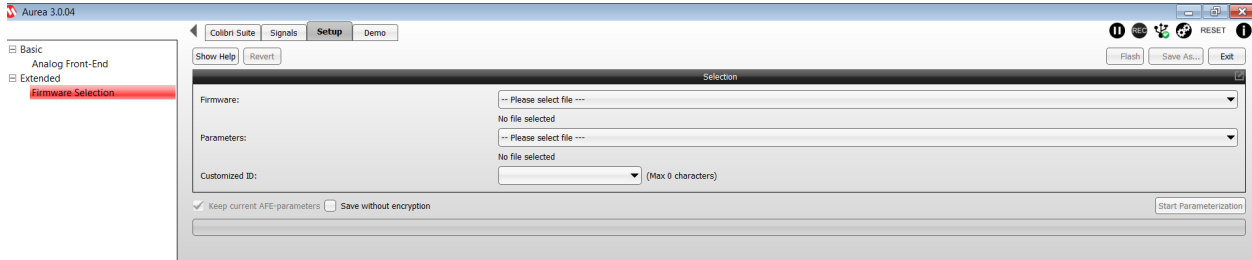

Select the firmware to load into the GestIC chip.

The parameter file option will automatically use the same file into the parameters selection box and use the parameters from that file. If required, a different, but bootloader-compatible FW file may be used in the parameters section to use different parameters. According to your needs you may specify a Customized ID of up to 16 characters. This ID will be part of the FW version information (cf. GestIC Library Interface Description guides).

Before starting the parameterization by selecting the **Start Parameterization** button, ensure the “Keep Current AFE Parameters” box is checked. This will ensure that the parameters set up in the AFE window are retained and not overwritten by those in the parameters file.

On selection of the **Start Parameterization** button the firmware and parameters are downloaded onto the GestIC chip with a progress bar showing the status.

2.3.3.1 Extended Menu Options

On completion of the update, the Extended menu options are increased, as shown in [Figure 2-16](#) with the System Start-Up window displaying:

Figure 2-16. Extended Menu Options and System Start-Up Menu after Firmware Update

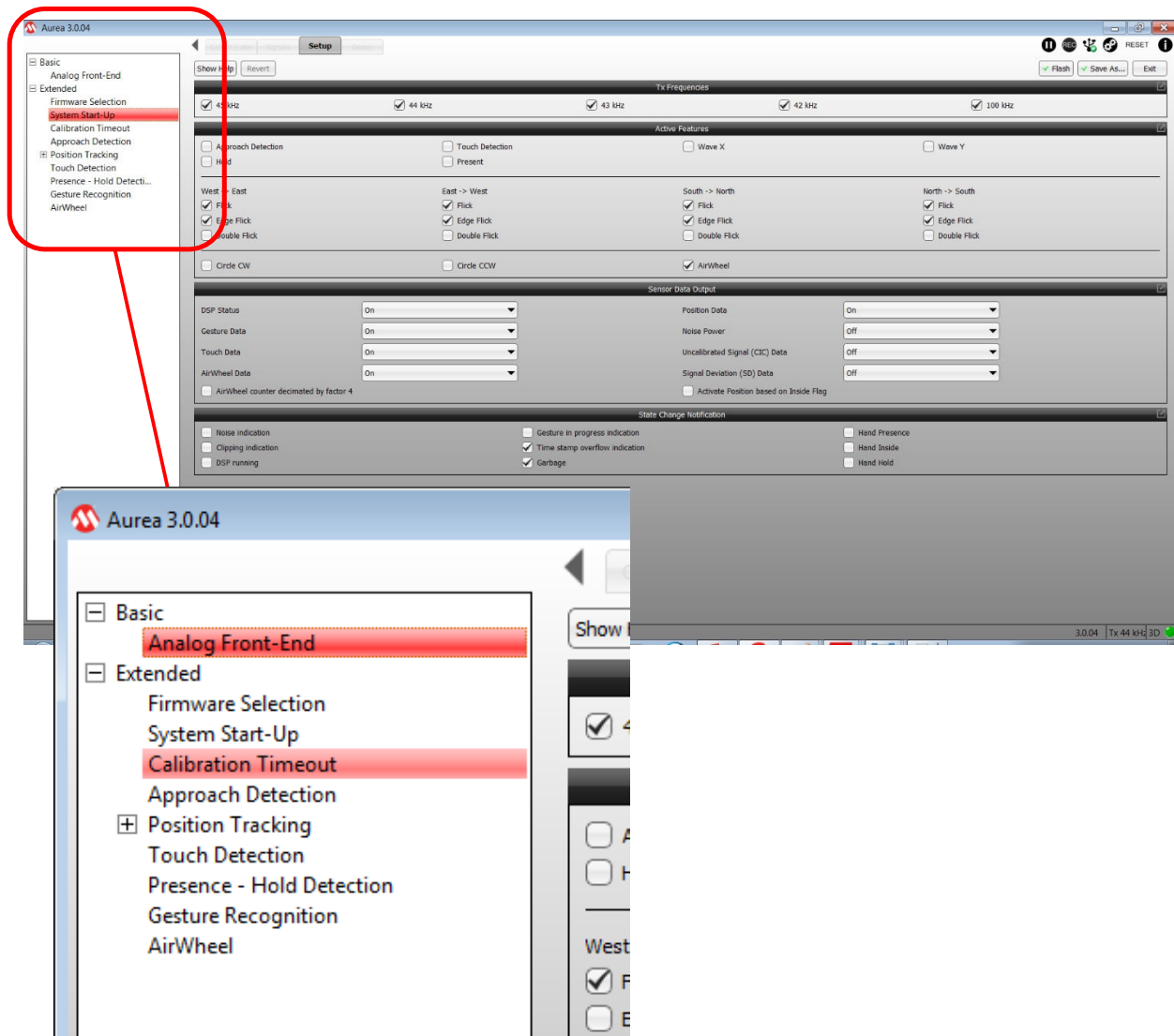

Note: Some of the options shown here may not be available for some MGC variants.

2.3.4 System Start-Up Window

This step configures the behavior of the GestIC chip on start-up. It is possible to:

- Enable or disable possible working TX Frequencies
- Select which gestures are enabled on start-up
- Configure the content of the Sensor Data Output I²C message

The settings at this page are run-time control (RTC) parameters which can be changed and saved at any time during operation.

2.3.4.1 TX Frequencies

Depending on the external noise conditions, the MGC3X30 controller selects the best working frequency automatically. The automatic frequency hopping can be limited by unchecking one or more frequencies in the list. MGC3X30 and MGC3140 have different frequencies. Furthermore, the frequencies of MGC3140 are adjustable.

2.3.4.2 Active Features

The Colibri Suite features can be set to be active or inactive on GestIC start-up:

Approach Detection to select if the **Approach Detection** feature is enabled at start-up

Touch Detection to select if the **Touch Detection** feature is enabled at start-up

Gestures selects if a particular gesture is active at start-up

Flicks Selection of flicks has the following behavior

Double Flick	Edge Flick	Flick	Description
Disabled	Disabled	Disabled	No Flick is active.
Disabled	Disabled	Enabled	Only Normal Flick reported.
Disabled	Enabled	Disabled	Only Edge Flick reported.
Disabled	Enabled	Enabled	Normal and Edge Flicks reported.
Enabled	Do Not Care	Do Not Care	Double Flick reported. Disables Normal and Edge Flicks. A Normal Flick is never reported in this instance but, if configured, it may still trigger calibrations.

Circles/AirWheel Discrete Circles and AirWheel are exclusive to each other. The AirWheel has higher priority than discrete circles. When the AirWheel is enabled, only AirWheel information will be reported. To use the discrete circle gestures, AirWheel must be disabled.

2.3.4.3 Sensor Data Output

The Sensor Data Output I²C message (ID 0x91) contains all data which are generated in MGC3X30. That includes recognized gestures as well as continuous data like position or raw sensor data.

A detailed description of the I²C message format can be found in the [“MGC3140 GestIC® Library Interface Description User's Guide”](#) (DS40001875), and the [“MGC3030/3130 GestIC® Library Interface Description User's Guide”](#) (DS40001718).

There are three options for data selection:

- Off** data will never be sent
- On** data is sent with every packet
- Dynamic** only changes will be sent to minimize data traffic

If selected (**On** or **Dynamic**), data will be added as payload element to the sensor data output I²C message.

The following table lists the payload elements of the sensor data output message:

Data/Payload Element ⁽¹⁾		Description
DSP Status	DSPStatus	This field contains the calibration events information and the currently used Tx frequency.
Gesture Data	GestureInfo	This field contains the recognized gestures.
Touch Data	TouchInfo	This field contains the Touch events information.
AirWheel Data	AirWheelInfo	This field contains the AirWheel information.
Position Data	xyzPosition	This field contains the X, Y and Z position data.
Noise Power	NoisePower	This field contains the current measured signal variance.
Uncalibrated Signal Data	CICData	This field contains the Uncalibrated Signal (CIC) data.
Signal Deviation Data	SDData	This field contains the Signal Deviation (SD) data.

AirWheel counter decimated by factor 4	If set, AirWheel counter is only reported when a change of at least 4 LSB has occurred.
--	---

Note:

1. Payload Element names are according to those in the ["MGC3X30 GestIC® Library Interface Description User's Guide"](#) (DS40001718).

2.3.4.4 State Change Notification

The sensor can also report Boolean states, some of which can be ignored to minimize the number of messages.

These Boolean states are reported as part of two payload elements: *"System Data"*, which is always present in a message and *"Gesture Data"*, that is present depending on the selection above.

The following table describes the Boolean states and to which payload element they belong:

Payload Element ⁽¹⁾	Flag	Description
SystemInfo	Noise indication	Causes a report that environmental noise has been detected.
SystemInfo	Clipping indication	Causes a report that ADC samples are clipping.
SystemInfo	DSP running	Causes a report that system is running (not sleeping).
GestureInfo	Gesture in progress indication	Causes a report that a gesture evaluation is ongoing.

.....continued		
Payload Element ⁽¹⁾	Flag	Description
GestureInfo	Garbage	De/activates the report of Garbage gesture.
GestureInfo	Hand Presence	Causes a report that object is present in sensitive region.
GestureInfo	Hand Inside	Causes a report that object is present and above the sensor.
GestureInfo	Hand Hold	The bit reports that object is present and not moving.
None	Timestamp overflow indication	De/Activates the 8-bit counter (timestamp) overflow message. This has impact on <code>TouchInfo</code> and <code>AirWheelInfo</code> messages.

Note:

1. Payload element names are according to those in the "[MGC3X30 GestIC® Library Interface Description User's Guide](#)", (DS40001718).

2.3.5 Calibration Time-Out

The Colibri Suite calibrates at regular time intervals in Self Wake-up mode, as well as in Processing mode. For Self Wake-up mode, calibration intervals are adjusted in the Approach Detection parameterization page.

For Processing mode, there are three adjustable calibration intervals, one for each of the following states:

User Absent

As long as there is no moving object in the Sensing Area and the Signal Deviation of all four frames electrodes is low (below Presence Threshold Single Threshold in Section [2.3.9 Presence and Hold Detection](#)), the user is considered to be absent.

Under these conditions, calibration will be executed in regular intervals defined by User Absent Calibration Time-out. This time-out can be adjusted between 1 and 1024 seconds, default is 2s.

User Present

If there is no moving object in the Sensing Area but the Signal Deviation of at least one frame electrode exceeds the threshold mentioned above, an object is considered to be present but not moving. This Signal Deviation can be the result of environmental changes, which should be calibrated. Under these conditions, calibration will be executed in regular intervals defined by User Present Calibration Time-out. This time-out can be adjusted in the range between 1 and 1024 seconds, default is 7s.

User Touching

A special condition of User Present is if the user is present and touching any electrode. When the user is touching, the calibration is blocked during a certain period, defined by Touch Calibration Time-out. After the blocking period, it behaves like in User Present state, which means it will calibrate after User Present Calibration Time-out. Touch Calibration Time-out can be adjusted in the range between 1 and 1024 seconds, default is 20s.

The value shown is the sum of Touch Calibration Time-out and User Present Calibration Time-out. Thus, the Touch Calibration Time-out value is changing when User Present Calibration Time-out is adjusted.

The User Absent and Present Calibration Time-outs have an impact on the Approach Detection Idle Time-out, before the system enters the Self Wake-up mode. Refer to the Approach Detection page for more information.

2.3.6 Approach Detection and Power Saving

Approach detection is used to preserve power by placing the MGC3XX0 into a lower-power Sleep mode with infrequent scans.

Utilizing the in-built Self Wake-up mode, Approach Detection alternates between Sleep and Scan phases. During the Scan phases, the approach of a human hand can be detected and will cause the MGC3XX0 to exit Sleep mode and enter Normal Run mode in order to detect gestures.

Figure 2-17. Approach Detection Sleep Window

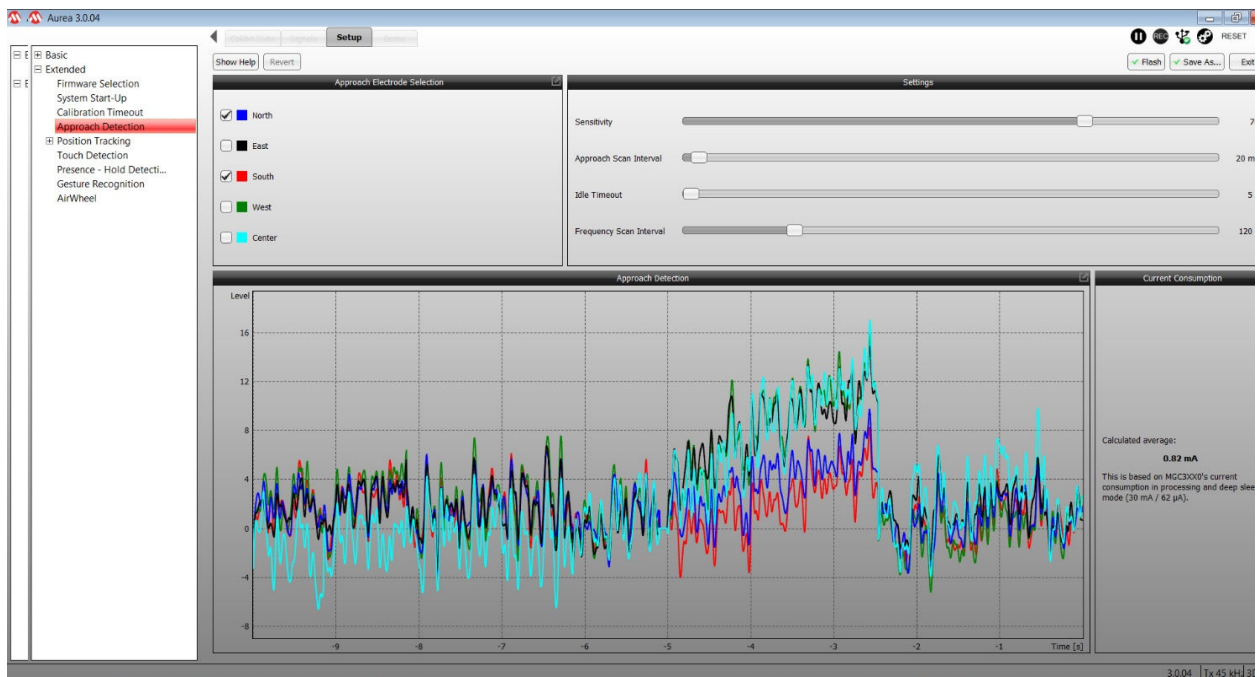

2.3.6.1 Approach Detection Modes

The MGC3XX0 has three power modes:

1. Normal Scan Processing mode – Highest current consumption
2. Approach Detection Sleep mode – Low current consumption which depends on the **approach scan interval**
3. Deep Sleep mode – controlled by GestIC library commands from the host

Within the Approach Detection sequence, the following scans are performed:

- **Approach Scan:** Approach Scans are performed during the MGC3XX0's Sleep mode. During this scan the system will check the selected RX channels, for signal changes that may indicate user activity. If activity is detected, the MGC3XX0 will autonomously wake up to Processing mode. The time interval (**Approach Scan Interval**) between two consecutive Approach Scans is configurable.
- **Frequency Scan:** Frequency Scans are performed during MGC3XX0's Sleep mode. During this scan, all electrodes are active to allow the system to adapt to environmental changes, like slow signal level drift or noise. While performing the scan, the Transmit frequency (fTx) may change if

high noise is detected. Scan duration is 200 ms per fTx. Duration of the full scan may differ, depending on how many fTx are tested/enabled. The system will test only allowed fTx and will only test the next fTx if the current one has high-noise conditions. The time interval (**Frequency Scan Interval**) between two consecutive Frequency Scans is configurable.

The timing sequence of the Approach Detection feature is illustrated in [Figure 2-18](#)

Figure 2-18. Approach Scan Timings

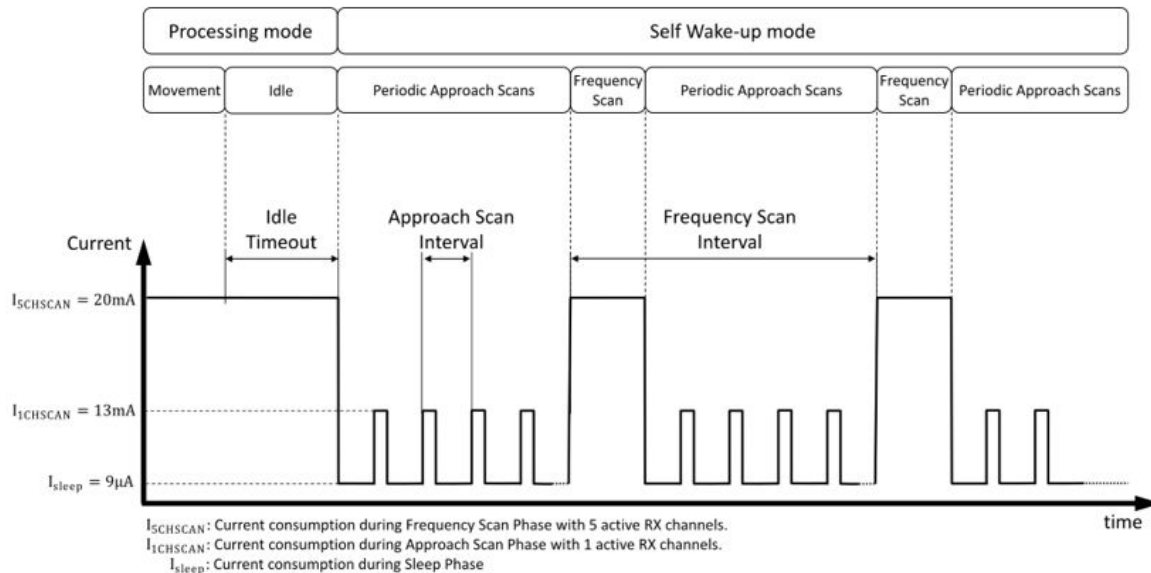

Note: The current consumption is based on the MGC3130 device.

2.3.6.2 Approach Electrode Selection

Any combination of RX electrodes can be enabled for approach detection, and the hand will be detected by just one electrode if so configured. The Approach Electrode Selection window controls which electrodes are enabled for approach detection.

A higher number of electrodes will increase the system sensitivity, but also increase the power consumption.

A lower number of selected electrodes will reduce the power consumption, but it will also reduce the active area where an approach can be detected.

2.3.6.3 Idle Time-Out

A lack of activity for a time specified by the Idle Time-out parameter will result in the MGC3XX0 entering Sleep mode. When in Sleep mode, the MGC3XX0 periodically performs a scan, looking for the presence of a hand. The interval between scans is set by the Approach Scan Interval parameter. The bigger the Approach Scan Interval the lower the power consumption, as shown by [Figure 2-18](#).

Lack of activity includes the following:

1. No hand present.
2. Hand present but unmoving as indicated by the hand-present flag in the Presence Hold Detection window.

2.3.6.4 Approach Scan Interval

This is the period on which an Approach Scan is triggered and checks for signal changes in the selected electrodes. Consequently, in the worst-case, the system will take this time period to detect activity and wake-up.

The Approach Scan Interval can be adjusted between 5 and 1000 ms, with a default of 20 ms. There is no power saving for intervals below 17 ms although the system still enters Sleep mode.

High values of the Approach Scan Interval will lead to lower current consumption but the system will be slow to detect activity and wake-up, with a worst-case wake-up delay equal to the Approach Scan Interval.

Low Approach Scan Interval values will lead to higher current consumption but the system will be faster to detect activity and wake-up.

Figure 2-19. Approach Detection Sleep Power Consumption

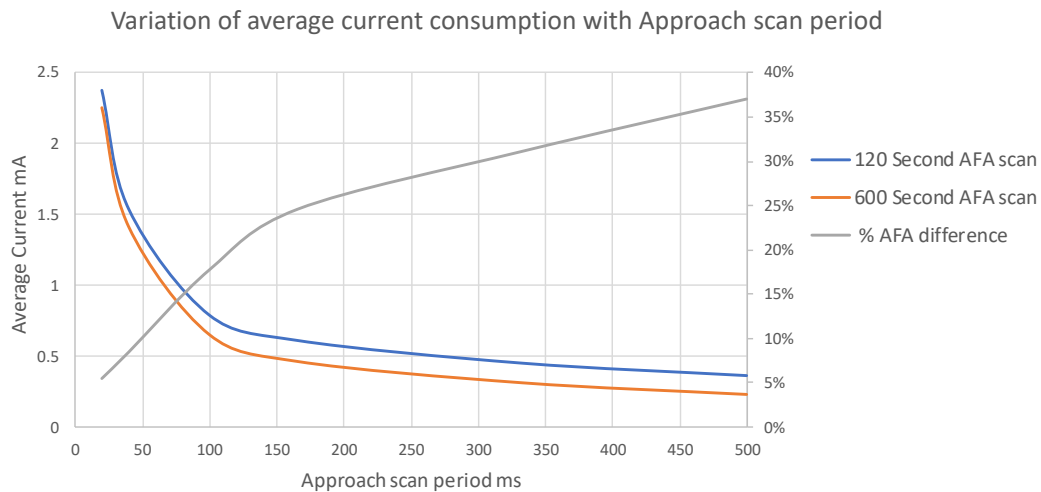

2.3.6.5 Sensitivity

The **Sensitivity** slider adjusts how much signal change is necessary to wake up the system. The value can be adjusted between 2 and 100, with a default value of 76.

High values will lead to a sensitive wake-up behavior. This means that small signal changes are enough to wake up the system. This results in higher detection range in the Self Wake-up mode, but may also lead to unintended wake-ups due to increased noise levels.

Low values will lead to a less sensitive wake-up behavior. This means that higher signal changes are necessary to wake up the system. This results in lower detection range in the Self Wake-up mode but, on the other hand, the system will be less prone to unwanted wake-ups in case of increased noise levels.

Figure 2-20 shows the variation of detection/wake-up height against sensitivity:

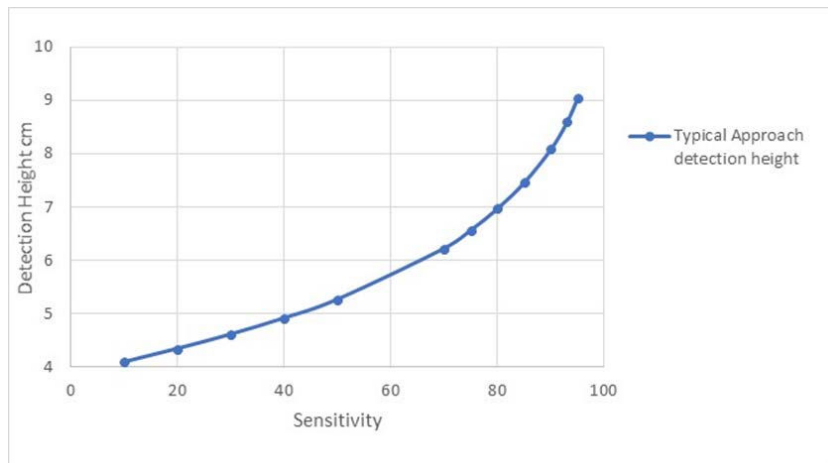
Figure 2-20. Approach Detection Height Variation with Sensitivity

Note: This is sensor-specific, different sensors will have different wake-up heights, but the slope of the graph will remain the same.

2.3.6.6 Frequency Scan Interval

During a frequency scan, all electrodes are active to allow the system to adapt to environmental changes, like slow signal-level drift or noise. While performing the scan, the Tx frequency (fTx) may change if high noise is detected. Scan duration is 200 ms per fTx. Duration of the full scan may differ, depending on how many fTx are tested.

The system will test only allowed fTx and will only test the next fTx if the current one has high-noise conditions. The time interval (Frequency Scan Interval) between two consecutive Frequency Scans is configurable.

The timing sequence of the Approach Detection feature is illustrated in [Figure 2-18](#).

2.3.7 Position Tracking

MGC's Position Tracking can be optimized by the following steps:

- Electrode Dimensions
- Electrode Weighting (optional)
- E-Field Linearization (optional)
- Sensing Area
- Minimum Z Level
- Maximum Z Level
- Filter Adjustment

2.3.7.1 Step One - Electrode Dimensions

The Electrode Dimensions step shows the information on how to measure the electrode dimensions.

Figure 2-21. Unequalized Sensing Space

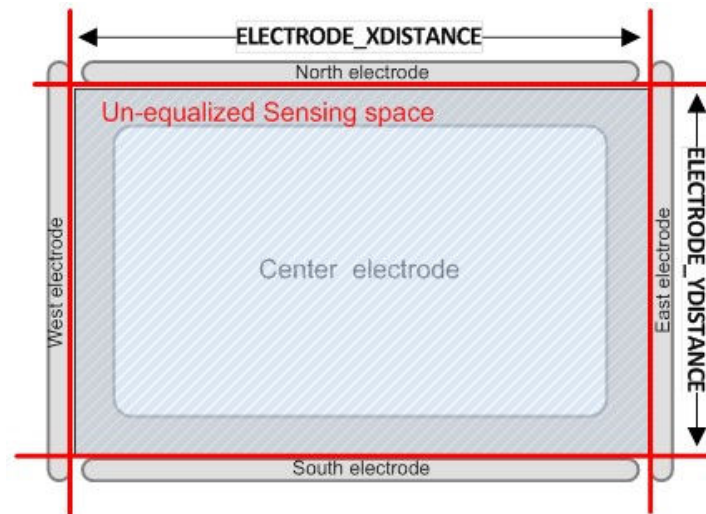

The Electrode Dimensions step covers the parameter settings 'Electrode X Distance' and 'Electrode Y Distance'. These settings can be modified by using the respective **slider**. For fine tuning, click on the **slider** and use the **arrow keys** on your PC keyboard.

Figure 2-22. Parameterization Step - Electrode Dimension

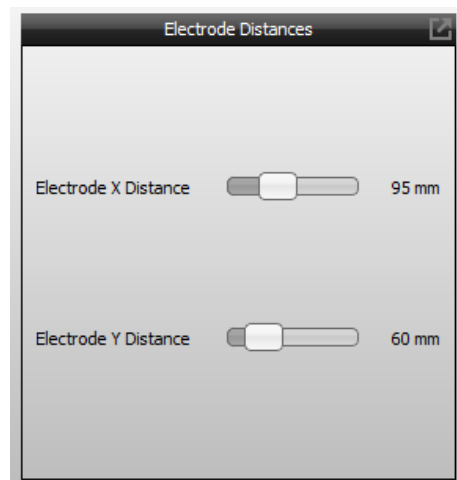

2.3.7.2 Step Two - Electrode Weighting

During the optional Electrode Weighting step, five measurements with brick and five corresponding reference measurements without a brick are conducted at a constant brick Z-level of 30 mm. The drawing in the Electrode Weighting step will show the position where to place the brick for the current measurement (West, North, East, South and Center).



Important: Use always the 30 mm Styrofoam spacer brick to establish the distance between hand brick and electrodes.

Figure 2-23. Electrode Weighting - Animation Brick Position

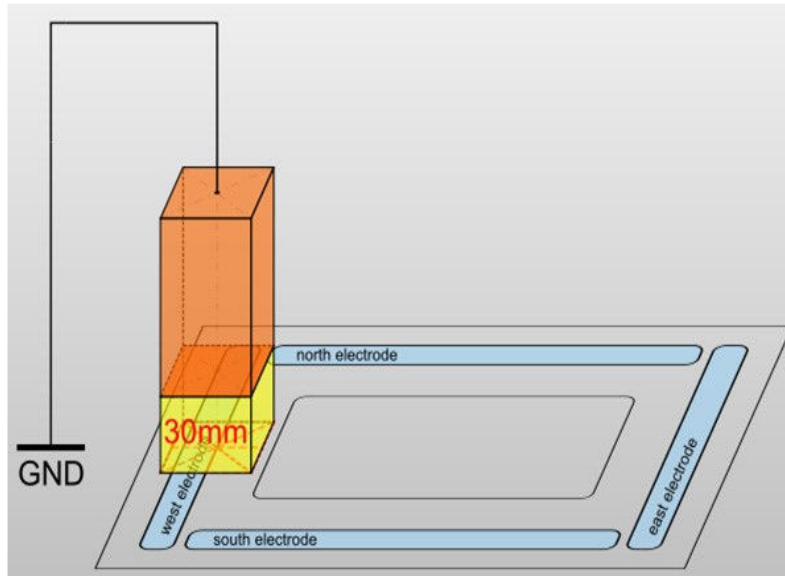

Note: It is not necessary to adjust/correct the 30 mm Styrofoam spacer brick for the thickness of the target device's housing, or for a decoration layer covering the electrodes.

The **Start Measurement** button will trigger the measurement. After pressing the button, a **progress bar** in the Visualization window will occur.

Figure 2-24. Electrode Weighting - Progress Bar

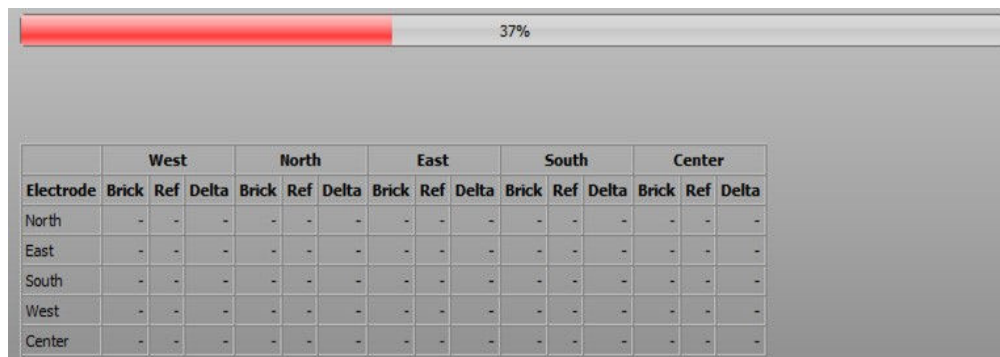

The reference needs to be measured within the next 10s to avoid influences from drifts. A down counter is displayed in the Visualization window (see [Figure 2-25](#)).

Figure 2-25. Electrode Weighting - Measurement Down Counter

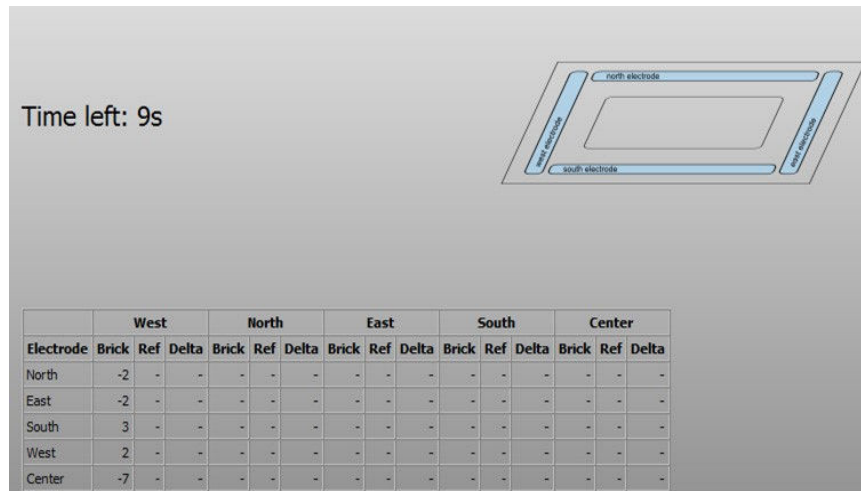

If the reference measurement was not acquired during these 10s, a pop-up window will be displayed (see [Figure 2-26](#)).

Figure 2-26. Electrode Weighting - Measurement Time Out

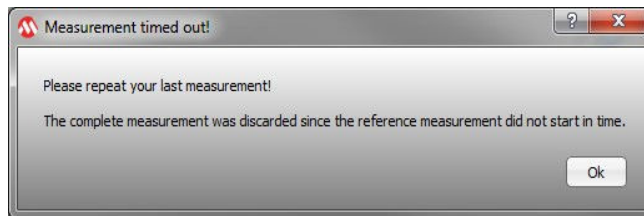

Removing the brick and pressing the **Start Measurement** button will trigger the reference measurement. A progress bar in the Visualization window will occur. The brick and reference measurements are displayed in addition to Signal Deviation (Delta) (see [Figure 2-27](#)).

Figure 2-27. Electrode Weighting - Measurement Results

	West			North			East			South			Center		
Electrode	Brick	Ref	Delta	Brick	Ref	Delta	Brick	Ref	Delta	Brick	Ref	Delta	Brick	Ref	Delta
North	136	-1	137	301	-7	308	127	-1	129	92	-9	101	253	1	252
East	30	-6	35	85	-4	89	248	-6	254	104	-6	111	164	-1	165
South	124	-1	125	81	0	81	120	-3	123	286	-8	294	276	1	275
West	270	-3	273	105	-2	108	38	-4	42	92	-5	97	149	-4	153
Center	194	-3	196	216	-5	221	190	2	188	228	-7	235	416	-4	420

The measurement process checks if the measured data are valid or not and if the environment is noisy or not. When the data are not valid, they will be displayed in red in the measurement results table. The user has to check noise sources (PC ground, hand brick is not connected to ground) and repeat the measurement.

2.3.7.3 Step Three - E-Field Linearization

During the optional E-Field Linearization step, four measurements with brick and four corresponding reference measurements without a brick are conducted at the center position of the system. The drawing in the E-Field Linearization step shows the spacer brick to be used (10 mm, 30 mm, 50 mm and 80 mm) (see [Figure 2-28](#)).



Important: Always use a Styrofoam spacer brick to establish the distance between hand brick and electrodes.

Figure 2-28. E-Field Linearization - Animation Brick Position

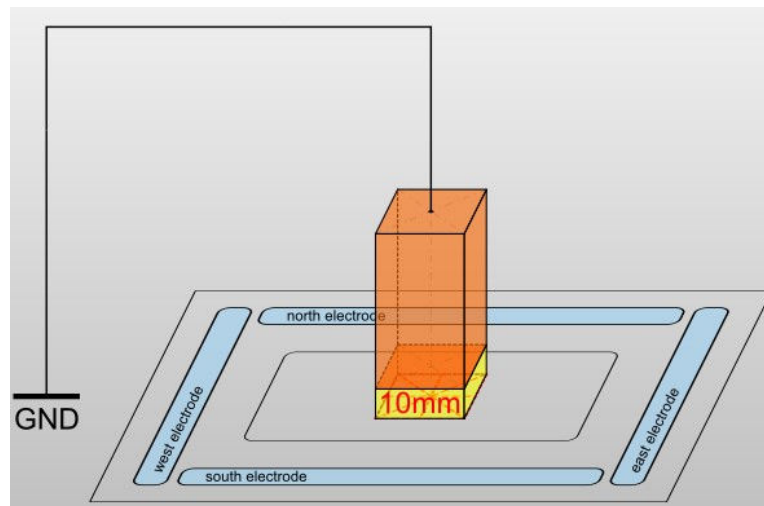

The **Start Measurement** button will trigger the measurement. After pressing the button, a [progress bar](#) in the Visualization window will occur.

Figure 2-29. E-Field Linearization - Progress Bar

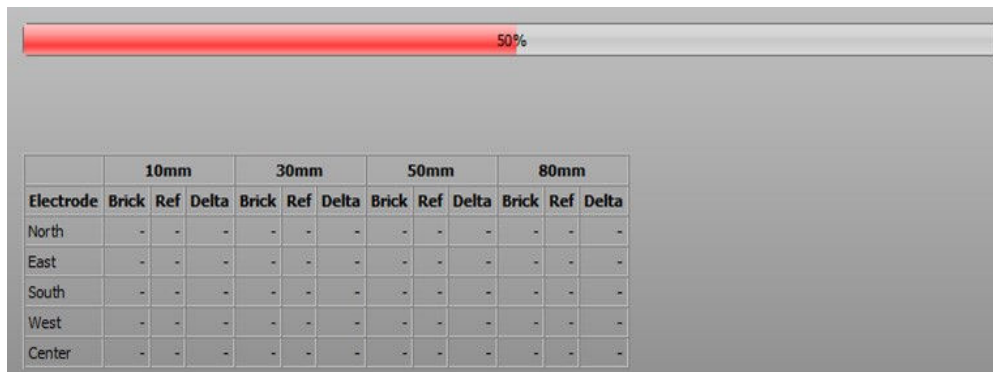

The reference needs to be measured within the next 10s to avoid influences from drifts. A down counter is displayed in the Visualization window (see [Figure 2-30](#)).

Figure 2-30. E-Field Linearization - Measurement Down Counter

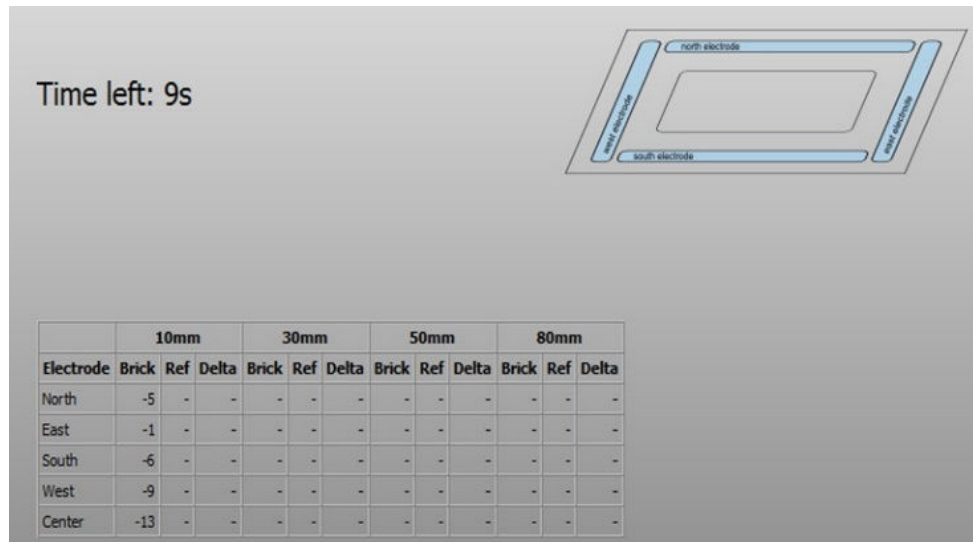

If the reference measurement was not acquired during these 10s, a pop-up window will be displayed (see [Figure 2-31](#)).

Figure 2-31. E-Field Linearization - Measurement Time-Out

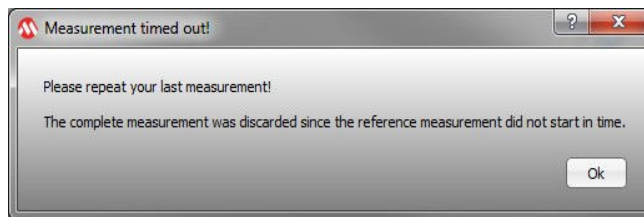

Removing the brick and pressing the **Start Measurement** button will trigger the reference measurement. A progress bar will occur in the Visualization window. The brick and reference measurements are displayed in addition to Signal Deviation (Delta) (see [Figure 2-32](#)).

Figure 2-32. E-Field Linearization - Measurement Results

	10mm			30mm			50mm			80mm		
Electrode	Brick	Ref	Delta	Brick	Ref	Delta	Brick	Ref	Delta	Brick	Ref	Delta
North	620	-1	621	223	-3	225	88	0	88	-	-	-
East	295	1	294	122	-4	126	65	0	65	-	-	-
South	614	1	613	233	0	233	89	1	88	-	-	-
West	317	2	315	160	1	160	66	1	65	-	-	-
Center	1570	0	1570	360	-2	362	113	-2	115	-	-	-

The measurement process checks if the measured data are valid or not and if the environment is noisy or not. When the data are not valid, it will be displayed in red in the measurement results table. The user has to check noise sources (PC ground, hand brick is not connected to ground) and repeat the measurement.

2.3.7.4 Step Four - Sensing Area

The Sensing Area parameterization step is intended to adapt the calculated X-Y Position to the real electrode dimensions of the system. The four scaling parameters 'X Pos Min', 'X Pos Max', 'Y Pos Min' and 'Y Pos Max' are therefore used. The grid of the 2D Position plot in the Visualization window will be scaled if a slider of these parameters is moved.

The **Apply** button will apply the current setting and will scale the calculated position. The **Clear Plot** button will reset the position drawing.

Figure 2-33. Sensing Area - Settings

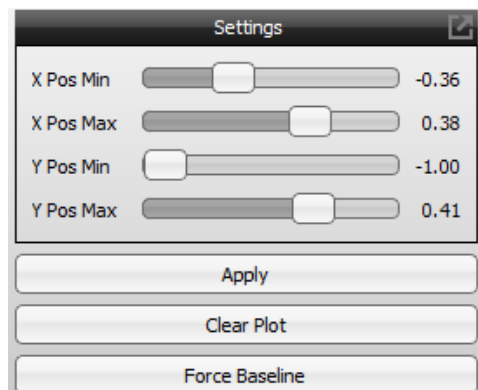

The sub-steps within the Sensing Area step are as follows:

1. While touching the device, move with the hand posture, (typical for the application), along the maximum X-Y positions which you would like to reach in your application (see [Figure 2-34](#)).
2. Repeat the hand moving along the maximum X-Y position approximately ten times to get a more meaningful drawing. The 2D-signal plot in the Visualization window draws the calculated position based on the hand movement. It is likely that the real position does not fit the calculated position.
3. Use the **slider** of the four scaling parameters to reduce the grid size until it fits within the deformed position drawing (see [Figure 2-35](#)).
4. Press **Apply** and check if it is now possible to reach all X-Y positions with the same hand movement.
5. Press **Next** if you can reach all positions. If not, press **Apply** again to leave the Live Preview mode and adjust the parameters again until the positioning meets your expectation.

Figure 2-34. Sensing Area - Hand Movement

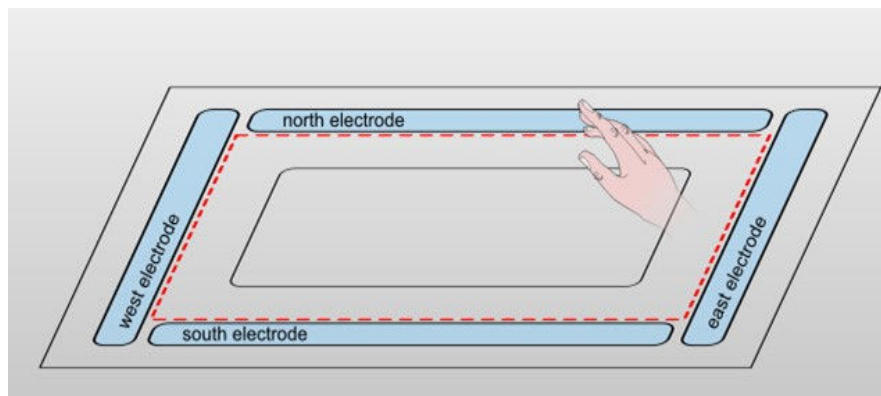
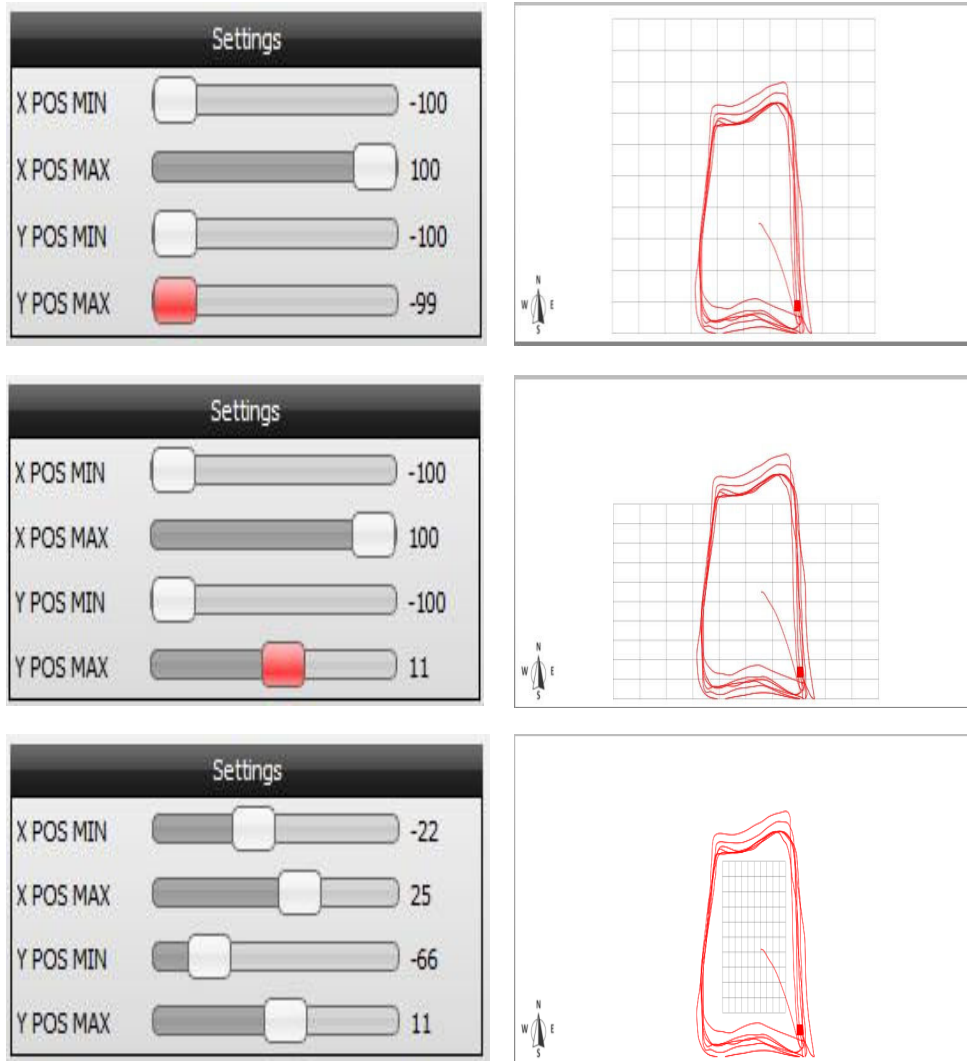

Figure 2-35 shows a typical position drawing and the parameter setting for the corresponding parameterization step. The grid and, thus, the scaling are changing with the parameter settings.

Figure 2-35. Sensing Area - Parameter Adjustment



Note: Please experiment with these settings to improve the system linearity. Typically, the smaller the grid size, the more linear the system behaves.

2.3.7.5 Step Five - Minimum Z Level

Similar to the [Sensing Area](#) step which was intended to adjust the X-Y positioning, the Z positioning step is intended to adjust the Z position calculation.

The Run-Time Control part of this step covers the parameter 'Z POS MIN'. This parameter can be modified by using the respective [slider](#). For fine tuning, click on the [slider](#) and use the **arrow keys** on your PC keyboard.

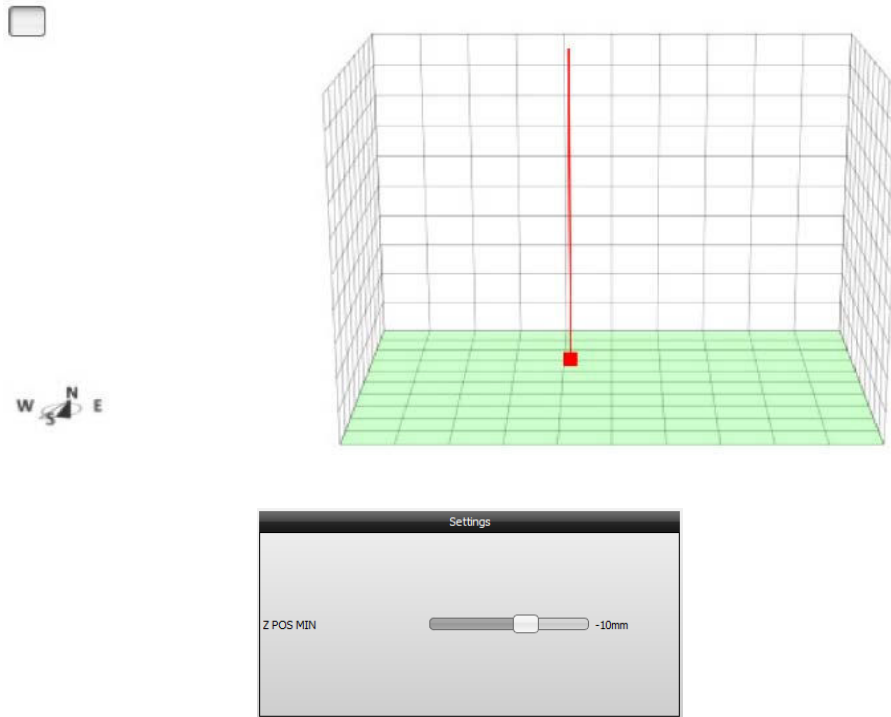
Figure 2-36. Touch Level - Parameter Adjustment

Touch the surface of the sensing area with the typical hand posture for the application and adjust the **slider** of 'Z POS MIN' until the green Z level illustrated in the 3D-signal plot in the Z Positioning window hits the *zero level*. The *zero level* in this manner is the lowest level which is possible to reach in the 3D-signal plot (see [Figure 2-36](#)). The Z position must increase when the hand is moving up from the surface.

2.3.7.6 Step Six - Maximum Z Level

The Run-Time Control part of this step covers the parameters maximum distance level. This parameter setting can be modified by using the respective **slider**. For fine tuning, click on the **slider** and use the **arrow keys** on your PC keyboard.

The maximum Z position adjustment requires an approach from the top with a typical hand posture for the application. Adjust the value of the parameter 'Z POS MAX' until the green Z-level is on the top of the grid when you leave with your hand the sensing area in the Z direction (see [Figure 2-37](#)).

Press **Apply** and check if it is now possible to reach maximum Z position with your hand.

Figure 2-37. Maximum Z Level - Parameter Adjustment

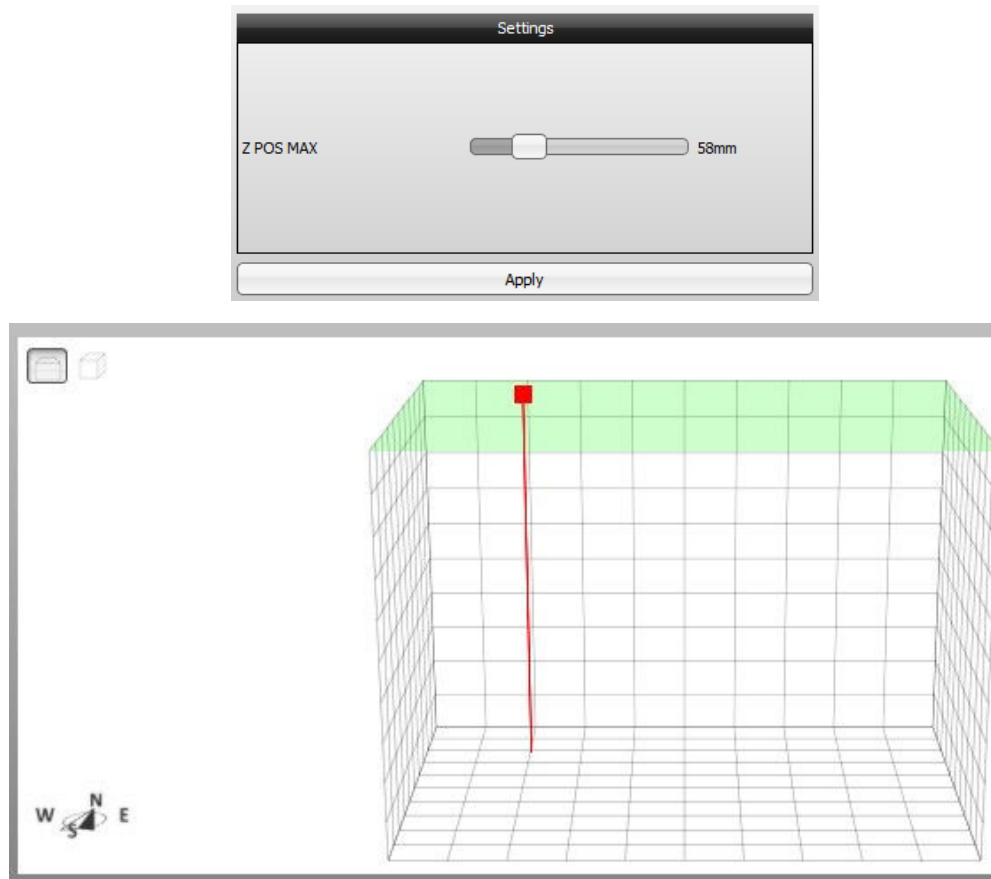

2.3.7.7 Step Seven - Filter Adjustment

The filter adjustments are used to reduce the system jitter (position error when hand is stable) and to define the hand-tracking speed.

Figure 2-38. Filter Adjustment

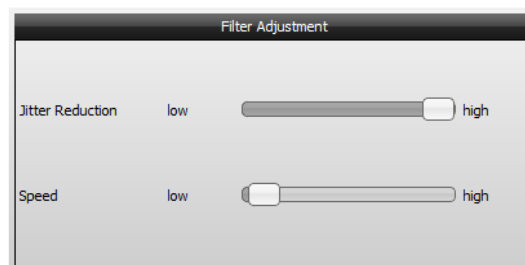

Jitter Reduction

Place your hand on the corner, close to the electrodes (where the jitter is more visible), hold it for a few seconds and track the position using the Position Tracking window. The position should not have high deviation in a distance from 5-10 mm.

Increase the Jitter Reduction parameter value to reduce system jitter. High values will lead to a more lethargic system behavior. A high jitter reduction setting will also slow down the tracking speed and the other way around.

Speed

Use hand gestures to check the tracking speed and track the speed using the Position Tracking window. Increase or decrease the Speed parameter value to speed up or to slow down the tracking speed.

2.3.8 Touch Detection

2.3.8.1 Touch Threshold

North, East, South, West, Center

This field specifies the Signal Deviation values that have to be exceeded to validate the touch event. The range is 0 to 32768. The horizontal darker line in the Level window is adjusted according to the slider value.

To adjust the Touch Detection Threshold, proceed as follows:

1. Touch each electrode in its geometric center and move your finger to the borders of the electrode while touching.
2. Adjust corresponding Touch Threshold according to the displayed SD value while your finger is positioned on the electrode. If touches are missed, you may need to decrease the Touch Threshold.

2.3.8.2 Release Threshold

The Touch state is released if Signal Deviation value drops below a certain threshold. This threshold (horizontal lighter line in the Level window) is an adjustable percentage of Touch Threshold. The Touch Detection Threshold can be adjusted between 50% and 100%.

To adjust it proceed as follows:

1. Touch each electrode in its geometric center and change the hand posture. If Touch state becomes released though you are still touching the surface, decrease Release Threshold.
2. If you lift your finger from the surface, but a Touch state is still reported, increase Release Threshold.

2.3.8.3 Minimum Approach Speed

This field adjusts the minimum approach speed required to detect a Touch event.

If you experience that Touch is only detected if the finger approaches quickly, decrease Min. Approach Speed.

If Min. Approach Speed is too low, false alarms may occur when a finger is approaching slowly, but not touching.

If Min. Approach Speed is set to zero, the touch detection is not dependent of speed and is only configured by the thresholds on SD level.

2.3.8.4 Tap Settings

Max. Tap Time

A Single Tap is only detected when the time between a Touch press and the consecutive release is smaller than Max. Tap Time (see [Figure 2-39](#)). Higher values allow Taps with longer duration.

Figure 2-39. Tap Timings

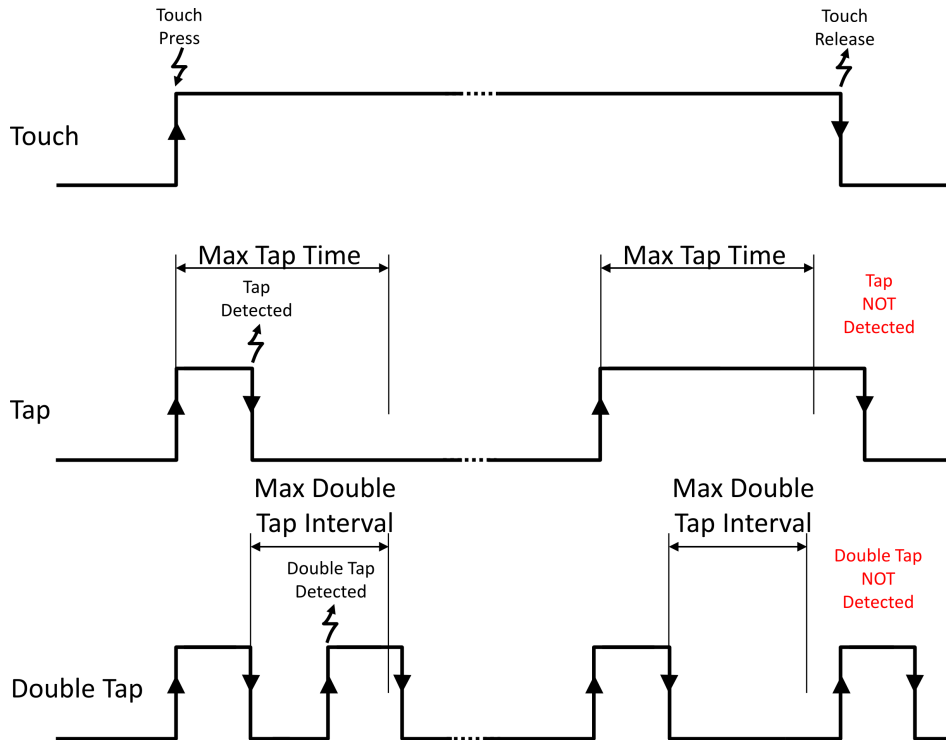

The time can be adjusted using the corresponding slider, which can take values between 0 and 1s.

Max. Double Tap Interval

A Double Tap is detected, when the time between the release of a Single Tap and the consecutive Touch press is smaller than the Max. Double Tap Interval. Higher values allow longer interval between taps. The time can be adjusted using the corresponding slider, that can take values between 0 and 1s.

2.3.9 Presence and Hold Detection

2.3.9.1 Hold and Presence Gestures

Presence and Hold gestures are gestures that are triggered upon a time-out in a defined status flag. If a status flag is active during a certain amount of time, after its last rising edge, the corresponding gesture is triggered.

The status flags that can trigger one of these gestures are:

- The Hand Presence flag is active while the user's hand is in the sensing space.
- Hand Inside flag is active while the user's hand is in the sensing space approximately centered above the sensor.
- Hand Hold flag is active while the hand is not moving and one of the above status flag is active, the selection depends on ActiveOutside.

The behavior of the status flags and corresponding gestures can be adjusted to suit a specific application.

The Gesture and Presence/Hold State visualization windows give immediate feedback upon adjustment.

The adjustable parameters are:

ActiveOutside

Selects if the Hand Hold flag and Presence gesture can be active when user is outside the sensor, but still in sensing space.

- ActiveOutside checked (default) means that Hand Presence is required to set Hand Hold and that Presence Duration starts counting on the rising edge of Hand Presence status flag;
- ActiveOutside unchecked means that Hand Inside is required to set Hand Hold and that Presence Duration starts counting on the rising edge of Hand Inside status flag.

Presence Duration

This is the time during which the selected status flag must be active to trigger a Presence gesture.

This time starts counting on the last rising edge of the selected status flag. The gesture is only triggered once for each rising edge of the flag.

The duration can be adjusted in the range of [0-10]s, in steps of 0.01s; default is 2s.

Hold Duration

This is the time during which the Holding Hand flag must be active to trigger a Hold gesture.

This time starts counting on the last rising edge of the Holding Hand flag. The gesture is only triggered once for each rising edge of the flag.

The duration can be adjusted in the range of [0-10]s, in steps of 0.01s; default is 2s.

Hold Tremble Threshold

This value specifies how much the hand can move and still be considered as holding.

For high values, the hand can move while the Hand Hold flag is still high. For low values, only a slight movement is necessary to clear the Hand Hold flag.

This value can be adjusted in the range of [3,4,...,150]; default is 7.

2.3.10 Gesture Recognition

The Colibri Suite uses Hidden Markov Models (HMM) to provide user-independent gesture recognition. The gesture recognition starts when a hand enters the sensing area, or when a movement is detected after a resting period. A gesture ends when the hand leaves or rests inside the sensing area. Gestures can have various sizes and can be performed at various speeds, within defined limits. For instance, gesture recognition does not trigger when the movement of a gesture is very slow or particularly fast.

Several parameters can be adjusted to optimize gesture recognition for particular situations. Adjust them by using the respective slider or value boxes.

The Gesture and XYZ Position visualization windows give immediate feedback upon adjustments (see the following sub-sections).

2.3.10.1 Trigger Calibration

The Colibri Suite can use the Flick gestures to force a system calibration (system adaptation to environmental changes).

As it is recommended that, when executing a calibration, the sensor is not influenced by the user. The system takes advantage of the fact that, immediately after a Flick, the hand is outside the sensitive area, to trigger a Calibration scan at that moment.

The idle system is properly calibrated when the Signal Deviation of all channels is at or near zero.

Immediate feedback is given by the calibration indication in Aurea Status Bar. Each time a selected gesture is performed, the calibration indication blinks.

Note: Only Flicks that cross the entire sensitive area will trigger Calibration scans.

To select the gestures that trigger a system calibration, check the corresponding check box. Up to four Flick gestures can be selected.

2.3.10.2 Z Position Limit

(MGC3130 only).

This step allows the definition of the Minimum Z-Position Level for each gesture independently. These gestures are only valid if, during the entire gesture execution, the Z position is above the defined Minimum Z-Position Level. The value can be adjusted in the corresponding slider. The range of the parameter is the same as the range of position estimation, from 0 to 65535.

If the gesture has no height restrictions, the feature can be disabled by setting the value to zero.

To adjust the Minimum Z-Position Level, proceed as follows:

1. Adjust the slider to the maximum value.
2. Perform the gesture with the typical hand posture and at the minimum distance desired for the application.
3. Decrease the value until the gestures are correctly recognized. Lower values mean gestures can be recognized at lower Z-Position levels. Gestures performed at higher distances should be recognized.

Note:

1. Only Flick and Discrete Circular gestures can be selected.
2. This feature depends on Position Tracking. If Position Tracking is disabled or incorrectly parameterised, the activation of this feature may lead to bad gesture recognition performance.

2.3.10.3 Gesture Duration

This step selects the gestures which should have duration limits and adjusts the minimum and the maximum duration for each gesture independently.

The gestures are only valid if their duration is between the defined minimum and maximum values (Min. Duration < Gesture Duration < Max. Duration).

The durations can be adjusted using the corresponding slider, that can take values between 0 and 2000 ms.

If the gesture has no restrictions on duration, this feature can be disabled by unchecking the corresponding check box.

To adjust Min. and Max. Duration time, proceed as follows:

1. Adjust the slider of Min. Duration to a higher value;
2. Perform the corresponding gestures with the highest speed allowed for the application;
3. Decrease the slider until the gestures are recognized correctly;
4. Adjust the slider of Max. Duration to a lower value, above Min. Duration;
5. Perform the corresponding gestures with the lowest speed allowed for the application;
6. Increase the slider until the gestures are recognized correctly.

2.3.10.4 Double Flick

The Double Flick Max. Duration adjusts the maximum time allowed between two Flicks, to consider a Double Flick. This is the time between the end of the first Flick and the end of the second.

The parameter can be adjusted with the slider from 300 ms to 10s. It affects only the time between two Flick gestures, while Min. and Max. Durations of a single Flick are still independently adjustable.

Note:

1. All parameters adjusted for Flick gestures will take effect also for Edge Flicks and Double Flicks;
2. A warning appears if this parameter is adjusted while Double Flicks are not activated at start-up. In that case it is not possible to see Double Flicks in Gesture visualization windows. Refer to [System Start-up](#) page for more information.

2.3.10.5 Detection Sensitivity

It is a gain which needs to be adjusted depending on expected system noise. With low values, gestures have to be performed very close to the electrodes. High values increase sensitivity but are also less robust to noise. The Detection Sensitivity slider can take values between 0,01 and 2,985.

To adjust Detection Sensitivity, please proceed as follows:

1. For maximum robustness to noise:
 - 1.1. Perform gestures as far away from the sensitive area as allowed by the application;
 - 1.2. Reduce Detection Sensitivity until gestures are no longer detected;
 - 1.3. At this point, amplitude from performed gestures is not enough to trigger gesture start. This is approximately the minimum sensitivity of the application.
2. For maximum system sensitivity:
 - 2.1. Perform gestures close to the sensitive area;

- 2.2. Increase Detection Sensitivity until gestures are no longer detected;
- 2.3. At this point, noise amplitude is enough to trigger gesture start. Noise is mixed with the performed gesture signal and no valid gesture is recognized. This is approximately the maximum sensitivity of the application.

2.3.10.6 Gesture Suppression Time

After touching the surface, when removing the hand, the user can unintentionally trigger a gesture. This feature can prevent that situation by blocking all gestures during a certain time after the sensor touch is released. The time during which gestures are blocked is adjusted with this slider, which takes values from 0 to 1.25s.

Note:

1. If Gesture Suppression Time is active (>0), touch detection also aborts ongoing gesture recognition.
2. If Touch Detection feature is disabled, this feature has no impact.

2.3.10.7 Min. Wave Count



Important: NOT IMPLEMENTED IN THIS VERSION OF AUREA.

2.3.11 AirWheel

The AirWheel is part of the Colibri Suite circular gestures. The AirWheel algorithm estimates a circle trajectory in the (x, y) position data. As a result, the operation is not limited to frame electrode layout and the x-y area defined by the electrode frame.

There is an airwheel counter which can be either increased or decreased for clockwise (CW) or counter-clockwise circles (CCW), respectively.

Direction can be reversed while an AirWheel is being detected, the counter will reflect the change in direction immediately.

The airwheel counter (8-bit) accumulates the angle change during the circular movement. The lower 5 bits of the counter represent the current angular position with a resolution of 32 counts for each full revolution. Each time the angular position crosses zero, a full revolution is counted in the upper 3 bits. If in CW direction it adds one revolution, in CCW it subtracts one.

Figure 2-40 shows a clockwise rotation and the mapping between the value of the lower 5 bits and the angular position.

Figure 2-40. Positive Direction and Minimum Arc Representation

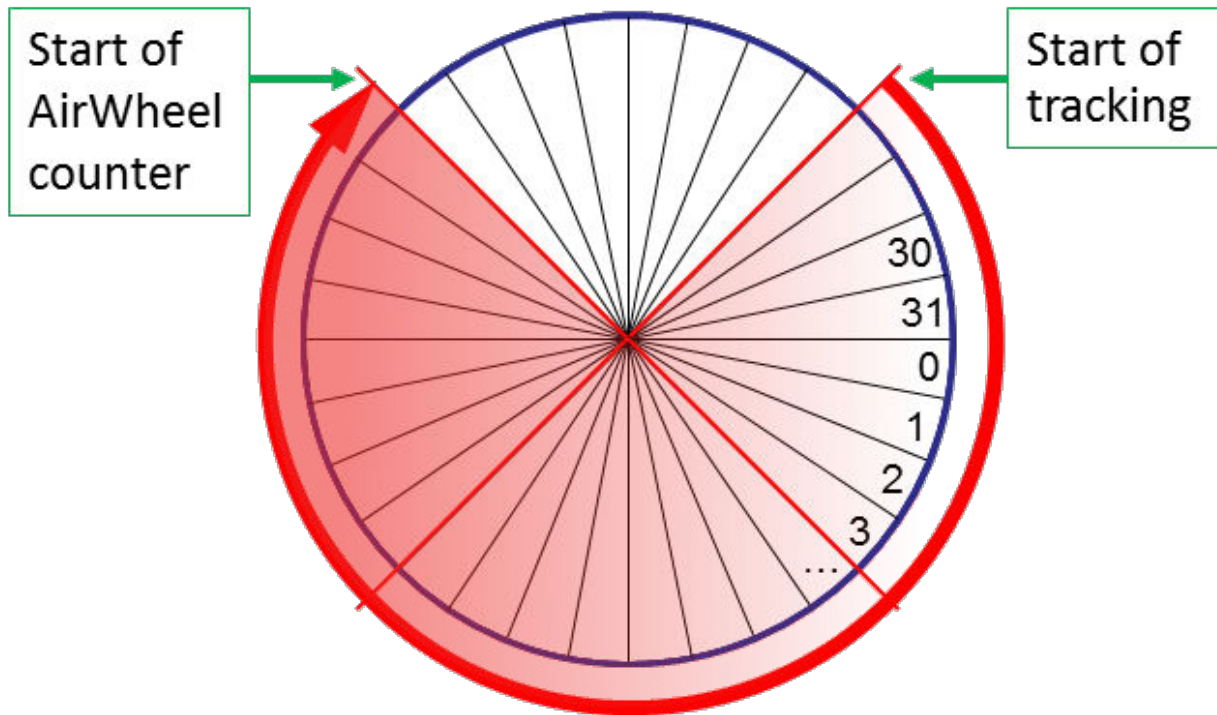

The AirWheel function should work using the default settings for most sensor designs, but can be adjusted to suit a specific application.

2.3.11.1 Minimum Arc Control

Adjusts how many quadrants the user should rotate before the AirWheel counter starts. A higher value means that a bigger arc has to be performed before the counter starts.

The value can be adjusted between 1 and 8 quadrants, default is 3.

Figure 2-40 shows the 3 quadrants required between "Start of position tracking", when user starts rotating, until "Start of AirWheel counter", when counter starts to be updated.

Higher Minimum Arc means the user should rotate more before the counter starts updating. Low Minimum Arc may lead to unintended AirWheel recognition when user is performing other movement in the sensitive area. The Minimum Arc control also affects the Discrete Circle gestures. The same arc has to be performed to recognize a Discrete Circle gesture.

2.3.11.2 AirWheel Blocking Outside the Electrode Control

When the hand crosses an electrode from within the sensing space between the electrodes, the AirWheel may start to rotate in the opposite direction. The AirWheel Blocking Control is used to avoid this situation, by blocking the airwheel counter when the hand crosses an electrode from within the sensing space between the electrodes. The blocking control blocks the airwheel counter until the hand re-enters the sensing space within the electrodes.

The blocking outside the electrode control may be appropriate to use for big electrode sizes but should be disabled for small electrodes where the hand would naturally extend over and beyond the electrodes, while making the Airwheel gesture.



Important: The Discrete Circle gestures and AirWheel are exclusive. The AirWheel has priority over Discrete Circles. When the AirWheel is enabled then only AirWheel information will be reported. To use the Discrete Circles gestures, the application has to enable the clockwise and/or counterclockwise gestures and disable the AirWheel. Refer to [System Start-Up](#) page for more information.

2.3.12 Saving Parameterization Results

Throughout the various parameterization windows, the three buttons on the top right of the page can be used to:

- **Flash** parameter changes to the GestIC chip
- **Save** parameter changes into a new '.enz' file, combining it with the firmware entered into the [Firmware Selection](#) window.
- **Exit** the **Setup** tab:

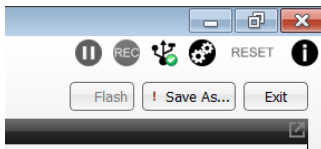

2.3.12.1 Store to Flash Memory on GestIC

Selecting this button permanently stores any parameterization changes into Flash.

2.3.12.2 Save to new '.enz' library file

After parameterization of a new design the new parameters can be combined with the existing firmware to create a new library file that can be used to correctly program devices with parameters for that sensor design.

Select the **Save as** button and follow the instructions to save the '.enz' file in the desired location.

2.3.12.3 Exiting Parameterization

To exit parametrization select the **Exit** button. The '[Synchronization in progress](#)' window will pop up for a few seconds and then all Aurea tabs will become available again.

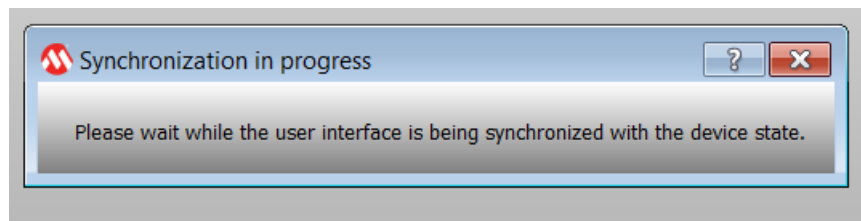

The Colibri Suite Parameterization Results can be stored permanently into the MGC3XX0 controller Flash.

2.4 Demo Tab

Four applications can be launched in the **Demo** tab:

- Cube Demo
- Slide Control
- Cursor Control
- Media Player

Figure 2-41. Demo Tab



2.4.1 Full Screen Cube

The Full Screen Cube application demonstrates the Gesture Cube controlled by the MGC3XX0. Start the application and rotate the cube by moving your hand over the sensing area of your GestIC device. Quit the application at any time by using the <Esc> key on your keyboard.

2.4.2 Slide Control

Slide Control allows the user to control applications by using gestures. Three simple Flick gestures are mapped to predefined keys emulating keystrokes (refer to [Table 2-4](#)).

Table 2-4. Gesture Support in Slide Control

Symbol	Gesture	Windows Key
↑	Flick South to North	<F5>
←	Flick East to West	<←>
→	Flick West to East	<→>

For example, control Microsoft PowerPoint® with gestures as follows:

1. Click **Slide Control** in the Applications section.
2. Open a Microsoft PowerPoint presentation of your choice.
3. Perform Flick gesture from South to North to start presentation.
4. Perform Flick gesture from East to West to go to next slide.
5. Perform Flick gesture from West to East to go to previous slide.
6. Deactivate **Slide Control** within Aurea to quit.

2.4.3 Cursor Control

The Cursor Control application demonstrates the PC mouse cursor controlled by the MGC3XX0. Start the application and move the mouse cursor by sliding your hand over the sensing area of your GestIC device. Quit the application at any time by using the <Esc> key on your keyboard.

2.4.4 Media Player

This button opens Windows Media Player, which can be controlled in the following fashion:

1. AirWheel gesture controls Volume.
2. **East > West** and **West > East** flicks select the Next/Previous track.

3. Advanced Aurea Features

3.1 Logging Sensor Data

It is possible to log and store the data streamed from the MGC3XX0 controller to the PC. This can be used for observing data over long time periods and for system debugging. The log file contains:

Message: All messages sent from the MGC3XX0 in hex format.

Data: Sensor Data decoded from the respective messages. The data fields contain position, uncalibrated sensor data, Signal Deviation and gestures.

Status: Status information from the Colibri Suite decoded from the respective messages. The data fields contain Operation mode, working frequency, calibration and Reset events.



Important: The kind of messages being logged depends on the active **Aurea** tab, and the content displayed inside (refer also to Section 3.1.2 [Log File Content and Format](#)).

3.1.1 Record a Log File

To start logging data:

1. Press the **REC** button in the upper right corner of Aurea. Aurea immediately starts logging data in the background. The logged data includes a 30-second history.
2. In the dialog box confirm the file name and press **OK**.
3. Press **REC** again to stop the logging process.

3.1.2 Log File Content and Format

The log file is a text file containing consecutive messages separated by line feeds. Individual data fields are tab separated. The kind of data being logged depends on the active Aurea tab, and the content displayed inside. If there are data which are not logged, the respective data fields are kept empty. An example of the log file is shown in [Figure 3-1](#).

Figure 3-1. Log File Example

```
Gestic Library: 0.2.18(RC7)
DATE: 06/02/2013
TIME: 11:26:36
TIME (s) MESSAGE Byte 1 Byte 2 ...
TIME (s) DATA Pos X Pos y Pos z CIC S CIC W CIC N CIC E CIC C SD S SD W SD N SD E SD C Gesture
TIME (s) STATUS Running FTX CalInfo Reset
5.32 MESSAGE 84 0 0 83  AA 63 80 0 5 42 14 20 30 2E 32 2E
5.32 STATUS reset
6.163 MESSAGE 10 0 0 98 0 0 0 40 0 0 0 0 0 0 0 0
6.163 MESSAGE 34 8 1 8F 43 9F 80 0 65 23 B3 45 FD 94 CC 45
6.163 DATA 37732.42 38546.62 39075.8 40189.37 36921.88 0 0 0
6.163 STATUS 1 114 0
27.817 MESSAGE 34 8 D3 8F 32 9F 80 0 38 BA CA BF 6C 44 86 40
27.817 DATA -1.58381 4.19585 -0.447005 -2 1.23347
27.817 STATUS 1 128 0
27.818 MESSAGE 10 8 D4 98 0 2 0 0 0 E7 79 2B CB FF FF 0 0
27.818 MESSAGE 34 8 D5 8F 32 1F 80 0 40 16 C9 BF B5 9D 86 40
27.818 STATUS 0 128 0
29.251 MESSAGE 10 8 D6 98 0 2 0 0 0 E7 79 2B CB FF FF 0 0
29.251 MESSAGE 34 8 D7 8F 32 9F 80 0 0 0 0 C0 0 0 0 0
29.251 DATA -2 -2 -2 -2 -2
29.251 STATUS 1 128 10
50.251 MESSAGE 10 0 30 98 0 0 0 0 0 E7 79 AF E8 97 67 0 0
50.251 MESSAGE 34 8 31 8F 42 9F 80 0 F0 0 B8 45 9E E0 CE 45
50.251 DATA 31207 59567 26519 37888.12 38620.08 39223.21 40336 37099.4
50.251 STATUS 1 128 0
```

Table 3-1 and Table 3-2 explain the data fields of the decoded messages.

Table 3-1. Data Detail

Data Field	Description
Position	<p>Positions are logged any time the GestIC Library detects a valid position.</p> <p>The data give the position of the user's hand in the Cartesian coordinate system. Position data of [0, 0, 0] represent the origin of the coordinate system, and data of [65535, 65535, 65535] are the maximum dimension of the sensing space. For coordinate system orientation and origin, refer to Section 2.1 Colibri Suite Tab.</p> <p>Pos x: Range: (0 . . 65535)</p> <p>Pos y: Range: (0 . . 65535)</p> <p>Pos z: Range: (0 . . 65535)</p>
Uncalibrated Signal	<p>The Uncalibrated Signal (CIC) is logged when Uncalibrated Signal or Noise Level is selected in the Signals tab.</p> <p>CIC S (South): Range: (-3.402823e+38 . . 3.402823e+38)</p> <p>CIC W (West): Range: (-3.402823e+38 . . 3.402823e+38)</p> <p>CIC N (North): Range: (-3.402823e+38 . . 3.402823e+38)</p> <p>CIC E (East): Range: (-3.402823e+38 . . 3.402823e+38)</p> <p>CIC C (Center): Range: (-3.402823e+38 . . 3.402823e+38)</p>
Signal Deviation	<p>Signal Deviation (SD) is logged when Signal Deviation or Signal Deviation Mean is selected in the Signals tab or when Signals tab is active.</p> <p>SD S (South): Range: (-3.402823e+38 . . 3.402823e+38)</p> <p>SD W (West): Range: (-3.402823e+38 . . 3.402823e+38)</p> <p>SD N (North): Range: (-3.402823e+38 . . 3.402823e+38)</p> <p>SD E (East): Range: (-3.402823e+38 . . 3.402823e+38)</p> <p>SD C (Center): Range: (-3.402823e+38 . . 3.402823e+38)</p>
Gesture	<p>Gestures are logged any time a gesture is recognized. Gesture info is given in plain text.</p>

Table 3-2. Status Detail

Data Field	Description
Running	<p>Indicates if DSP operating mode is running.</p> <p>Possible values:</p> <p>1 = Running</p> <p>0 = MGC is going into Self Wake-up mode</p>

.....continued	
Data Field	Description
fTx	<p>Tx working frequency in kHz; Appears when the frequency changes</p> <p>Range: (44 . . 115)</p>
CallInfo	<p>Calibration information in hex format.</p> <p>Possible values:</p> <ul style="list-style-type: none"> Bit 1: forced calibration Bit 2: start-up calibration Bit 3: gesture-triggered calibration Bit 4: negative value calibration Bit 5: idle calibration Bit 6: invalidity calibration Bit 10: blocked calibration <p>Range: (0 . . 65535) resp. (b0000 0000 0000 0000 . . b1111 1111 1111 1111)</p>
Reset	<p>Reset is indicated when a reset of MGC3XX0 was successful.</p>

4. Revision History

Doc Rev.	Date	Comments
A	02/2013	Initial document release.
B	08/2013	Updated to support Colibri parametrization. Updated chapters 1, 2, and 3. Aligned with Aurea GUI version 0.4.20 or later.
C	11/2013	Updated chapters 1, 2, and 3; Updated Appendix A.
D	01/2015	Updated document title; added note and updated titles in the Recommended Reading section; Revised step 2 in section 1.1.2 and Note 3 in Section 2.3.2.2; Revised Appendix; other minor corrections.
E	09/2018	Document updated.

5. Appendix A - Glossary

Term	Definition
AFE	Analog front end
Application Host	PC or embedded controller which controls the MGC3XX0
Aurea	MGC3XX0 PC control software with graphical user interface
Colibri Suite	Embedded Digital Signal Processing (DSP) suite within the GestIC [®] Library
Deep Sleep	MGC3XX0 Power-Saving mode
E-field	Electrical field
Frame Electrodes	Rectangular set of four electrodes for E-field sensing
GestIC[®] Technology	Microchip's patented technology providing 3D free-space gesture recognition utilizing the principles of electrical near-field sensing
GestIC[®] Library	Includes the implementation of MGC3XX0 features and is delivered as a binary file pre-programmed on the MGC3XX0
Gesture Recognition	Microchip's stochastic HMM classifier to automatically detect and classify hand movement patterns
Gesture Set	A set of provided hand movement patterns
Hand Brick	Copper coated test block (40x40x70 mm)
HMM	Hidden Markov Model
MGC3030, MGC3130, MGC3140	Single-Zone 3D Gesture Sensing Controller
Position Tracking	GestIC [®] technology feature
Self Wake-Up	Power-Saving mode
Sensing Area	Area enclosed by the four frame electrodes
Sensing Space	Space above Sensing Area
Signal Deviation	Term for the delta of the sensor signal on approach of the hand versus non-approach
Spacer Brick	Spacer between the sensor layer and hand brick (Styrofoam block 40x40xh mm with h= 1/2/3/5/8/12 cm)
SPU	Signal Processing Unit
Approach Detection	GestIC [®] technology feature: Power-Saving mode of the MGC3XX0 with approach detection

The Microchip Web Site

Microchip provides online support via our web site at <http://www.microchip.com/>. This web site is used as a means to make files and information easily available to customers. Accessible by using your favorite Internet browser, the web site contains the following information:

- **Product Support** – Data sheets and errata, application notes and sample programs, design resources, user's guides and hardware support documents, latest software releases and archived software
- **General Technical Support** – Frequently Asked Questions (FAQ), technical support requests, online discussion groups, Microchip consultant program member listing
- **Business of Microchip** – Product selector and ordering guides, latest Microchip press releases, listing of seminars and events, listings of Microchip sales offices, distributors and factory representatives

Customer Change Notification Service

Microchip's customer notification service helps keep customers current on Microchip products. Subscribers will receive e-mail notification whenever there are changes, updates, revisions or errata related to a specified product family or development tool of interest.

To register, access the Microchip web site at <http://www.microchip.com/>. Under "Support", click on "Customer Change Notification" and follow the registration instructions.

Customer Support

Users of Microchip products can receive assistance through several channels:

- Distributor or Representative
- Local Sales Office
- Field Application Engineer (FAE)
- Technical Support

Customers should contact their distributor, representative or Field Application Engineer (FAE) for support. Local sales offices are also available to help customers. A listing of sales offices and locations is included in the back of this document.

Technical support is available through the web site at: <http://www.microchip.com/support>

Microchip Devices Code Protection Feature

Note the following details of the code protection feature on Microchip devices:

- Microchip products meet the specification contained in their particular Microchip Data Sheet.
- Microchip believes that its family of products is one of the most secure families of its kind on the market today, when used in the intended manner and under normal conditions.
- There are dishonest and possibly illegal methods used to breach the code protection feature. All of these methods, to our knowledge, require using the Microchip products in a manner outside the operating specifications contained in Microchip's Data Sheets. Most likely, the person doing so is engaged in theft of intellectual property.
- Microchip is willing to work with the customer who is concerned about the integrity of their code.

- Neither Microchip nor any other semiconductor manufacturer can guarantee the security of their code. Code protection does not mean that we are guaranteeing the product as “unbreakable.”

Code protection is constantly evolving. We at Microchip are committed to continuously improving the code protection features of our products. Attempts to break Microchip’s code protection feature may be a violation of the Digital Millennium Copyright Act. If such acts allow unauthorized access to your software or other copyrighted work, you may have a right to sue for relief under that Act.

Legal Notice

Information contained in this publication regarding device applications and the like is provided only for your convenience and may be superseded by updates. It is your responsibility to ensure that your application meets with your specifications. MICROCHIP MAKES NO REPRESENTATIONS OR WARRANTIES OF ANY KIND WHETHER EXPRESS OR IMPLIED, WRITTEN OR ORAL, STATUTORY OR OTHERWISE, RELATED TO THE INFORMATION, INCLUDING BUT NOT LIMITED TO ITS CONDITION, QUALITY, PERFORMANCE, MERCHANTABILITY OR FITNESS FOR PURPOSE. Microchip disclaims all liability arising from this information and its use. Use of Microchip devices in life support and/or safety applications is entirely at the buyer’s risk, and the buyer agrees to defend, indemnify and hold harmless Microchip from any and all damages, claims, suits, or expenses resulting from such use. No licenses are conveyed, implicitly or otherwise, under any Microchip intellectual property rights unless otherwise stated.

Trademarks

The Microchip name and logo, the Microchip logo, AnyRate, AVR, AVR logo, AVR Freaks, BitCloud, chipKIT, chipKIT logo, CryptoMemory, CryptoRF, dsPIC, FlashFlex, flexPWR, Heldo, JukeBlox, KeeLoq, Kleer, LANCheck, LINK MD, maXStylus, maXTouch, MediaLB, megaAVR, MOST, MOST logo, MPLAB, OptoLyzer, PIC, picoPower, PICSTART, PIC32 logo, Prochip Designer, QTouch, SAM-BA, SpyNIC, SST, SST Logo, SuperFlash, tinyAVR, UNI/O, and XMEGA are registered trademarks of Microchip Technology Incorporated in the U.S.A. and other countries.

ClockWorks, The Embedded Control Solutions Company, EtherSynch, Hyper Speed Control, HyperLight Load, IntelliMOS, mTouch, Precision Edge, and Quiet-Wire are registered trademarks of Microchip Technology Incorporated in the U.S.A.

Adjacent Key Suppression, AKS, Analog-for-the-Digital Age, Any Capacitor, AnyIn, AnyOut, BodyCom, CodeGuard, CryptoAuthentication, CryptoAutomotive, CryptoCompanion, CryptoController, dsPICDEM, dsPICDEM.net, Dynamic Average Matching, DAM, ECAN, EtherGREEN, In-Circuit Serial Programming, ICSP, INICnet, Inter-Chip Connectivity, JitterBlocker, KleerNet, KleerNet logo, memBrain, Mindi, MiWi, motorBench, MPASM, MPF, MPLAB Certified logo, MPLIB, MPLINK, MultiTRAK, NetDetach, Omniscient Code Generation, PICDEM, PICDEM.net, PICKit, PICtail, PowerSmart, PureSilicon, QMatrix, REAL ICE, Ripple Blocker, SAM-ICE, Serial Quad I/O, SMART-I.S., SQI, SuperSwitcher, SuperSwitcher II, Total Endurance, TSHARC, USBCheck, VariSense, ViewSpan, WiperLock, Wireless DNA, and ZENA are trademarks of Microchip Technology Incorporated in the U.S.A. and other countries.

SQTP is a service mark of Microchip Technology Incorporated in the U.S.A.

Silicon Storage Technology is a registered trademark of Microchip Technology Inc. in other countries.

GestIC is a registered trademark of Microchip Technology Germany II GmbH & Co. KG, a subsidiary of Microchip Technology Inc., in other countries.

All other trademarks mentioned herein are property of their respective companies.

© 2018, Microchip Technology Incorporated, Printed in the U.S.A., All Rights Reserved.

ISBN: 978-1-5224-3497-9

Quality Management System Certified by DNV

ISO/TS 16949

Microchip received ISO/TS-16949:2009 certification for its worldwide headquarters, design and wafer fabrication facilities in Chandler and Tempe, Arizona; Gresham, Oregon and design centers in California and India. The Company's quality system processes and procedures are for its PIC[®] MCUs and dsPIC[®] DSCs, KEELOQ[®] code hopping devices, Serial EEPROMs, microperipherals, nonvolatile memory and analog products. In addition, Microchip's quality system for the design and manufacture of development systems is ISO 9001:2000 certified.

Worldwide Sales and Service

AMERICAS	ASIA/PACIFIC	ASIA/PACIFIC	EUROPE
<p>Corporate Office 2355 West Chandler Blvd. Chandler, AZ 85224-6199 Tel: 480-792-7200 Fax: 480-792-7277 Technical Support: http://www.microchip.com/support Web Address: www.microchip.com</p> <p>Atlanta Duluth, GA Tel: 678-957-9614 Fax: 678-957-1455</p> <p>Austin, TX Tel: 512-257-3370</p> <p>Boston Westborough, MA Tel: 774-760-0087 Fax: 774-760-0088</p> <p>Chicago Itasca, IL Tel: 630-285-0071 Fax: 630-285-0075</p> <p>Dallas Addison, TX Tel: 972-818-7423 Fax: 972-818-2924</p> <p>Detroit Novi, MI Tel: 248-848-4000</p> <p>Houston, TX Tel: 281-894-5983</p> <p>Indianapolis Noblesville, IN Tel: 317-773-8323 Fax: 317-773-5453 Tel: 317-536-2380</p> <p>Los Angeles Mission Viejo, CA Tel: 949-462-9523 Fax: 949-462-9608 Tel: 951-273-7800</p> <p>Raleigh, NC Tel: 919-844-7510</p> <p>New York, NY Tel: 631-435-6000</p> <p>San Jose, CA Tel: 408-735-9110 Tel: 408-436-4270</p> <p>Canada - Toronto Tel: 905-695-1980 Fax: 905-695-2078</p>	<p>Australia - Sydney Tel: 61-2-9868-6733</p> <p>China - Beijing Tel: 86-10-8569-7000</p> <p>China - Chengdu Tel: 86-28-8665-5511</p> <p>China - Chongqing Tel: 86-23-8980-9588</p> <p>China - Dongguan Tel: 86-769-8702-9880</p> <p>China - Guangzhou Tel: 86-20-8755-8029</p> <p>China - Hangzhou Tel: 86-571-8792-8115</p> <p>China - Hong Kong SAR Tel: 852-2943-5100</p> <p>China - Nanjing Tel: 86-25-8473-2460</p> <p>China - Qingdao Tel: 86-532-8502-7355</p> <p>China - Shanghai Tel: 86-21-3326-8000</p> <p>China - Shenyang Tel: 86-24-2334-2829</p> <p>China - Shenzhen Tel: 86-755-8864-2200</p> <p>China - Suzhou Tel: 86-186-6233-1526</p> <p>China - Wuhan Tel: 86-27-5980-5300</p> <p>China - Xian Tel: 86-29-8833-7252</p> <p>China - Xiamen Tel: 86-592-2388138</p> <p>China - Zhuhai Tel: 86-756-3210040</p>	<p>India - Bangalore Tel: 91-80-3090-4444</p> <p>India - New Delhi Tel: 91-11-4160-8631</p> <p>India - Pune Tel: 91-20-4121-0141</p> <p>Japan - Osaka Tel: 81-6-6152-7160</p> <p>Japan - Tokyo Tel: 81-3-6880-3770</p> <p>Korea - Daegu Tel: 82-53-744-4301</p> <p>Korea - Seoul Tel: 82-2-554-7200</p> <p>Malaysia - Kuala Lumpur Tel: 60-3-7651-7906</p> <p>Malaysia - Penang Tel: 60-4-227-8870</p> <p>Philippines - Manila Tel: 63-2-634-9065</p> <p>Singapore Tel: 65-6334-8870</p> <p>Taiwan - Hsin Chu Tel: 886-3-577-8366</p> <p>Taiwan - Kaohsiung Tel: 886-7-213-7830</p> <p>Taiwan - Taipei Tel: 886-2-2508-8600</p> <p>Thailand - Bangkok Tel: 66-2-694-1351</p> <p>Vietnam - Ho Chi Minh Tel: 84-28-5448-2100</p>	<p>Austria - Wels Tel: 43-7242-2244-39 Fax: 43-7242-2244-393</p> <p>Denmark - Copenhagen Tel: 45-4450-2828 Fax: 45-4485-2829</p> <p>Finland - Espoo Tel: 358-9-4520-820</p> <p>France - Paris Tel: 33-1-69-53-63-20 Fax: 33-1-69-30-90-79</p> <p>Germany - Garching Tel: 49-8931-9700</p> <p>Germany - Haan Tel: 49-2129-3766400</p> <p>Germany - Heilbronn Tel: 49-7131-67-3636</p> <p>Germany - Karlsruhe Tel: 49-721-625370</p> <p>Germany - Munich Tel: 49-89-627-144-0 Fax: 49-89-627-144-44</p> <p>Germany - Rosenheim Tel: 49-8031-354-560</p> <p>Israel - Ra'anana Tel: 972-9-744-7705</p> <p>Italy - Milan Tel: 39-0331-742611 Fax: 39-0331-466781</p> <p>Italy - Padova Tel: 39-049-7625286</p> <p>Netherlands - Drunen Tel: 31-416-690399 Fax: 31-416-690340</p> <p>Norway - Trondheim Tel: 47-72884388</p> <p>Poland - Warsaw Tel: 48-22-3325737</p> <p>Romania - Bucharest Tel: 40-21-407-87-50</p> <p>Spain - Madrid Tel: 34-91-708-08-90 Fax: 34-91-708-08-91</p> <p>Sweden - Gothenberg Tel: 46-31-704-60-40</p> <p>Sweden - Stockholm Tel: 46-8-5090-4654</p> <p>UK - Wokingham Tel: 44-118-921-5800 Fax: 44-118-921-5820</p>