

## Ultrafast recovery - 1200 V diode

Datasheet - production data

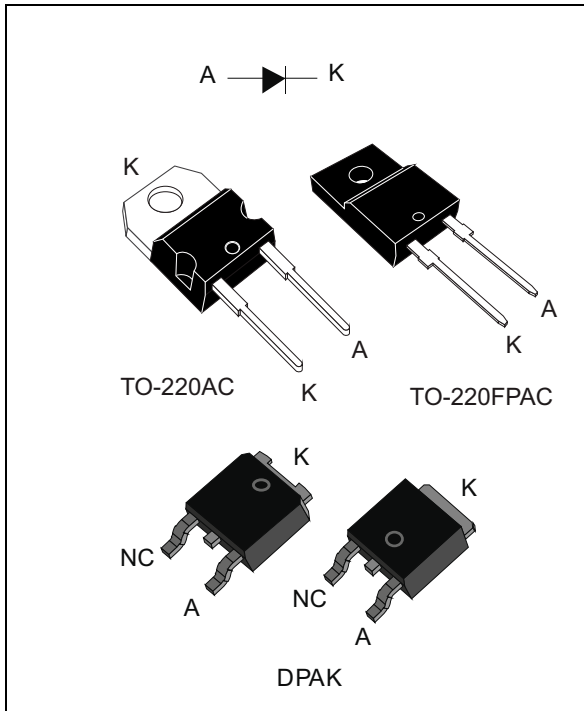

### Description

The high quality design of this diode has produced a device with low leakage current, regularly reproducible characteristics and intrinsic ruggedness. These characteristics make it ideal for heavy duty applications that demand long term reliability.

Such demanding applications include industrial power supplies, motor control, and similar mission-critical systems that require rectification and freewheeling. These diodes also fit into auxiliary functions such as snubber, bootstrap, and demagnetization applications.

The improved performance in low leakage current, and therefore thermal runaway guard band, is an immediate competitive advantage for this device.

**Table 1. Device summary**

Symbol	Value
$I_{F(AV)}$	5 A
$V_{RRM}$	1200 V
$T_j(max)$	175 °C
$V_F$ (typ)	1.25 V
$t_{rr}$ (typ)	48 ns

### Features

- Ultrafast, soft recovery
- Very low conduction and switching losses
- High frequency and/or high pulsed current operation
- High reverse voltage capability
- High junction temperature
- ECOPACK<sup>®</sup>2 compliant component for DPAK on demand
- Insulated package: TO-220FPAC
  - Insulated voltage: 2000  $V_{RMS}$  sine

# 1 Characteristics

**Table 2. Absolute ratings (limiting values at 25 °C, unless otherwise stated)**

Symbol	Parameter		Value	Unit
$V_{RRM}$	Repetitive peak reverse voltage		1200	V
$I_{F(RMS)}$	RMS forward current	TO-220AC / TO-220FPAC	30	A
		DPAK	10	
$I_{F(AV)}$	Average forward current, $\delta = 0.5$ , square wave	TO-220AC / DPAK	5	A
		TO-220FPAC		
$I_{FRM}$	Repetitive peak forward current	$t_p = 5\ \mu\text{s}$ , $F = 5\ \text{kHz}$ square	60	A
$I_{FSM}$	Surge non repetitive forward current	$t_p = 10\ \text{ms}$ Sinusoidal	55	A
$T_{stg}$	Storage temperature range		-65 to + 175	$^\circ\text{C}$
$T_j$	Maximum operating junction temperature		175	$^\circ\text{C}$

**Table 3. Thermal resistance**

Symbol	Parameter		Value	Unit
$R_{th(j-c)}$	Junction to case	TO-220AC / DPAK	2.5	$^\circ\text{C/W}$
		TO-220FPAC	5.8	

**Table 4. Static electrical characteristics**

Symbol	Parameter	Test conditions		Min.	Typ.	Max.	Unit
$I_R^{(1)}$	Reverse leakage current	$T_j = 25^\circ\text{C}$	$V_R = V_{RRM}$			5	$\mu\text{A}$
		$T_j = 125^\circ\text{C}$			3	30	
$V_F^{(2)}$	Forward voltage drop	$T_j = 25^\circ\text{C}$	$I_F = 5\ \text{A}$			2.20	V
		$T_j = 125^\circ\text{C}$			1.30	2.00	
		$T_j = 150^\circ\text{C}$			1.25	1.90	

1. Pulse test:  $t_p = 5\ \text{ms}$ ,  $\delta < 2\%$
2. Pulse test:  $t_p = 380\ \mu\text{s}$ ,  $\delta < 2\%$

To evaluate the conduction losses use the following equation:

$$P = 1.5 \times I_{F(AV)} + 0.08 I_{F(RMS)}^2$$

Table 5. Dynamic characteristics

Symbol	Parameter	Test conditions	Min.	Typ.	Max.	Unit
$t_{rr}$	Reverse recovery time	$I_F = 1\text{ A}$ , $di_F/dt = -50\text{ A}/\mu\text{s}$ , $V_R = 30\text{ V}$ , $T_j = 25\text{ }^\circ\text{C}$			95	ns
		$I_F = 1\text{ A}$ , $di_F/dt = -100\text{ A}/\mu\text{s}$ , $V_R = 30\text{ V}$ , $T_j = 25\text{ }^\circ\text{C}$		48	70	
$I_{RM}$	Reverse recovery current	$I_F = 5\text{ A}$ , $di_F/dt = -200\text{ A}/\mu\text{s}$ , $V_R = 600\text{ V}$ , $T_j = 125\text{ }^\circ\text{C}$		11	16	A
S	Softness factor	$I_F = 5\text{ A}$ , $di_F/dt = -200\text{ A}/\mu\text{s}$ , $V_R = 600\text{ V}$ , $T_j = 125\text{ }^\circ\text{C}$		2		
$t_{fr}$	Forward recovery time	$I_F = 5\text{ A}$ $di_F/dt = 50\text{ A}/\mu\text{s}$ $V_{FR} = 1.5 \times V_{Fmax}$ , $T_j = 25\text{ }^\circ\text{C}$			400	ns
$V_{FP}$	Forward recovery voltage	$I_F = 5\text{ A}$ , $di_F/dt = 50\text{ A}/\mu\text{s}$ , $T_j = 25\text{ }^\circ\text{C}$		9.5		V

Figure 1. Conduction losses versus average current

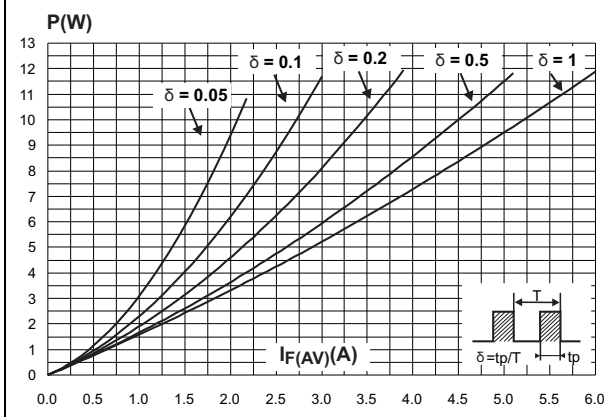

Figure 2. Forward voltage drop versus forward current

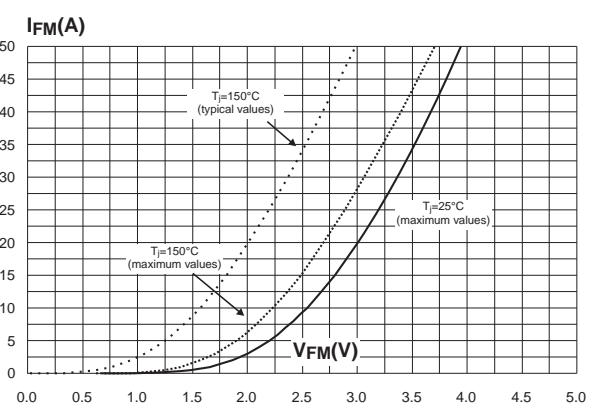

Figure 3. Relative variation of thermal impedance junction to case versus pulse duration

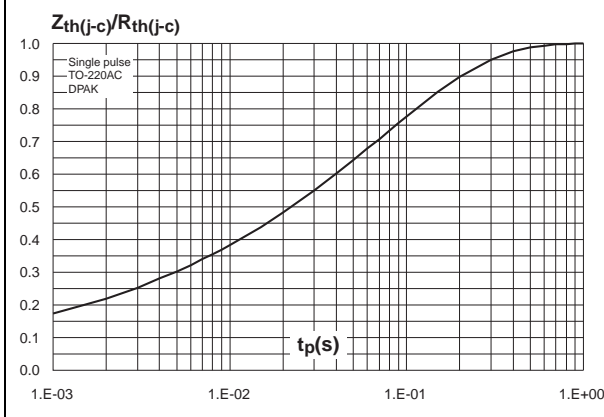
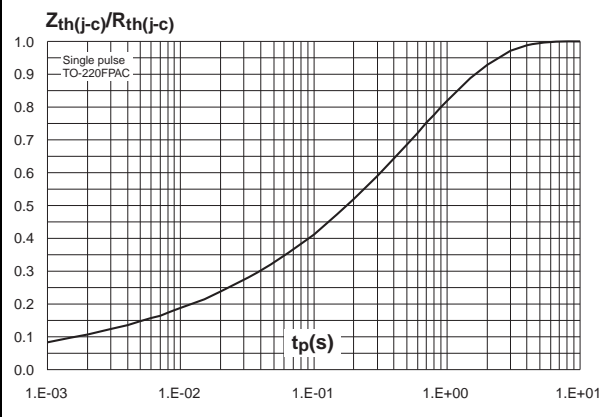
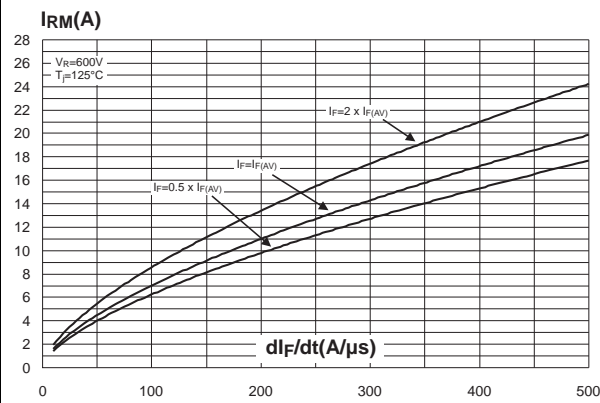

Figure 4. Relative variation of thermal impedance junction to case versus pulse duration



**Figure 5. Peak reverse recovery current versus  $di_F/dt$  (typical values)**



**Figure 6. Reverse recovery time versus  $di_F/dt$  (typical values)**

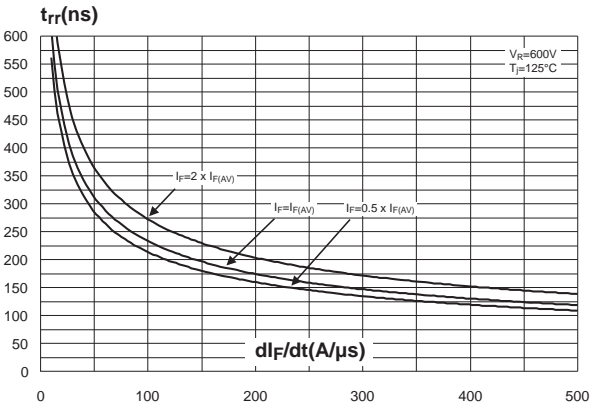

**Figure 7. Reverse recovery charges versus  $di_F/dt$  (typical values)**

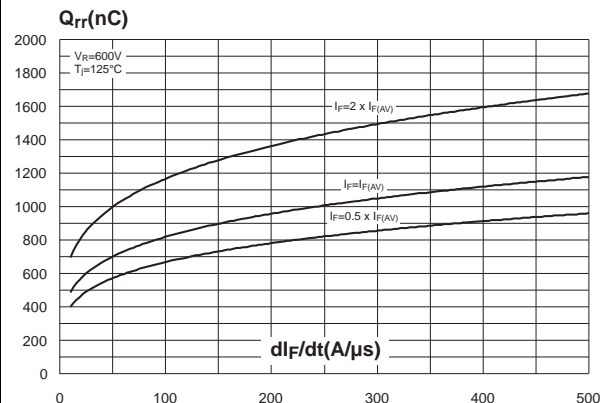

**Figure 8. Softness factor versus  $di_F/dt$  (typical values)**

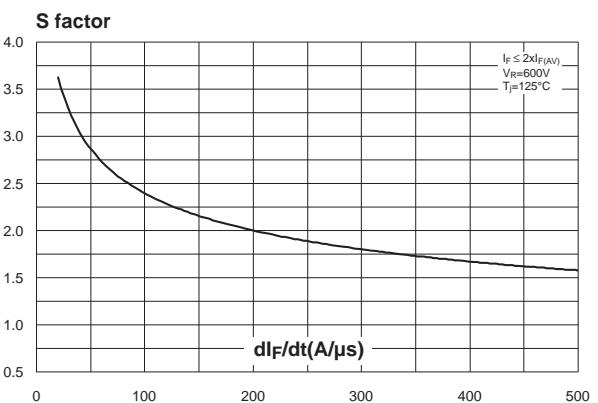

**Figure 9. Relative variations of dynamic parameters versus junction temperature**

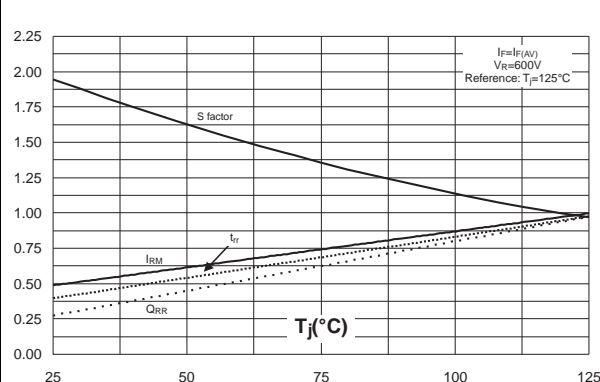

**Figure 10. Transient peak forward voltage versus  $di_F/dt$  (typical values)**

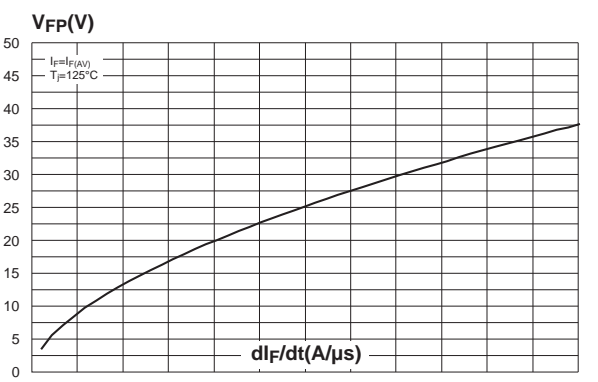

**Figure 11. Forward recovery time versus  $di_F/dt$  (typical values)**

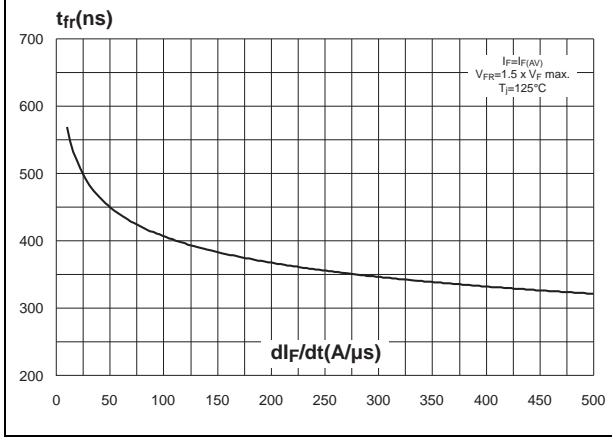

**Figure 12. Junction capacitance versus reverse voltage applied (typical values)**

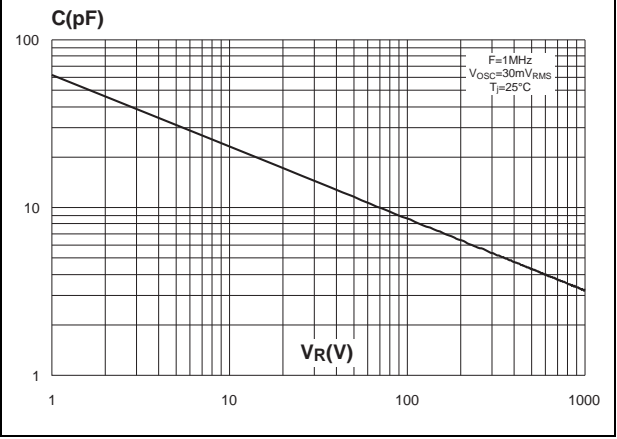

**Figure 13. Thermal resistance junction to ambient versus copper surface under tab**

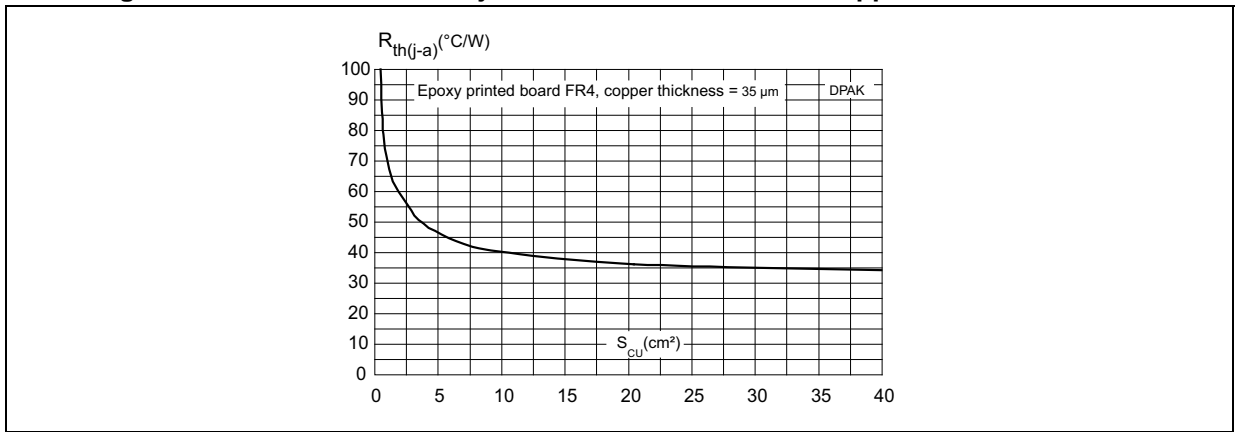

## 2 Package information

- Epoxy meets UL94, V0
- Cooling method: by conduction (C)
- Recommended torque values: 0.55 N·m for TO-220AC and TO-220FPAC
- Maximum torque value: 0.7 N·m for TO-220AC and TO-220FPAC

In order to meet environmental requirements, ST offers these devices in different grades of ECOPACK® packages, depending on their level of environmental compliance. ECOPACK® specifications, grade definitions and product status are available at: [www.st.com](http://www.st.com). ECOPACK® is an ST trademark.

### 2.1 TO-220AC package information

Figure 14. TO-220AC package outline

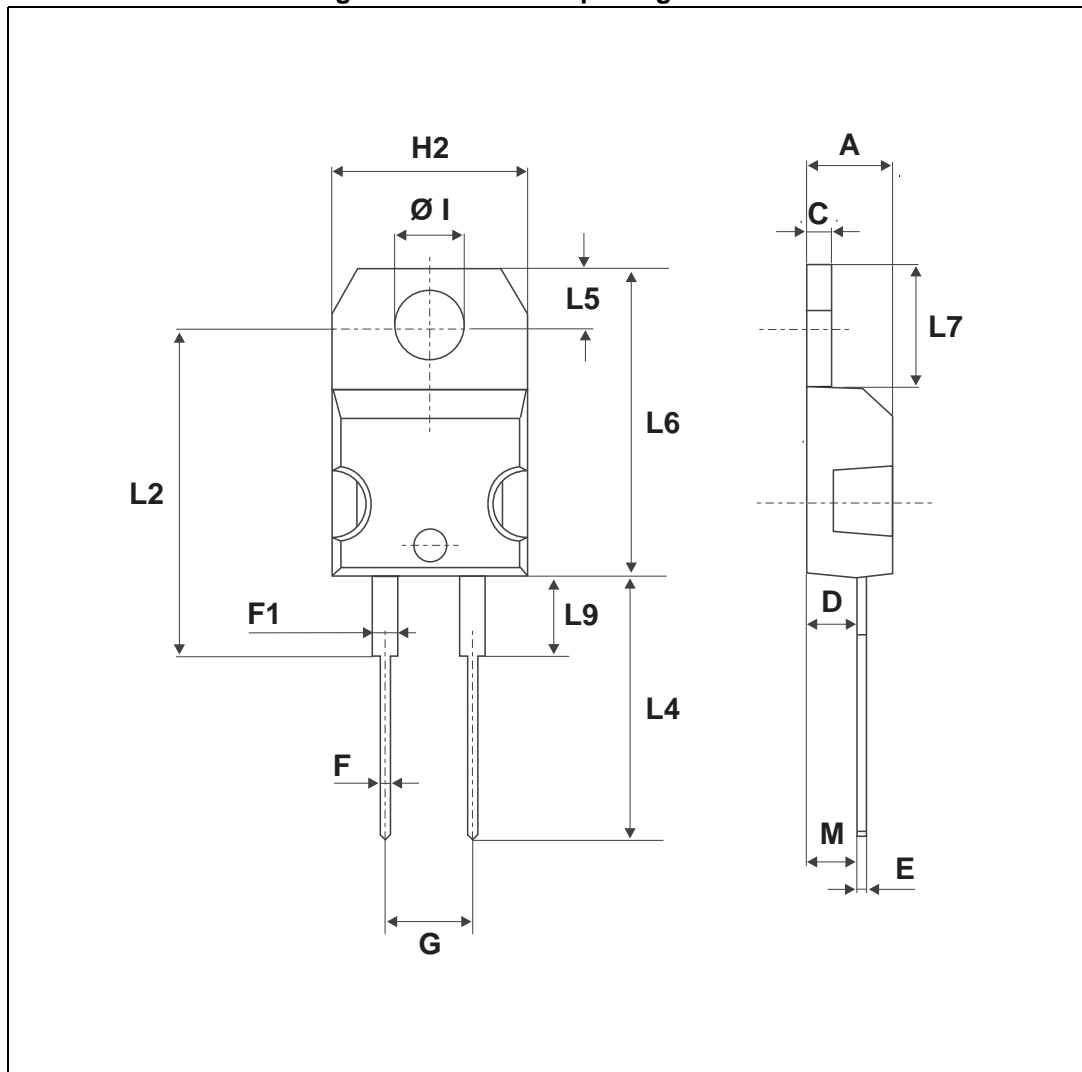

Table 6. TO-220AC package mechanical data

Ref.	Dimensions					
	Millimeters			Inches		
	Min.	Typ.	Max.	Min.	Typ.	Max.
A	4.40		4.60	0.173		0.181
C	1.23		1.32	0.048		0.051
D	2.40		2.72	0.094		0.107
E	0.49		0.70	0.019		0.027
F	0.61		0.88	0.024		0.034
F1	1.14		1.70	0.044		0.066
G	4.95		5.15	0.194		0.202
H2	10.00		10.40	0.393		0.409
L2		16.40 typ.			0.645 typ.	
L4	13.00		14.00	0.511		0.551
L5	2.65		2.95	0.104		0.116
L6	15.25		15.75	0.600		0.620
L7	6.20		6.60	0.244		0.259
L9	3.50		3.93	0.137		0.154
M		2.60 typ.			0.102 typ.	
Diam. I	3.75		3.85	0.147		0.151

## 2.2 TO-220FPAC package information

Figure 15. TO-220FPAC package outline

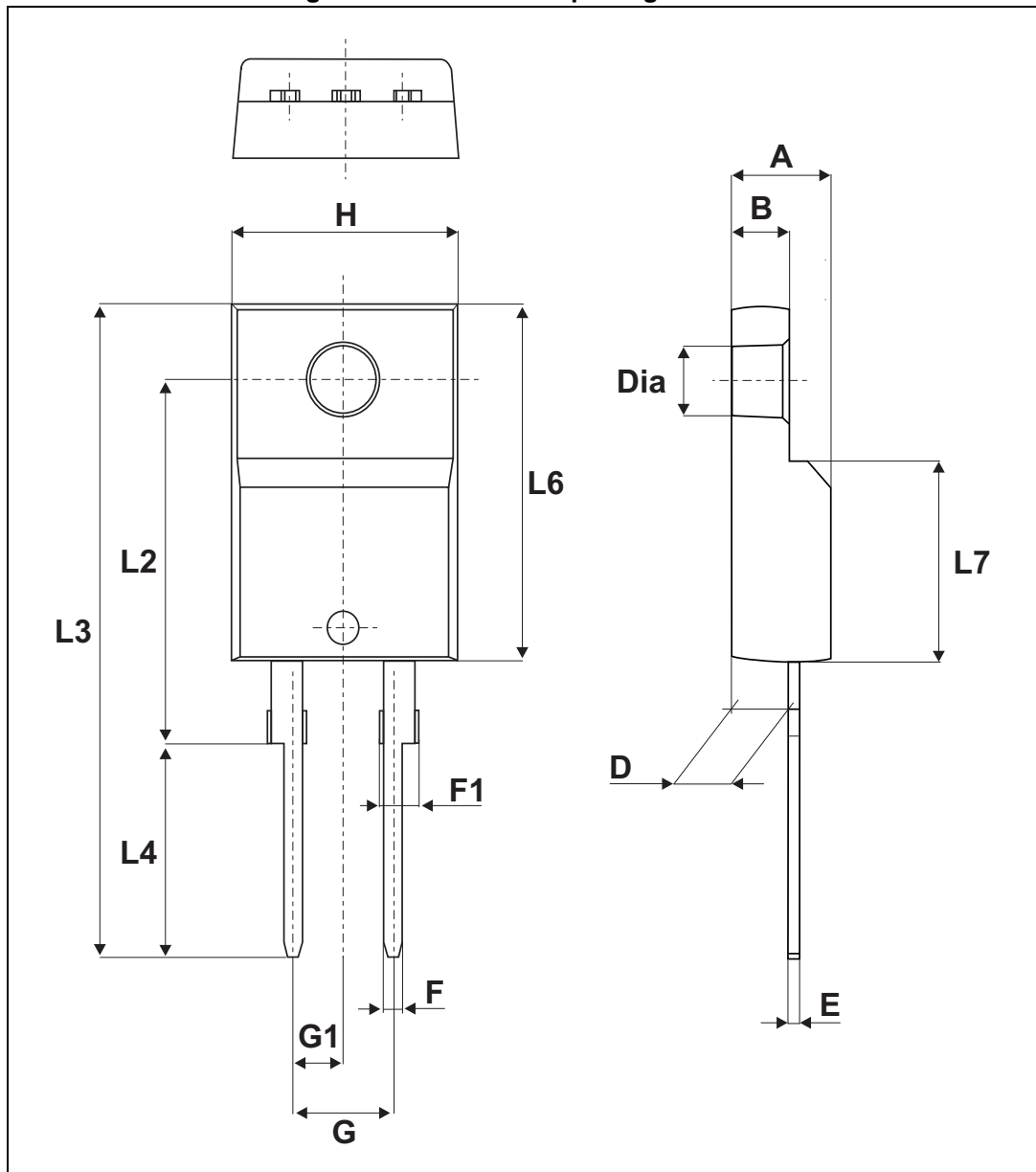

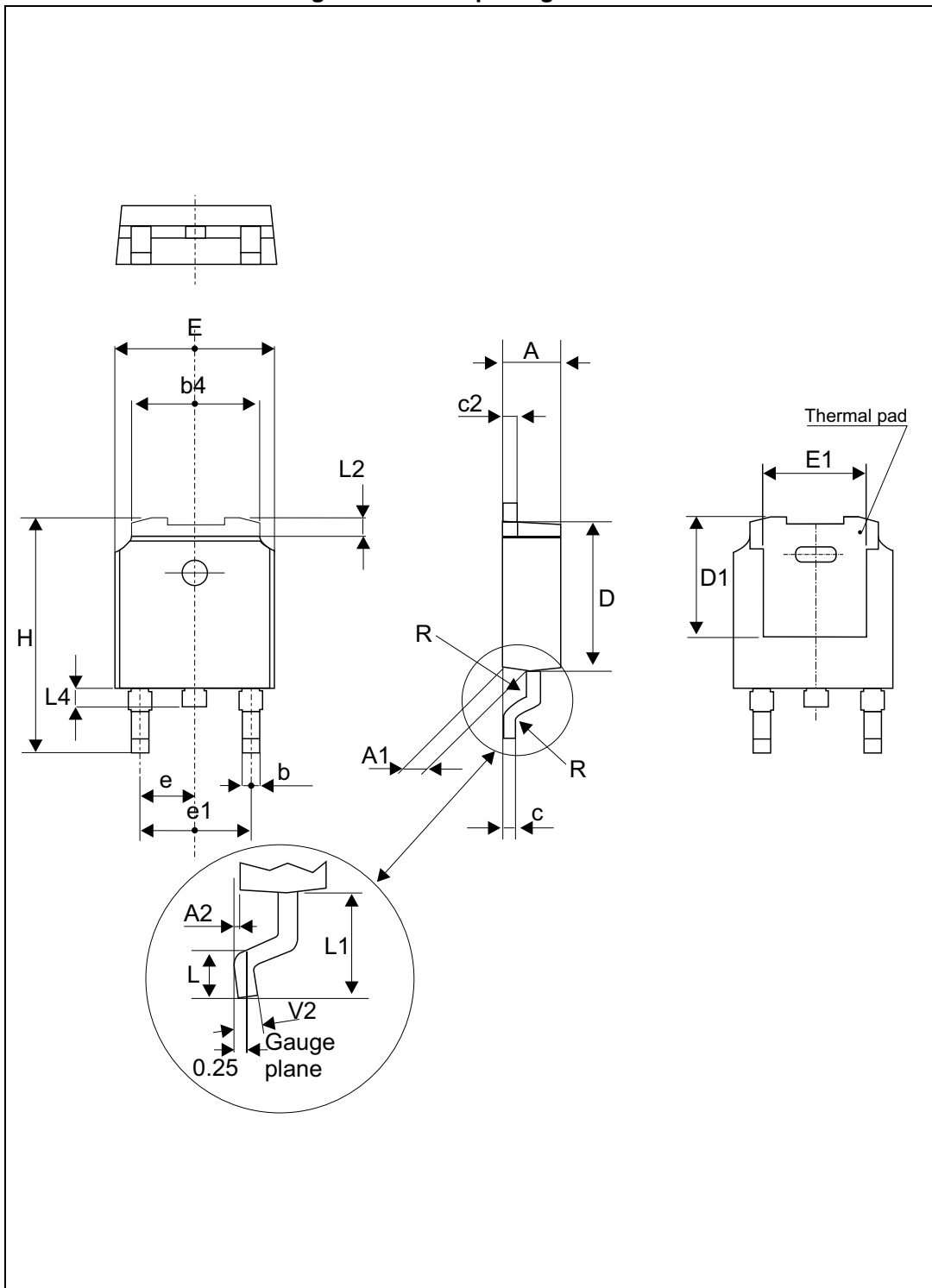

Table 7. TO-220FPAC package mechanical data

Ref.	Dimensions					
	Millimeters			Inches		
	Min.	Typ.	Max.	Min.	Typ.	Max.
A	4.40		4.60	0.173		0.181
B	2.50		2.70	0.098		0.106
D	2.50		2.75	0.098		0.108
E	0.45		0.70	0.018		0.027
F	0.75		1.00	0.030		0.039
F1	1.15		1.70	0.045		0.067
G	4.95		5.20	0.195		0.205
G1	2.40		2.70	0.094		0.106
H	10.00		10.40	0.393		0.409
L2		16.00 Typ.			0.630 Typ.	
L3	28.60		30.60	1.126		1.205
L4	9.80		10.60	0.386		0.417
L6	15.90		16.40	0.626		0.646
L7	9.00		9.30	0.354		0.366
Dia.	3.00		3.20	0.118		0.126

### 2.3 DPAK package information

Figure 16. DPAK package outline



Note: This package drawing may slightly differ from the physical package. However, all the specified dimensions are guaranteed.

Table 8. DPAK package mechanical data

Ref.	Dimensions					
	Millimeters			Inches		
	Min.	Typ.	Max.	Min.	Typ.	Max.
A	2.18		2.40	0.085		0.094
A1	0.90		1.10	0.035		0.043
A2	0.03		0.23	0.001		0.009
b	0.64		0.90	0.025		0.035
b4	4.95		5.46	0.194		0.214
c	0.46		0.61	0.018		0.024
c2	0.46		0.60	0.018		0.023
D	5.97		6.22	0.235		0.244
D1	4.95		5.60	0.194		0.220
E	6.35		6.73	0.250		0.264
E1	4.32		5.50	0.170		0.216
e		2.28			0.090	
e1	4.40		4.70	0.173		0.185
H	9.35		10.40	0.368		0.409
L	1.00		1.78	0.039		0.070
L2			1.27			0.050
L4	0.60		1.02	0.023		0.040
V2	-8°		+8°	-8°		8°

Figure 17. Footprint (dimensions in mm)

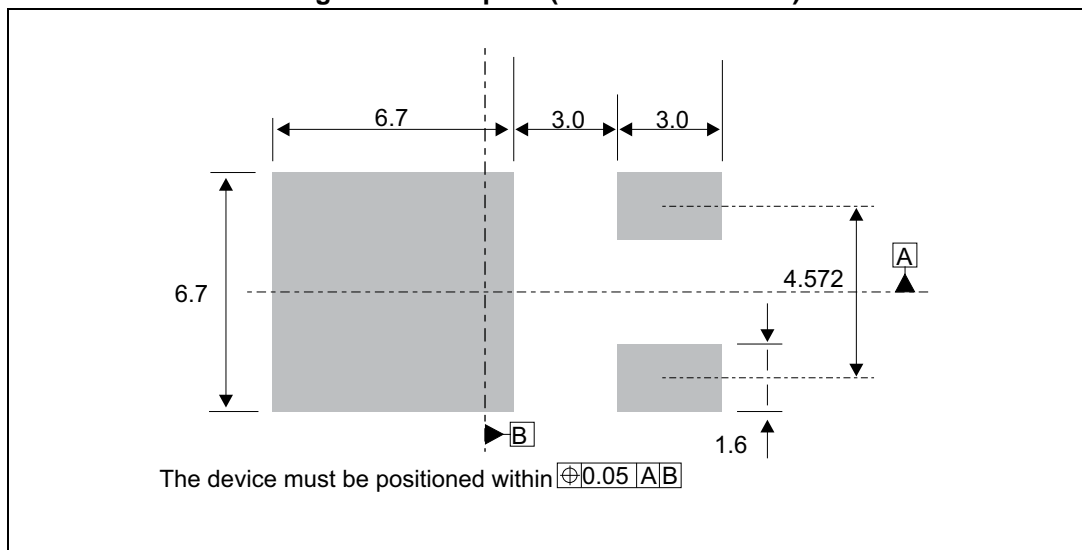

### 3 Ordering information

**Table 9. Ordering information**

Order code	Marking	Package	Weight	Base qty	Delivery mode
STTH512D	STTH512D	TO-220AC	1.86 g	50	Tube
STTH512FP	STTH512FP	TO-220FPAC	1.9 g	50	Tube
STTH512B-TR	STTH512B	DPAK	0.32 g	2500	Tape and reel

### 4 Revision history

**Table 10. Document revision history**

Date	Revision	Changes
02-Mar-2006	1	First issue.
26-Nov-2014	2	Updated DPAK package information and reformatted to current standard.
24-Feb-2016	3	Updated DPAK package information and reformatted to current standard.

**IMPORTANT NOTICE – PLEASE READ CAREFULLY**

STMicroelectronics NV and its subsidiaries ("ST") reserve the right to make changes, corrections, enhancements, modifications, and improvements to ST products and/or to this document at any time without notice. Purchasers should obtain the latest relevant information on ST products before placing orders. ST products are sold pursuant to ST's terms and conditions of sale in place at the time of order acknowledgement.

Purchasers are solely responsible for the choice, selection, and use of ST products and ST assumes no liability for application assistance or the design of Purchasers' products.

No license, express or implied, to any intellectual property right is granted by ST herein.

Resale of ST products with provisions different from the information set forth herein shall void any warranty granted by ST for such product.

ST and the ST logo are trademarks of ST. All other product or service names are the property of their respective owners.

Information in this document supersedes and replaces information previously supplied in any prior versions of this document.

© 2016 STMicroelectronics – All rights reserved

