



ULTRA FLAT GAIN, LOW NOISE

Monolithic Amplifier

PGA-105+

Mini-Circuits

50Ω 0.04 to 2.6 GHz

THE BIG DEAL

- Excellent gain flatness, ± 0.25 dB over 0.1-2.0 GHz
- Gain, 15.0 dB typ. at 2 GHz
- High IP3, 39 dBm typ. at 0.9 GHz
- P1dB 19.3 dBm typ. at 2 GHz
- Low noise figure, 1.9 dB at 2 GHz
- No external matching components required

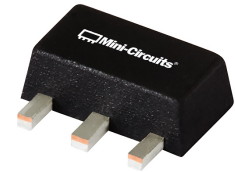

Generic photo used for illustration purposes only

CASE STYLE: DF782

+RoHS Compliant

The +Suffix identifies RoHS Compliance. See our web site for RoHS Compliance methodologies and qualifications

APPLICATIONS

- Base station infrastructure
- Portable Wireless
- CATV & DBS
- MMDS & Wireless LAN
- LTE

PRODUCT OVERVIEW

PGA-105+ (RoHS compliant) is an advanced ultra flat gain amplifier fabricated using E-PHEMT technology and offers extremely high dynamic range over a broad frequency range and with low noise figure. In addition, the PGA-105+ has good input and output return loss over a broad frequency range without the need for external matching components. It is enclosed in a SOT-89 package for good thermal performance.

KEY FEATURES

Feature	Advantages
Broad Band: 0.04 to 2.6 GHz	Broadband covering primary wireless communications bands: Cellular, PCS, LTE, WiMAX
Ultra Flat Gain: ± 0.25 dB typ. 0.1 to 2 GHz	Ideal for use in broad band or multi band applications where gain flatness is critical.
High IP3 Versus DC power Consumption: 39 dBm typical at 0.9 GHz 35 dBm typical at 2 GHz	The PGA-105+ provides good IP3 performance relative to device size and power consumption. The combination of the design and E-PHEMT Structure provides enhanced linearity over a broad frequency range as evidence in the IP3 being typically 15 dB above the P 1dB point. This feature makes this amplifier ideal for use in: <ul style="list-style-type: none"> • Driver amplifiers for complex waveform up converter paths • Drivers in linearized transmit systems • Secondary amplifiers in ultra High Dynamic range receivers
No External Matching Components Required	Unlike competing products, Mini-Circuits PGA-105+ provides outstanding gain flatness and Input and Output Return Loss of 23 dB up to 2.6 GHz without the need for any external matching components.
Low Noise Figure: 1.7 - 2.0 dB typ.	A unique feature of the PGA-105+ which separates this design from all competitors is the low noise figure performance in combination with the high dynamic range.





ULTRA FLAT GAIN, LOW NOISE

Monolithic Amplifier

PGA-105+

Mini-Circuits

ELECTRICAL SPECIFICATIONS⁽¹⁾ AT 25°C, 50Ω AND 5V, UNLESS NOTED OTHERWISE

Parameter	Condition (GHz)	Min.	Typ.	Max.	Units
Frequency Range		0.04		2.6	GHz
Gain	0.04	—	16.4	—	dB
	0.5	—	15.2	—	
	0.9	—	15.1	—	
	2.0	13.8	15.2	16.8	
	2.6	—	15.9	—	
Gain Flatness	0.1 - 2.0		±0.25		dB
Noise Figure	0.04	—	1.7	—	dB
	0.5	—	2.0	—	
	0.9	—	1.9	—	
	2.0	—	1.9	2.7	
	2.6	—	2.1	—	
Input Return Loss	0.04		11.6		dB
	0.5		20.4		
	0.9		18.4		
	2.0		18.9		
	2.6		9.3		
Output Return Loss	0.04		12.9		dB
	0.5		23.3		
	0.9		20.1		
	2.0		14.7		
	2.5		9.1		
Reverse Isolation	2.0		22.2		dB
Output Power @1 dB compression	0.04		20.9		dBm
	0.5		20.7		
	0.9		20.5		
	2.0		19.3		
	2.6		19.3		
Output IP3	0.04		36.1		dBm
	0.5		39.3		
	0.9		39.3		
	2.0		34.7		
	2.6		32.4		
Device Operating Voltage		4.8	5.0	5.2	V
Device Operating Current			63	77	mA
Device Current Variation vs. Temperature ⁽²⁾			67		μA/°C
Device Current Variation vs Voltage			0.0154		mA/mV
Thermal Resistance, junction-to-ground lead			102		°C/W

(1) Measured on Mini-Circuits Characterization test board TB-665+. See Characterization Test Circuit (Fig. 1)

(2) (Current at 85°C – Current at -45°C)/130



ULTRA FLAT GAIN, LOW NOISE

Monolithic Amplifier

PGA-105+

MAXIMUM RATINGS

Parameter	Ratings
Operating Temperature (ground lead)	-40°C to 85°C
Storage Temperature	-65°C to 150°C
Operating Current at 5.0V	94 mA
Power Dissipation	0.47 W
Input Power (CW)	23 dBm (5 minutes max, 17 dBm (continuous))
DC Voltage on Pin 3	5.5 V

Permanent damage may occur if any of these limits are exceeded. Electrical maximum ratings are not intended for continuous normal operation.

DC CURRENT HISTOGRAM

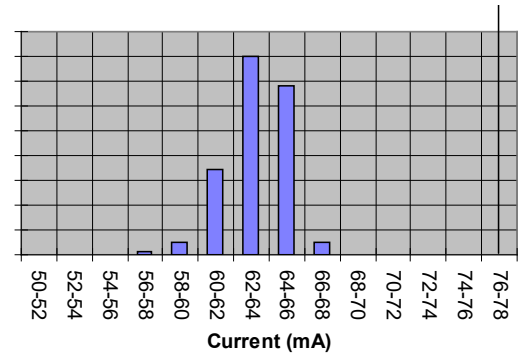

TYPICAL PERFORMANCE WITH APPLICATION CIRCUITS (SEE APPLICATION NOTE, AN-60-063)

Freq. (GHz)	TB-678-105+								TB-733-105+ (unconditionally stable)							
	Gain	Noise Figure	Input Return Loss	Output Return Loss	Output Power @ 1dB comp.	Output IP3	Stability Factor	Stability Measure	Gain	Noise Figure	Input Return Loss	Output Return Loss	Output Power @ 1dB comp.	Output IP3	Stability Factor	Stability Measure
0.04	16.4	1.7	11.6	12.9	20.9	36.1	0.93	0.59	14.4	2.3	8.6	27.6	19.5	34.6	1.14	0.90
0.5	15.2	2.0	20.4	23.3	20.7	39.3	1.10	0.62	14.5	2.0	21.8	22.7	21.0	38.7	1.13	0.65
0.9	15.1	1.9	18.4	20.1	20.5	39.3	1.13	0.66	14.4	1.9	20.6	25.1	21.0	37.4	1.17	0.70
2	15.2	1.9	18.9	14.7	19.3	34.7	1.29	0.80	15.5	1.9	13.8	15.2	18.9	33.6	1.35	0.88
2.6	15.9	2.1	9.3	9.1	19.3	32.4	1.51	0.96	15.1	2.0	10.5	8.5	19.4	33.2	1.83	0.94

SIMPLIFIED SCHEMATIC AND PIN DESCRIPTION



Function	Pin Number	Description
RF-IN	1	RF input pin. This pin requires the use of an external DC blocking capacitor chosen for the frequency of operation.
RF-OUT and DC-IN	3	RF output and bias pin. DC voltage is present on this pin; therefore a DC blocking capacitor is necessary for proper operation. An RF choke is needed to feed DC bias without loss of RF signal due to the bias connection, as shown in "Recommended Application Circuit", Fig. 2
GND	2,4	Connections to ground. Use via holes as shown in "Suggested Layout for PCB Design" to reduce ground path inductance for best performance.





ULTRA FLAT GAIN, LOW NOISE

Monolithic Amplifier

PGA-105+

CHARACTERIZATION TEST CIRCUIT

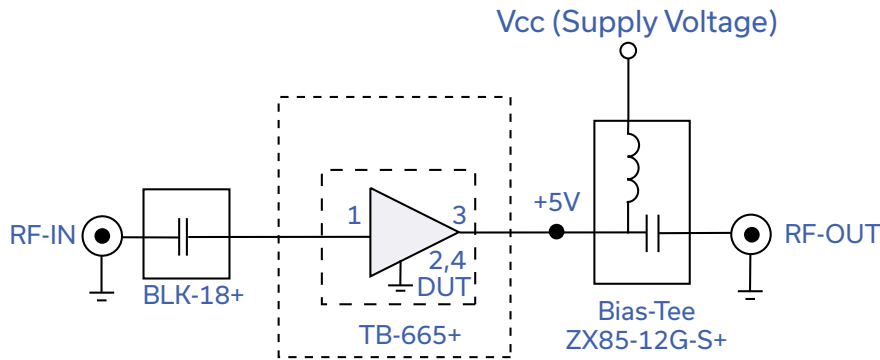
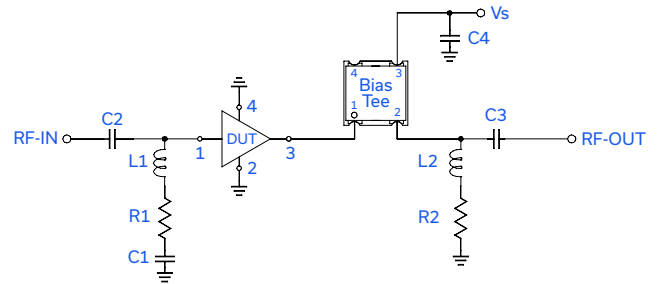
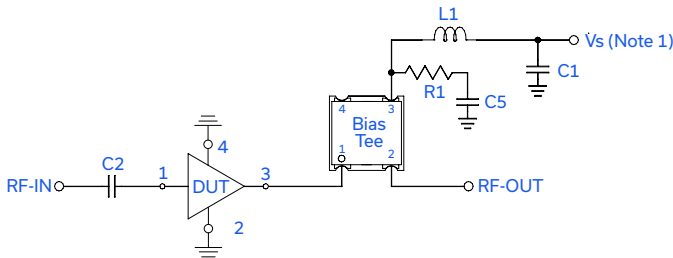

Fig 1. Block Diagram of Test Circuit used for characterization. (DUT tested on Mini-Circuits Characterization test board TB-665+) Gain, Return loss, Output power at 1dB compression (P1 dB), output IP3 (OIP3) and noise figure measured using Agilent's N5242A PNA-X microwave network analyzer.

Conditions:

1. Gain and Return loss: Pin= -25dBm
2. Output IP3 (OIP3): Two tones, spaced 1 MHz apart, 0 dBm/tone at output.

RECOMMENDED APPLICATION CIRCUITS



COMPONENT	VALUE	SIZE	PART NUMBER	MANUFACTURER
DUT		SOT-89	PGA-105+	Mini-Circuits
C1,C5	0.1 uF	0805	08055C104JAT2A	AVX
C2	0.001 pF	0402	GRM1555C1H102JA01D	AVX
R1	33.2 Ohm	0805	RK73H2ATTD33R2F	KOA Speer Electronics
L1	43 nH	0805	0805CS-430XGLC	Coilcraft, Inc
BIAS TEE			TCBT-14+	Mini-Circuits

Fig 2. Evaluation board TB-678-105+ includes case, connectors, and components soldered to PCB

COMPONENT	VALUE	SIZE	PART NUMBER	MANUFACTURER
DUT		SOT-89	PGA-105+	Mini-Circuits
C1	4700 pF	0402	GRM155R71H472JA01D	Murata Electronics N.A.
C2,C3	2200 pF	0402	GRM155R71H222JA01D	Murata Electronics N.A.
C4	0.1 uF	0805	08055C104JAT2A	AVX
R1	14 Ohm	0402	RK73H1ETTP14R0F	KOA Speer Electronics
R2	49.9 Ohm	0402	RK73H1ETTP49R9F	KOA Speer Electronics
L1	390 nH	0805	0805CS-391XGLC	Coilcraft, Inc
L2	330 nH	0806	0805CS-331XGLC	Coilcraft, Inc
BIAS TEE			TCBT-14+	Mini-Circuits

Fig 3. Evaluation board TB-733-105+ with unconditional stability (see applications note AN-60-063)

PRODUCT MARKING

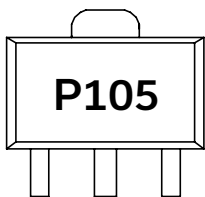

Marking may contain other features or characters for internal lot control





ULTRA FLAT GAIN, LOW NOISE

Monolithic Amplifier

PGA-105+

Mini-Circuits

ADDITIONAL DETAILED TECHNICAL INFORMATION IS AVAILABLE ON OUR DASH BOARD. TO ACCESS [CLICK HERE](#)

Performance Data	Data Table
	Swept Graphs
	S-Parameter (S2P Files) Data Set (.zip file)
Case Style	DF782 (SOT 89) Plastic package, exposed paddle lead finish: Matte-Tin
Tape & Reel Standard quantities available on reel	F55 7" reels with 20, 50, 100, 200, 500 or 1K devices
Suggested Layout for PCB Design	PL-370
Evaluation Board	TB-678-105+ TB-733-105+ (See application note: AN-60-063)
Environmental Ratings	ENV08T1

ESD RATING

Human Body Model (HBM): Class 1A (250 to <500V) in accordance with ANSI/ESD STM 5.1 - 2001

Machine Model (MM): Class M1(pass 25V) in accordance with ANSI/ESD STM5.2-1999

MSL RATING

Moisture Sensitivity: MSL1 in accordance with IPC/JEDEC J-STD-020D

MSL TEST FLOW CHART

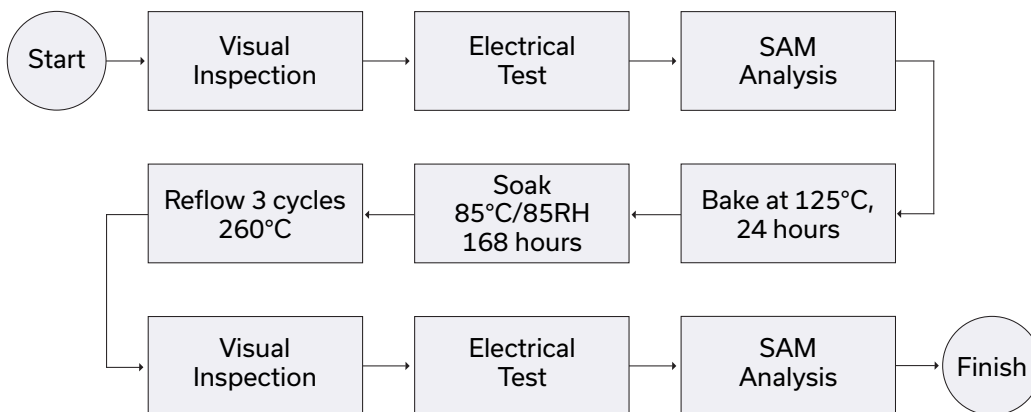

- NOTES**
- A. Performance and quality attributes and conditions not expressly stated in this specification document are intended to be excluded and do not form a part of this specification document.
 - B. Electrical specifications and performance data contained in this specification document are based on Mini-Circuit's applicable established test performance criteria and measurement instructions.
 - C. The parts covered by this specification document are subject to Mini-Circuits standard limited warranty and terms and conditions (collectively, "Standard Terms"); Purchasers of this part are entitled to the rights and benefits contained therein. For a full statement of the standard. Terms and the exclusive rights and remedies thereunder, please visit Mini-Circuits' website at www.minicircuits.com/MCLStore/terms.jsp

