

Video / Audio Interfaces for TV and DVD Recorders



NTSC-PAL Audio I/O Interface for Recording BD3823FV

•Description

BD3823FV is a low-noise (3.2 μ Vrms), low distortion (0.0015%), 5ch selector, incorporating a resistor-ladder type volume.

Because of a wide power supply voltage range (7V to 14.5V), BD3823FV can meet a wide input voltage (to 4.5 Vrms), and high S/N can be achieved. In addition, the built-in volume does not add any distortion ratio characteristics, even when the attenuation is varied, and is applicable for high-quality audio systems.

•Features

- 1) A resistor-ladder type volume circuit is with a low distortion ratio (0.0015% with volume set to -6dB) and low noise (3.2 μ Vrms with volume set to -6dB).
- 2) By grouping sound input terminals with output terminals, the PCB layout is reduced.
- 3) Small package SSOP - B20 achieves good crosstalk characteristics (-110 dB).
- 4) The use of Bi-CMOS process enables low current consumption and energy saving design.
Because of low current consumption, BD3823FV has the advantage in quality over the scaling down of the internal regulators and heat controls.

•Applications

DVD recorders

•Absolute maximum rating (Ta=25°C)

Parameter	Symbol	Limits	Unit
Applied Voltage	VCC	15.0	V
	SCL, SDA	7.0	
Input voltage	VIN	VCC+0.3~GND-0.3	V
Power Dissipation	Pd	810 ^{*1}	mW
Operating Temperature	Topr	-40~+85 ^{*2}	°C
Storage Temperature	Tastg	-55~+150	°C

*1 Reduced by 6.5 mW/°C at 25°C or higher.

Thermal resistance $\theta_{ja} = 154$ (°C/W), when Rohm standard board is mounted.

Rohm standard board: Size: 70×70×1.6 (mm³)

Material: FR4 glass-epoxy substrate (copper foil area: not more than 3%).

*2 As long as voltage stays within operating voltage range, certain circuit operation is guaranteed in the operating temperature range.

Allowable power loss conditions are related to temperature, to which care must be taken.

In addition though the standard value of its electrical characteristics cannot be guaranteed under the conditions other than those specified, basic functions are maintained.

•Operating range (Basic operation at Ta=25°C)

Parameter	Symbol	Min.	Typ.	Max.	Unit
Power supply voltage ^{*3}	VCC	7.0	12.0	14.5	V

*3 As long as temperature and operating voltage meet specifications

In addition, though the standard value of its electrical characteristics cannot be guaranteed under the conditions other than those specified, basic functions are maintained.

●Electrical characteristics

Unless otherwise specified, Ta=25°C, VCC=12V, f=1kHz, Vin=1Vrms, Rg=600Ω, RL=10kΩ, Gain selector = 0dB, Volume = 0dB, Input terminal = Front 1, Output terminal = Out 1

	Parameter	Symbol	Limits			Unit	Conditions
			Min.	Typ.	Max.		
GENERAL	Circuit Current upon no signal	I _Q	-	2.5	10	mA	V _{IN} =0Vrms
	Voltage gain	G _V	-1.5	0	1.5	dB	G _V =20log(V _{OUT} /V _{IN})
	Maximum output voltage	V _{OM}	3.0	3.6	-	Vrms	V _{OM} at THD(V _{OUT})=1% BW=400Hz-30KHz.
	Channel balance	CB	-1.5	0	1.5	dB	CB = G _{V1} -G _{V2} G _{V1} :ch1Gain, G _{V2} :ch2 Gain
	Total harmonic distortion	THD	-	0.0015	0.05	%	V _{IN} =2Vrms, Volume=-6dB BW=400Hz-30KHz
	Output noise voltage *	V _{NO}	-	3.2	16	μVrms	Volume=-6dB R _g = 0Ω, BW=IHF-A
	Residual output noise voltage *	V _{NOR}	-	2	10	μVrms	Volume = -∞dB R _g = 0Ω, BW=IHF-A
	Cross-talk between channels *	CTC	-	-110	-80	dB	R _g = 0Ω BW = IHF-A
	Input impedance	R _{IN}	77	110	143	kΩ	1pin-10pin terminal
	Maximum input voltage	V _{IM}	3.1	3.6 ¹⁾	-	Vrms	V _{IM} at THD(V _{OUT})=1% BW=400Hz-30KHz 1pin-10pin terminal
	Cross-talk between selectors *	CTS	-	-110	-80	dB	R _g = 0Ω BW = IHF-A CTS=20log(V _{OUT} /V _{IN})
VOLUME	Volume control range	V _V	-32.5	-30.5	-28.5	dB	G _V =20log(V _{OUT} /V _{IN}) BW = IHF-A
	Maximum attenuation *	G _{V MIN}	-	-106	-85	dB	Volume = -∞dB G _V =20log(V _{OUT} /V _{IN}) BW = IHF-A
	Step resolution	G _{V STEP}	-	0.5	-	dB	Volume=0~-30.5dB
	Attenuation set error	G _{V ERR}	-1.5	0	1.5	dB	Volume=0~-30.5dB
GAIN SELECTOR	Maximum gain	G _{MAX}	4.5	6	7.5	dB	Gain Selector=6dB V _{IN} =500mVrms G=20log(V _{OUT} /V _{IN})
	Step resolution	G _{STEP}	-	2	-	dB	From 2dB to 4dB
	Gain set error	G _{ERR}	-1.5	0	1.5	dB	

* VP-9690A (average value detection, effective value display) filter by Matsushita Communication is used for * measurement.

* Phase between input/output is the same.

* This IC is not designed to be radiation-resistant.

1) V_{IM}=2.5Vrms(TYP) at VCC=9V, THD(V_{OUT})=1%
V_{IN}=4.2Vrms(TYP) at VCC=14V, THD(V_{OUT})=1%

•Timing chart

Electrical specifications and timing of bus lines and I/O stages

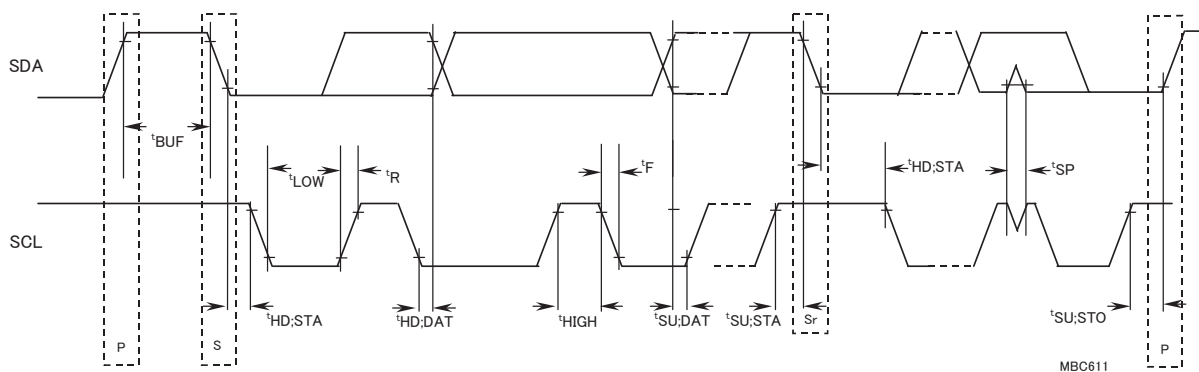

Fig.1 Timing Definition on I²C BUS

Table 1. Characteristics of the SDA and SCL BUS lines for I²C BUS devices

Parameter	Symbol	High speed mode I ² C BUS		Unit
		Min.	Max.	
1 SCL clock frequency	fSCL	0	400	kHz
2 Bus free time between a STOP and START condition	tBUF	1.3	-	μs
3 Hold time (repeated) START condition. After this period, the first clock pulse is generated	tHD;STA	0.6	-	μs
4 LOW period of the SCL clock	tLOW	1.3	-	μs
5 HIGH period of the SCL clock	tHIGH	0.6	-	μs
6 Set-up time for a repeated START condition	tSU;STA	0.6	-	μs
7 Data hold time	tHD;DAT	0*	-	μs
8 Data set-up time	tSU;DAT	100	-	ns
9 Rise time of both SDA and SCL signals	tR	20+C _b	300	ns
10 Fall time of both SDA and SCL signals	tF	20+C _b	300	ns
11 Set-up time for STOP condition	tSU;STO	0.6	-	μs
12 Capacitive load for each bus line	C _b	-	400	pF

The above numerical values all correspond to V_{IH min} and V_{IL max} levels (see Table 2).

*The input signals must internally provide at least 300 ns hold-time for SDA signals (at V_{IH min} of SCL signals) in order to cross over undefined region at the fall-end of SCL.

Table 2. Characteristics of the SDA and SCL I/O stages for I²C BUS devices

Parameter	Symbol	High speed mode I ² C BUS		Unit
		Min.	Max.	
13 Low-level input voltage : fixed input levels	V _L	-0.5	1.0	V
14 High-level input voltage : fixed input levels	V _H	2.3	-	μs
15 Hysteresis of Schmitt trigger inputs: fixed input levels	V _{hys}	n/a	n/a	V
16 Pulse width of spikes which must be suppressed by the input filter.	t _{SP}	0	50	ns
17 Low-level output voltage (open drain): at 3mA sink current	V _{OL1}	0	0.4	V
18 Output fall time from V _{IHmin} . to V _{IHmax} . with a bus capacitance from 10 pF to 400pF: with up to 3mA sink current at V _{OL1}	t _{oF}	20+0.1C _b	250	ns
19 Input current each I/O pin with an input voltage between 0.4V and 0.9 V _{CCmax} .	I _i	-10	10	μA
20 Capacitance for each I/O pin	C _i	-	10	pF

n/a = not applicable

I²C BUS FORMAT

MSB	LSB	MSB	LSB	MSB	LSB		
S	Slave Address	A	Select Address	A	Data	A	P
1bit	8bit	1bit	8bit	1bit	8bit	1bit	1bit

- S = Start condition (Recognition of start bit)
 Slave Address = Recognition of slave address. 7 bits in upper order are voluntary.
 Least significant bit is "L" for writing.
 A = ACKNOWLEDGE bit (Recognition of acknowledgement)
 Select Address = Selection of volume, etc.
 Data = Data such as volume, etc.
 P = Stop condition (Recognition of stop bit)

I²C BUS Interface Protocol

1) Basic form

S	Slave Address	A	Select Address	A	Data	A	P
MSB	LSB	MSB	LSB	MSB	LSB		

2) Automatic increment (Select Address increases (+1) according to the number of data.)

S	Slave Address	A	Select Address	A	Data1	A	Data2	A	...	DataN	A	P
MSB	LSB	MSB	LSB	MSB	LSB	MSB	LSB	MSB	LSB	MSB	LSB	

- (例) [1] Data 1 shall be set as data of address specified by Select Address.
 [2] Data 2 shall be set as data of address specified by Select Address +1.
 [3] Data N shall be set as data of address specified by Select Address +N-1.

Slave Address

Because the slave address can be changed by the SELECT setting, it is possible to use two chips simultaneously on a single control BUS .

	MSB							LSB
SELECT voltage condition	A6	A5	A4	A3	A2	A1	A0	R/W
GND ~ 0.2×VCC	1	0	0	0	0	0	0	0
0.8×VCC ~ VCC	1	0	0	0	0	1	0	0

Set the SELECT voltage within the condition defined.

Data format

Items to be set	Select Address (HEX)	Data							LSB
		D7	D6	D5	D4	D3	D2	D1	
Input Selector	00	*	*	*	*	*	Input Selector		
Volume ch1	01	*	*	Volume attenuation ch1					
Volume ch2	02	*	*	Volume attenuation ch2					
Gain Selector	03	*	*	*	*	*	*	Gain Selector	

*Don't care

●Application circuit diagram

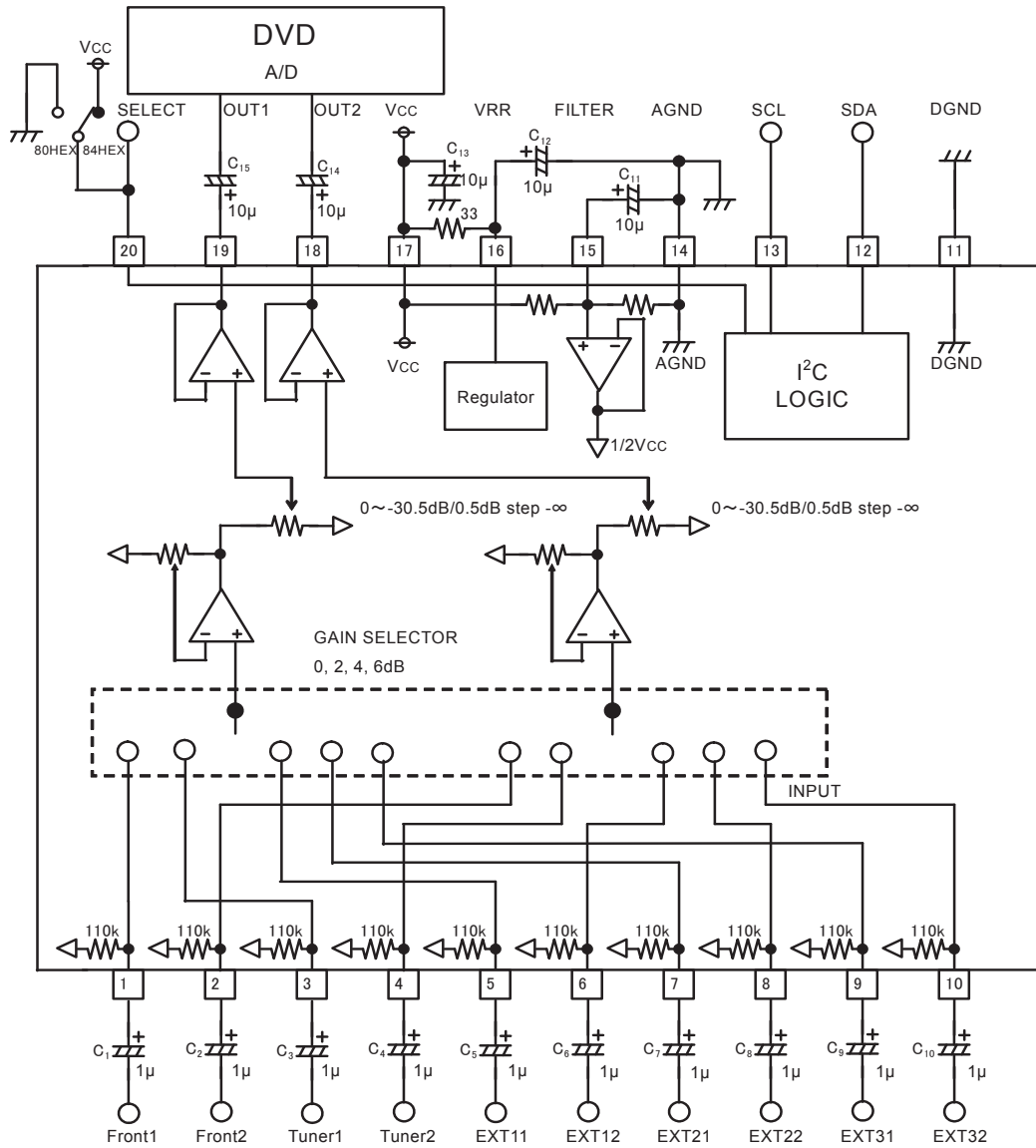

Fig.2 Application Circuit Diagram

Pin No.	Pin Name	Pin Description	Pin No.	Pin Name	Pin Description
1	Front1	Front 1ch input terminal	11	DGND	Ground terminal
2	Front2	Front 2ch input terminal	12	SDA	I ² C communication data terminal
3	Tuner1	Tuner 1 ch input	13	SCL	I ² C communication clock terminal
4	Tuner2	Tuner 2 ch input	14	AGND	Ground terminal
5	EXT11	External 1 1ch input terminal	15	FILTER	1/2Vcc terminal
6	EXT12	External 1 2ch input terminal	16	VRR	Ripple filter terminal
7	EXT21	External 2 1ch input terminal	17	Vcc	Power supply terminal
8	EXT22	External 2 2ch input terminal	18	OUT2	Volume 2ch output terminal
9	EXT31	External 3 1ch input terminal	19	OUT1	Volume 1ch output terminal
10	EXT32	External 3 2ch input terminal	20	SELECT	Slave address selection terminal

●Reference data

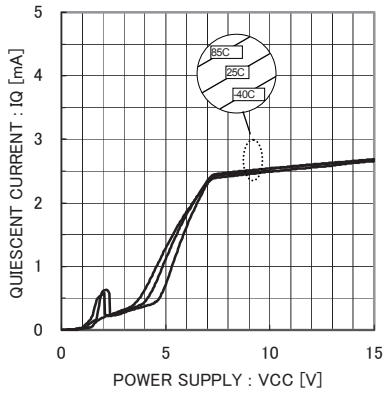

Fig.3 Quiescent Current vs. Power Supply

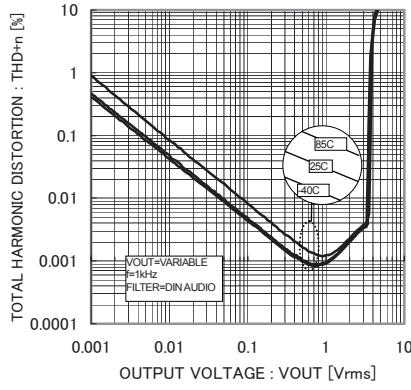

Fig.4 Total harmonic distortion vs. Output Voltage

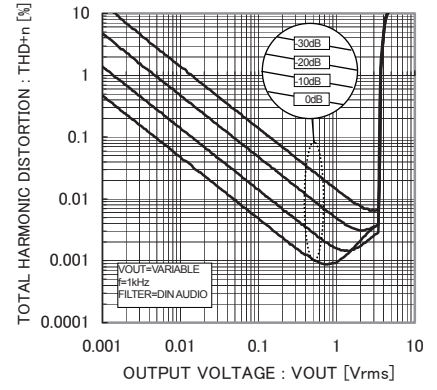

Fig.5 Total harmonic distortion vs. Output voltage

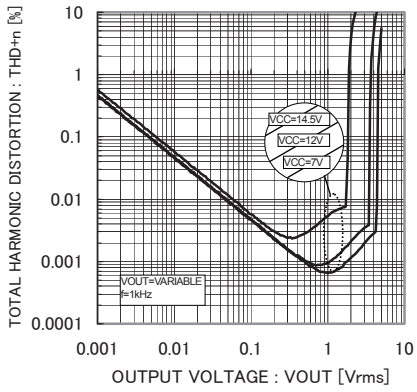

Fig.6 Total harmonic distortion vs. Output voltage

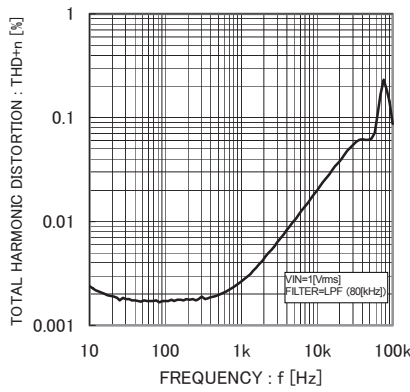

Fig.7 Total harmonic distortion vs. Frequency

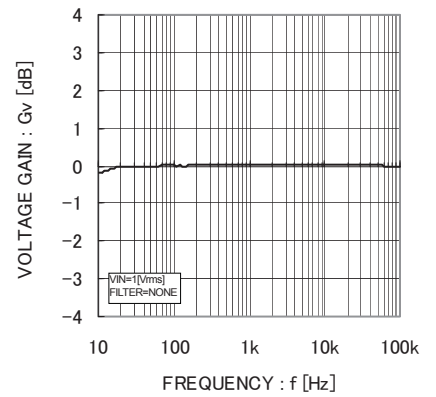

Fig.8 Voltage gain vs. Frequency

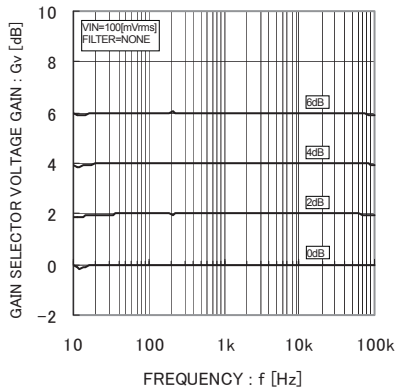

Fig.9 Gain selector voltage gain vs. Frequency

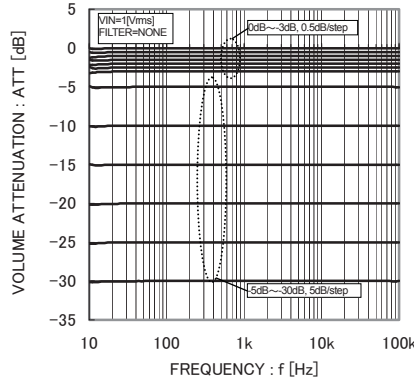

Fig.10 Volume attenuation vs. Frequency

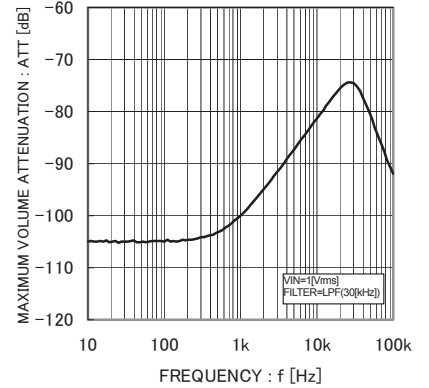

Fig.11 Maximum volume attenuation vs. Frequency

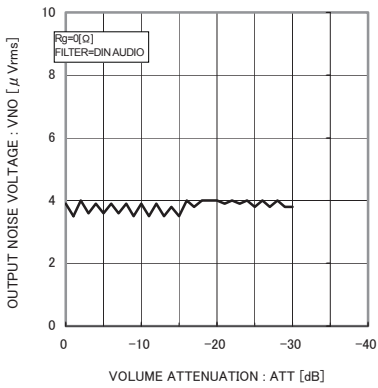

Fig.12 Volume attenuation vs. voltage attenuation

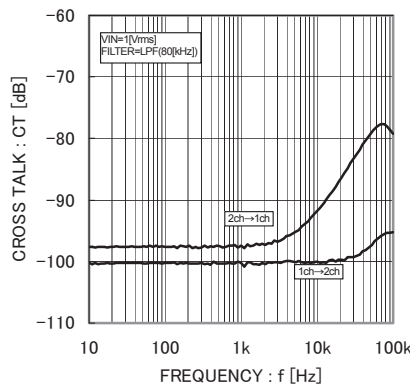

Fig.13 Cross Talk vs. Frequency

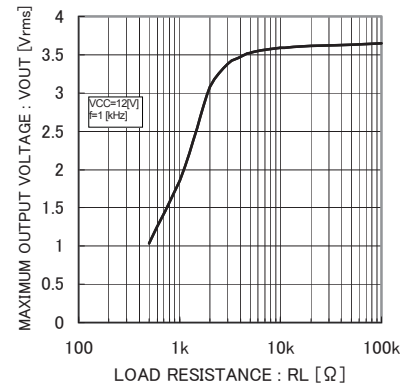

Fig.14 Maximum output voltage vs. Load resistance

●How to select application parts

Initial condition when power supply (17 pin) is turned ON

A circuit that carries out initialization in IC, when power supply (17 pin) is turned ON is incorporated. Settings are as shown in the following table. However, it is recommended to transmit the data to all the addresses as initial data when power is turned ON, and to apply mute while the initial data is input

Parameter	Symbol	Limits			Unit	Conditions
		Min.	Typ.	Max.		
VCC rise time	Trise	20	-	-	μS	VCC rise time from 0V to 3V
VCC voltage when power on reset is released.	Vpor	-	2.6	-	V	

Function	Initial Condition
Input Selector	Input MUTE
Volume	-∞dB
Gain SERECTOR	0dB

Signal input section

1) Setting for input coupling capacitor

In the signal input terminal, set the constant for the input coupling capacitor C(F), taking the input impedance R_{IN} (Ω) inside into account. This makes up the primary HPF characteristics of the RC.

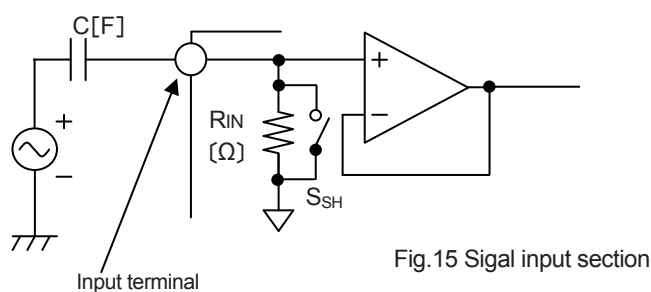
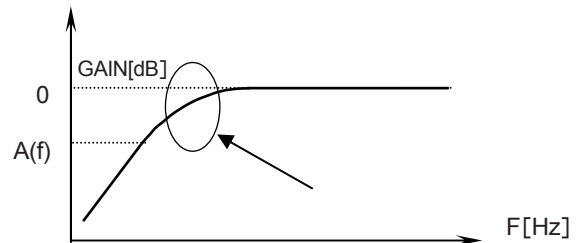

Fig.15 Signal input section



2) SHORT mode of input

SHORT mode is a command to reduce resistance by setting impedance R_{IN} to switch S_{SH} =ON. When SHORT command is not chosen, switch S_{SH} is turned OFF. By using this command, it is possible to stop charging externally mounted coupling capacitor C. Use SHORT mode when there is no signal since the SHORT mode turns ON the S_{SH} switch in order to achieve low impedance.

● Operation Notes

1. Numbers and data in entries are representative design values and are not guaranteed values of the items.
2. Although ROHM is confident that the example application circuit reflects the best possible recommendations, be sure to verify circuit characteristics for your particular application. Modification of constants for other externally connected circuits may cause variations in both static and transient characteristics for external components as well as this Rohm IC. Allow for sufficient margins when determining circuit constants.
3. Absolute maximum ratings
Use of the IC in excess of absolute maximum ratings, such as the applied voltage or operating temperature range (T_{opr}), may result in IC damage. Assumptions should not be made regarding the state of the IC (short mode or open mode) when such damage is suffered. A physical safety measure, such as a fuse, should be implemented when using the IC at times where the absolute maximum ratings may be exceeded.
4. GND potential
Ensure a minimum GND pin potential in all operating conditions. Make sure that no pins are at a voltage below the GND at any time, regardless of whether it is a transient signal or not.
5. Thermal design
Perform thermal design, in which there are adequate margins, by taking into account the permissible dissipation (Pd) in actual states of use.
6. Short circuit between terminals and erroneous mounting
Pay attention to the assembly direction of the ICs. Wrong mounting direction or shorts between terminals, GND, or other components on the circuits, can damage the IC.
7. Operation in strong electromagnetic field
Using the ICs in a strong electromagnetic field can cause operation malfunction.

● Selection of order type

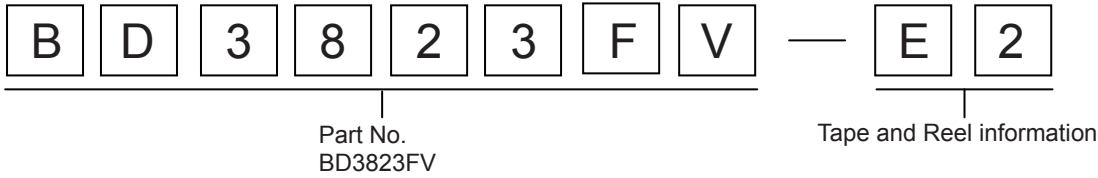

SSOP-B20

<Dimension>

(Unit:mm)

<Tape and Reel information>

Tape	Embossed carrier tape
Quantity	2500pcs
Direction of feed	E2 (Correct direction: 1pin of product should be at the upper left when you hold reel on the left hand, and you pull out the tape on the right hand)

※Orders are available in complete units only.

- The contents described herein are correct as of October, 2005
- The contents described herein are subject to change without notice. For updates of the latest information, please contact and confirm with ROHM CO.,LTD.
- Any part of this application note must not be duplicated or copied without our permission.
- Application circuit diagrams and circuit constants contained herein are shown as examples of standard use and operation. Please pay careful attention to the peripheral conditions when designing circuits and deciding upon circuit constants in the set.
- Any data, including, but not limited to application circuit diagrams and information, described herein are intended only as illustrations of such devices and not as the specifications for such devices. ROHM CO.,LTD. disclaims any warranty that any use of such devices shall be free from infringement of any third party's intellectual property rights or other proprietary rights, and further, assumes no liability of whatsoever nature in the event of any such infringement, or arising from or connected with or related to the use of such devices.
- Upon the sale of any such devices, other than for buyer's right to use such devices itself, resell or otherwise dispose of the same, implied right or license to practice or commercially exploit any intellectual property rights or other proprietary rights owned or controlled by ROHM CO., LTD. is granted to any such buyer.
- The products described herein utilize silicon as the main material.
- The products described herein are not designed to be X ray proof.

The products listed in this catalog are designed to be used with ordinary electronic equipment or devices (such as audio visual equipment, office-automation equipment, communications devices, electrical appliances and electronic toys). Should you intend to use these products with equipment or devices which require an extremely high level of reliability and the malfunction of which would directly endanger human life (such as medical instruments, transportation equipment, aerospace machinery, nuclear-reactor controllers, fuel controllers and other safety devices), please be sure to consult with our sales representative in advance.

Excellence in Electronics



ROHM CO., LTD.

21, Saiin Mizosaki-cho, Ukyo-ku, Kyoto
615-8585, Japan
TEL: (075)311-2121 FAX: (075)315-0172
URL <http://www.rohm.com>

Published by
Application Engineering Group

Contact us for further information about the products.

- Atlanta U.S.A. / ROHM ELECTRONICS ATLANTA SALES OFFICE
(DIVISION OF ROHM ELE.U.S.A.,LLC)
TEL:+1(770)754-8972 FAX:+1(770)754-0391
- Dallas U.S.A. / ROHM ELECTRONICS DALLAS SALES OFFICE
(DIVISION OF ROHM ELE.U.S.A.,LLC)
TEL:+1(972)312-8818 FAX:+1(972)312-0330
- San Diego U.S.A. / ROHM ELECTRONICS SAN DIEGO SALES OFFICE
(DIVISION OF ROHM ELE.U.S.A.,LLC)
TEL:+1(619)425-3630 FAX:+1(619)425-3670
- Germany / ROHM ELECTRONICS GMBH (GERMANY)
TEL:+49(2154)9210 FAX:+49(2154)921400
- United Kingdom / ROHM ELECTRONICS GMBH (UK)
TEL:+44(0)1908-306700 FAX:+44(0)1908-235788
- France / ROHM ELECTRONICS GMBH (FRANCE)
TEL:+33(0)1 56 97 30 60 FAX:+33(0)1 56 97 30 80
- Hong Kong China / ROHM ELECTRONICS (H.K.) CO., LTD.
TEL:+852(2)7406262 FAX:+852(2)375-8971
- Shanghai China / ROHM ELECTRONICS (SHANGHAI) CO., LTD.
TEL:+86(21)6273-2727 FAX:+86(21)6247-2066
- Dalian China / ROHM ELECTRONICS TRADING (DALIAN) CO., LTD.
TEL:+86(411)8230-8549 FAX:+86(411)8230-8537

- Beijing China / BEIJING REPRESENTATIVE OFFICE
TEL:+86(10)8525-2493 FAX:+86(10)8525-2499
- Taiwan / ROHM ELECTRONICS TAIWAN CO., LTD.
TEL:+886(2)2500-6956 FAX:+886(2)2503-2869
- Korea / ROHM ELECTRONICS KOREA CORPORATION
TEL:+82(2)8182-7000 FAX:+82(2)8182-7115
- Singapore / ROHM ELECTRONICS ASIA PTE.LTD. (RES/REI)
TEL:+65-6332-2322 FAX:+65-6332-6862
- Malaysia / ROHM ELECTRONICS (MALAYSIA) SDN. BHD.
TEL:+60(3)7958-8355 FAX:+60(3)7958-8377
- Philippines / ROHM ELECTRONICS (PHILIPPINES) SALES CORPORATION
TEL:+63(2)807-6872 FAX:+63(2)809-1422
- Thailand / ROHM ELECTRONICS (THAILAND) CO., LTD.
TEL:+66(2)254-4830 FAX:+66(2)256-6334

Notes

- No technical content pages of this document may be reproduced in any form or transmitted by any means without prior permission of ROHM CO.,LTD.
- The contents described herein are subject to change without notice. The specifications for the product described in this document are for reference only. Upon actual use, therefore, please request that specifications to be separately delivered.
- Application circuit diagrams and circuit constants contained herein are shown as examples of standard use and operation. Please pay careful attention to the peripheral conditions when designing circuits and deciding upon circuit constants in the set.
- Any data, including, but not limited to application circuit diagrams information, described herein are intended only as illustrations of such devices and not as the specifications for such devices. ROHM CO.,LTD. disclaims any warranty that any use of such devices shall be free from infringement of any third party's intellectual property rights or other proprietary rights, and further, assumes no liability of whatsoever nature in the event of any such infringement, or arising from or connected with or related to the use of such devices.
- Upon the sale of any such devices, other than for buyer's right to use such devices itself, resell or otherwise dispose of the same, no express or implied right or license to practice or commercially exploit any intellectual property rights or other proprietary rights owned or controlled by
- ROHM CO., LTD. is granted to any such buyer.
- Products listed in this document are no antiradiation design.

The products listed in this document are designed to be used with ordinary electronic equipment or devices (such as audio visual equipment, office-automation equipment, communications devices, electrical appliances and electronic toys).

Should you intend to use these products with equipment or devices which require an extremely high level of reliability and the malfunction of which would directly endanger human life (such as medical instruments, transportation equipment, aerospace machinery, nuclear-reactor controllers, fuel controllers and other safety devices), please be sure to consult with our sales representative in advance.

It is our top priority to supply products with the utmost quality and reliability. However, there is always a chance of failure due to unexpected factors. Therefore, please take into account the derating characteristics and allow for sufficient safety features, such as extra margin, anti-flammability, and fail-safe measures when designing in order to prevent possible accidents that may result in bodily harm or fire caused by component failure. ROHM cannot be held responsible for any damages arising from the use of the products under conditions out of the range of the specifications or due to non-compliance with the NOTES specified in this catalog.

Thank you for your accessing to ROHM product informations.

More detail product informations and catalogs are available, please contact your nearest sales office.

ROHM Customer Support System

THE AMERICAS / EUROPE / ASIA / JAPAN

www.rohm.com

Contact us : webmaster@rohm.co.jp