

DO NOT SCALE FROM THIS PRINT

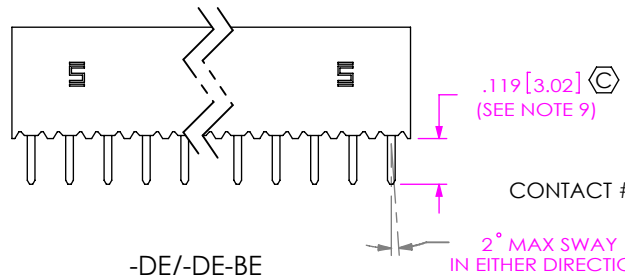

-DE/-DE-BE
FIG 1(SEE NOTE 11)

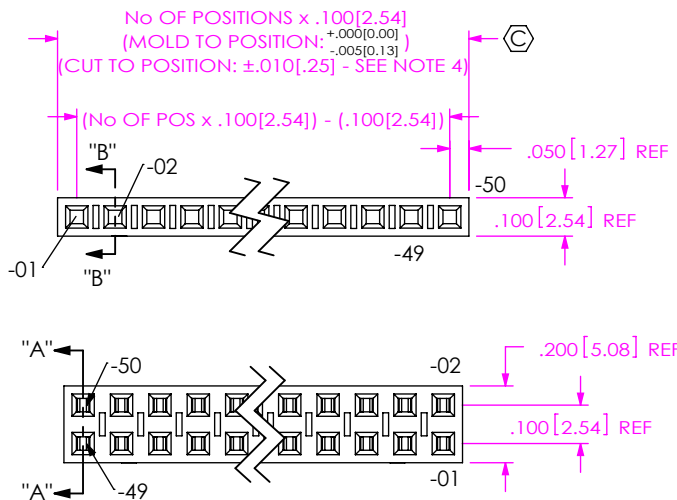
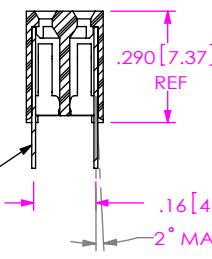

SECTION "A"-"A"
BCS-1XX-X-D-DE

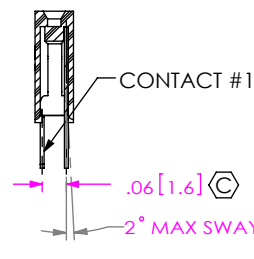

SECTION "B"-"B"
BCS-1XX-X-S-DE

No. OF POSITIONS
-01 THRU -50

PLATING SPECIFICATIONS
(SEE TABLE 1)

- T: MATTE TIN CONTACT AND TAIL
- L: 10μ" LIGHT SELECTIVE GOLD IN CONTACT AREA, MATTE TIN ON TAIL
- F: 3μ" FLASH SELECTIVE GOLD CONTACT AREA, MATTE TIN ON TAIL
- S: 30μ" SELECTIVE GOLD IN CONTACT AREA, MATTE TIN ON TAIL
- H: 30μ" HEAVY GOLD IN CONTACT AREA, 3μ" GOLD ON TAIL
- SM: 30μ" SELECTIVE GOLD IN CONTACT AREA, MATTE TIN ON TAIL
- TM: MATTE TIN CONTACT AND TAIL
- LM: 10μ" LIGHT SELECTIVE GOLD IN CONTACT AREA, MATTE TIN ON TAIL
- FM: 3μ" FLASH SELECTIVE GOLD IN CONTACT AREA, MATTE TIN ON TAIL
- LTL: 10μ" LIGHT SELECTIVE GOLD IN CONTACT AREA, TIN LEAD (90/10 +/-5%) ON TAIL

POLARIZING OPTION
INSERT PK-06-N INTO SPECIFIED POS AND BREAK OFF TAB (NOT AVAILABLE FOR -BE OPTION)

ENTRY SPECIFICATION

- DE: DUAL ENTRY (SEE TABLE 1)
- TE: TOP ENTRY (SEE TABLE 1)
- HE: HORIZONTAL ENTRY (SEE TABLE 1)
- PE: PASS-THROUGH ENTRY (SEE TABLE 1)
- DE-BE: (SEE TABLE 1)
- PE-BE: (SEE TABLE 1)

BODY SPECIFICATION

- S: SINGLE ROW (SEE TABLE 1)
- D: DOUBLE ROW (SEE TABLE 1)

TABLE 1			
ENTRY SPEC	BODY SPEC	CONTACT #1	CONTACT #2
-S-DE (SEE FIG 1)	SSM-XX-S	C-95-01-X	-----
-D-DE (SEE FIG 1)	SSM-XX-D	C-95-01-X	-----
-S-TE (SEE FIG 3)	SSM-XX-S	C-95-09-X	-----
-D-TE (SEE FIG 3)	SSM-XX-D	C-95-09-XXX	-----
-S-HE (SEE FIG 2)	BCH-XX-S	C-58-05-X	-----
-D-HE (SEE FIG 2)	BCH-XX-D	C-58-04-X	C-58-03-X
-S-PE (SEE FIG 4)	SSM-XX-S	C-166-10-X	-----
-D-PE (SEE FIG 4)	SSM-XX-D	C-166-10-X	-----
-S-DE-BE (SEE FIG 1)	SSM-XX-S-BE	C-95-01-X	-----
-D-DE-BE (SEE FIG 1)	SSM-XX-D	C-95-01-X	-----
-S-PE-BE (SEE FIG 4)	SSM-XX-S-BE	C-166-10-X	-----
-D-PE-BE (SEE FIG 4)	SSM-XX-D	C-166-10-X	-----

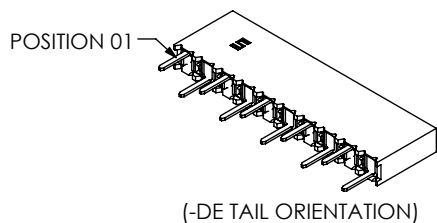

(-DE TAIL ORIENTATION)

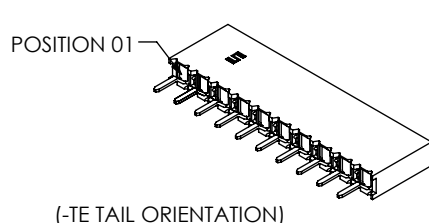

(-TE TAIL ORIENTATION)

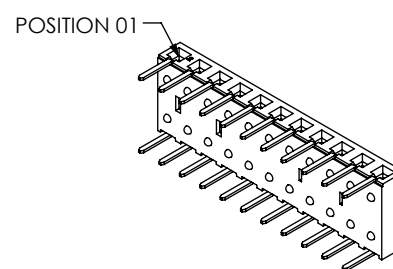

(-HE TAIL ORIENTATION)

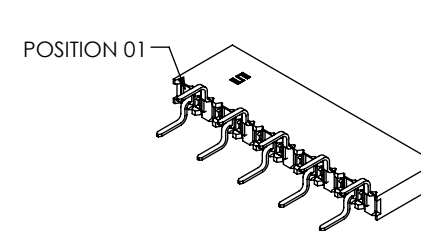

(-PE TAIL ORIENTATION)

NOTES:

1. Ⓞ REPRESENTS CRITICAL DIM. FOR STATISTICAL PROCESS CONTROL.
2. MINIMUM PUSHOUT FORCE TO BE: 1 LB.
3. [] DIMENSIONS ARE IN MILLIMETERS.
4. MINIMUM WALL THICKNESS ON CUT PARTS: .009 [0.23].
5. CUT PARTS TO BE SYMMETRICAL ABOUT C.
6. 1st POSITION WILL ALWAYS POINT UP ON TOP VIEW AS SHOWN.
7. 1 THROUGH 4 POSITIONS ARE TO BE LAYER PACKAGED, 5 THROUGH 50 POSITIONS ARE TO BE TUBED FOR ALL ENTRY SPECIFICATION EXCEPT BCS-S-HE AND BCS-D-HE. FOR BCS-S-HE AND BCS-D-HE, 1 THROUGH 3 POSITIONS ARE TO BE LAYER PACKAGED, 4 THROUGH 50 POSITIONS ARE TO BE TUBED.
8. DAMAGE TO THE CUT SURFACE CAN NOT EFFECT LEAD-IN OF THE CORES.
9. MAXIMUM VARIATION WITHIN A ROW: .006 [0.15].
MAXIMUM VARIATION FROM ROW TO ROW: .012 [0.30].
10. MAXIMUM CUT FLASH: .015 [0.38].
11. CHAMFERED END-WALLS MAY OR MAY NOT BE PRESENT ON ONE OR BOTH ENDS OF FINISHED GOOD.

UNLESS OTHERWISE SPECIFIED, DIMENSIONS ARE IN INCHES.

TOLERANCES ARE:

DECIMALS ANGLES
.XX: ±.01[0.3] 2°
.XXX: ±.005[0.13]
.XXXX: ±.0020[0.051]

PROPRIETARY NOTE

THIS DOCUMENT CONTAINS CONFIDENTIAL AND PROPRIETARY INFORMATION AND ALL DESIGN, MANUFACTURING, REPRODUCTION, USE, PATENT RIGHTS AND SALES RIGHTS ARE EXPRESSLY RESERVED BY SAMTEC, INC. THIS DOCUMENT SHALL NOT BE DISCLOSED, IN WHOLE OR PART, TO ANY UNAUTHORIZED PERSON OR ENTITY NOR REPRODUCED, TRANSFERRED OR INCORPORATED IN ANY OTHER PROJECT IN ANY MANNER WITHOUT THE EXPRESS WRITTEN CONSENT OF SAMTEC, INC.

MATERIAL: DO NOT SCALE DRAWING SHEET SCALE: 2:1
INSULATOR: GLASS FILLED LCP UL 94 VO, COLOR: BLACK
CONTACT: PHOS. BRONZE



520 PARK EAST BLVD, NEW ALBANY, IN 47150
PHONE: 812-944-6733 FAX: 812-948-5047
e-Mail info@SAMTEC.com code 5332

DESCRIPTION: BOX CONNECTOR SOCKET STRIP
DWG. NO. BCS-1XX-XXX-X-XX-XXX
BY: KOLB 09/12/1991 SHEET 1 OF 3

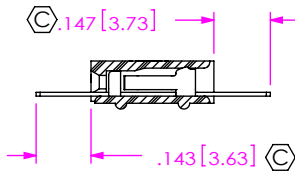
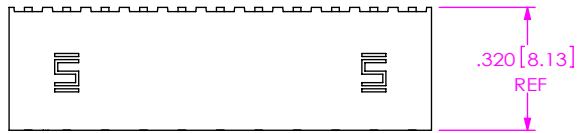

IN-PROCESS
-S-HE

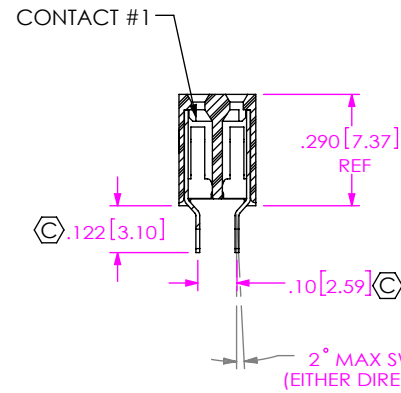

BCS-1XX-XXX-D-TE

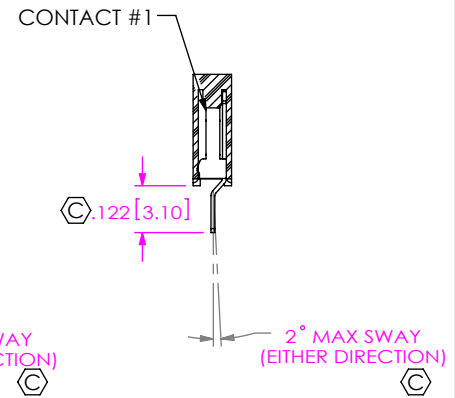

BCS-1XX-X-S-TE

FIG 3
-TE

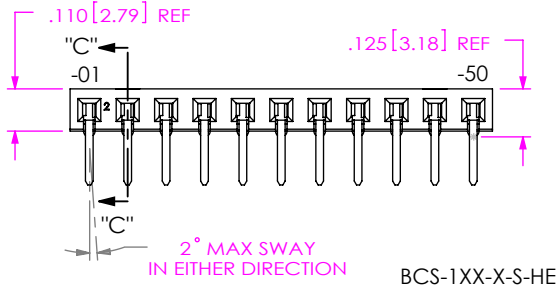

BCS-1XX-X-S-HE

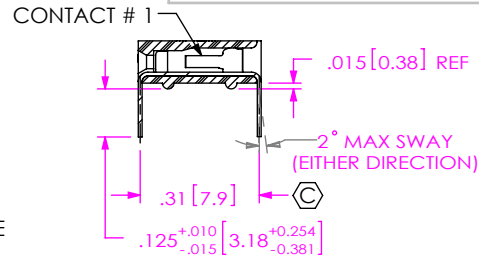

SECTION "C"- "C"

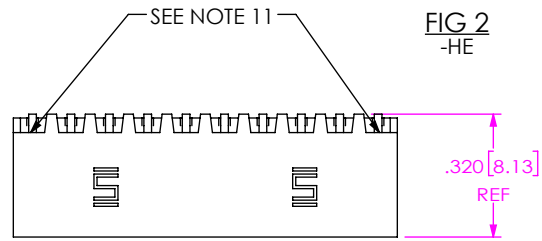
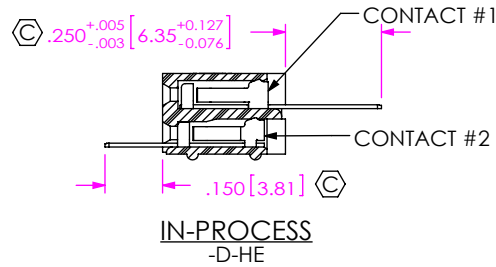
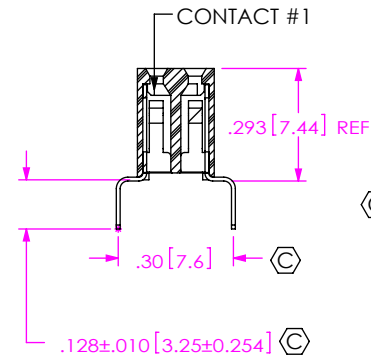

FIG 2
-HE



IN-PROCESS
-D-HE



BCS-1XX-XXX-D-PE

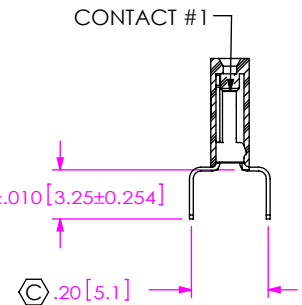

BCS-1XX-X-S-PE

FIG 4
-PE/-PE-BE
(SEE SHEET 3 FOR IN-PROCESS)

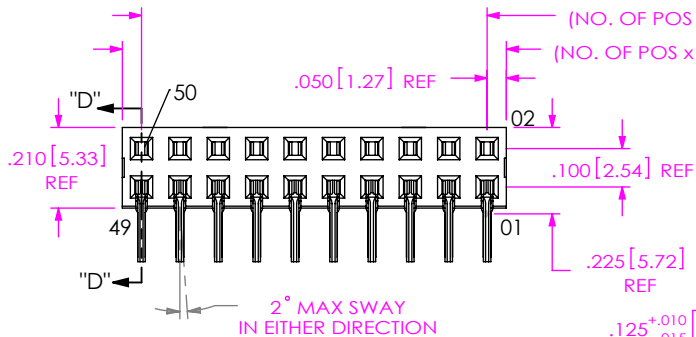

BCS-1XX-X-D-HE

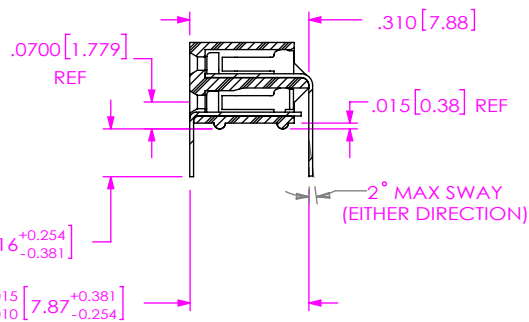

SECTION "D"- "D"

PROPRIETARY NOTE
THIS DOCUMENT CONTAINS CONFIDENTIAL AND PROPRIETARY INFORMATION AND ALL DESIGN, MANUFACTURING, REPRODUCTION, USE, PATENT RIGHTS AND SALES RIGHTS ARE EXPRESSLY RESERVED BY SAMTEC, INC. THIS DOCUMENT SHALL NOT BE DISCLOSED, IN WHOLE OR PART, TO ANY UNAUTHORIZED PERSON OR ENTITY NOR REPRODUCED, TRANSFERRED OR INCORPORATED IN ANY OTHER PROJECT IN ANY MANNER WITHOUT THE EXPRESS WRITTEN CONSENT OF SAMTEC, INC.

DO NOT SCALE DRAWING

SHEET SCALE: 2:1



520 PARK EAST BLVD, NEW ALBANY, IN 47150
PHONE: 812-944-6733 FAX: 812-948-5047
e-Mail info@SAMTEC.com code 55322

DESCRIPTION:	BOX CONNECTOR SOCKET STRIP
DWG. NO.	BCS-1XX-XXX-X-XX-XXX
BY:	KOLB 09/12/1991 SHEET 2 OF 3

IN-PROCESS 1

IN-PROCESS 2

IN-PROCESS 1

IN-PROCESS 2

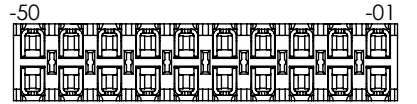
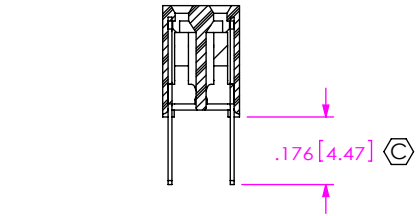

-S-BE: (SAME AS FIG 1 EXCEPT AS SHOWN)
-D-BE: (SAME AS FIG 1)

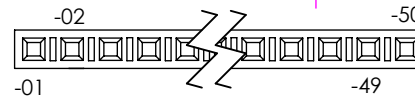
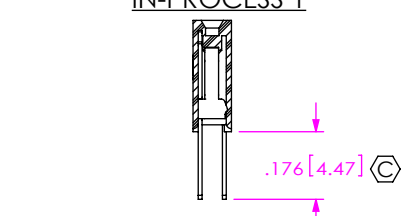
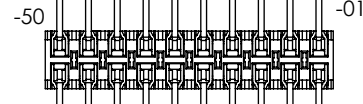
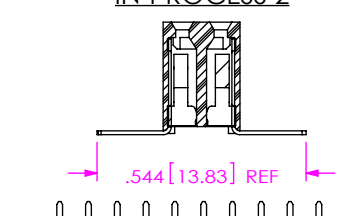

-S-PE-BE: (SAME AS -S-PE EXCEPT AS SHOWN)
-D-PE-BE: (SAME AS -D-PE)

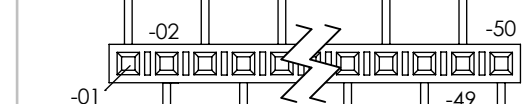
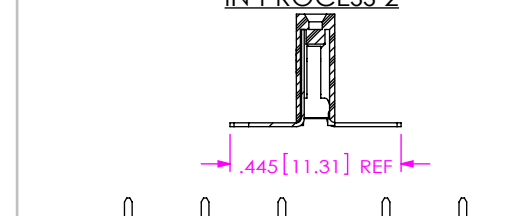

(SEE NOTE 6)

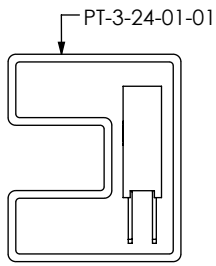

BCS-S-DE
BCS-S-DE-BE

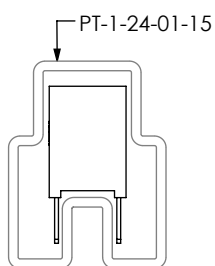

BCS-D-PE
BCS-D-PE
BCS-D-PE-BE
BCS-D-PE-DE-BE

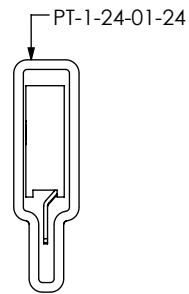

BCS-S-TE

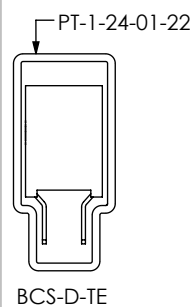

BCS-D-TE

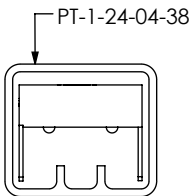

BCS-S-HE
(SEE NOTE 7)

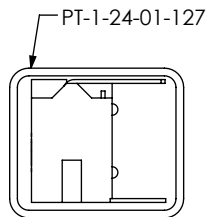

BCS-D-HE
(SEE NOTE 7)

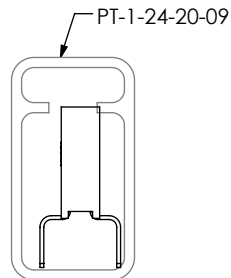

BCS-S-PE
BCS-S-PE-BE

PART NUMBER	TUBE	PLUG
BCS-S-DE	PT-3-24-01-01	TP-03 (2)
BCS-D-DE	PT-1-24-01-15	TP-03 (2)
BCS-S-TE	PT-1-24-01-24	TP-24 (2)
BCS-D-TE	PT-1-24-01-22	TP-03 (2)
BCS-S-HE	PT-1-24-04-38	TP-03 (2)
BCS-D-HE	PT-1-24-01-127	TP-03 (2)
BCS-S-PE	PT-1-24-20-09	TP-03 (2)
BCS-D-PE	PT-1-24-01-15	TP-03 (2)
BCS-S-DE-BE	PT-3-24-01-01	TP-03 (2)
BCS-D-DE-BE	PT-1-24-01-15	TP-03 (2)
BCS-S-PE-BE	PT-1-24-20-09	TP-03 (2)
BCS-D-PE-BE	PT-1-24-01-15	TP-03 (2)

PROPRIETARY NOTE
THIS DOCUMENT CONTAINS CONFIDENTIAL AND PROPRIETARY INFORMATION AND ALL DESIGN, MANUFACTURING, REPRODUCTION, USE, PATENT RIGHTS AND SALES RIGHTS ARE EXPRESSLY RESERVED BY SAMTEC, INC. THIS DOCUMENT SHALL NOT BE DISCLOSED, IN WHOLE OR PART, TO ANY UNAUTHORIZED PERSON OR ENTITY NOR REPRODUCED, TRANSFERRED OR INCORPORATED IN ANY OTHER PROJECT IN ANY MANNER WITHOUT THE EXPRESS WRITTEN CONSENT OF SAMTEC, INC.

DO NOT SCALE DRAWING

SHEET SCALE: 2:1



520 PARK EAST BLVD, NEW ALBANY, IN 47150
PHONE: 812-944-6733 FAX: 812-948-5047
e-Mail info@SAMTEC.com code 55322

DESCRIPTION: BOX CONNECTOR SOCKET STRIP
DWG. NO. BCS-1XX-XXX-X-XX-XXX
BY: KOLB 09/12/1991 SHEET 3 OF 3