

350mW, PNP Small Signal Transistor

FEATURES

- Low power loss, high efficiency
- Ideal for automated placement
- High surge current capability
- Moisture sensitivity level: level 1, per J-STD-020
- RoHS Compliant
- Halogen-free according to IEC 61249-2-21

APPLICATIONS

- Switching mode power supply (SMPS)
- Adapters
- Lighting application
- On-board DC/DC converter

MECHANICAL DATA

- Case: SOT-23
- Molding compound meets UL 94 V-0 flammability rating
- Terminal: Matte tin plated leads, solderable per J-STD-002
- Meet JESD 201 class 1A whisker test
- Weight: 0.008g(approximately)

KEY PARAMETERS		
PARAMETER	VALUE	UNIT
V_{CBO}	-40	V
V_{CEO}	-40	V
V_{EBO}	-5	V
I_C	-200	mA
h_{FE}	300	
Package	SOT-23	
Configuration	Single die	

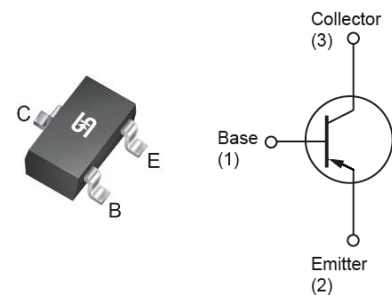

ABSOLUTE MAXIMUM RATINGS ($T_A = 25^\circ\text{C}$ unless otherwise noted)			
PARAMETER	SYMBOL	MMBT3906	UNIT
Marking code on the device		2A	
Collector-base voltage	V_{CBO}	-40	V
Collector-emitter voltage	V_{CEO}	-40	V
Emitter-base voltage	V_{EBO}	-5	V
Collector current, dc	I_C	-200	mA
Power dissipation	P_D	350	mW
Junction temperature	T_J	-55 to +150	$^\circ\text{C}$
Storage temperature	T_{STG}	-55 to +150	$^\circ\text{C}$

THERMAL PERFORMANCE			
PARAMETER	SYMBOL	TYP	UNIT
Junction-to-ambient thermal resistance	$R_{\theta JA}$	357	°C/W

ELECTRICAL SPECIFICATIONS ($T_A = 25^\circ\text{C}$ unless otherwise noted)					
PARAMETER	CONDITIONS	SYMBOL	MIN	MAX	UNIT
Collector-base breakdown voltage	$I_C = -10\mu\text{A}, I_E = 0$	$V_{(BR)CBO}$	-40	-	V
Collector-emitter breakdown voltage	$I_C = -1\text{mA}, I_B = 0$	$V_{(BR)CEO}$	-40	-	V
Emitter-base breakdown voltage	$I_E = -10\mu\text{A}, I_C = 0$	$V_{(BR)EBO}$	-5	-	V
Collector base cutoff current	$V_{CB} = -40\text{V}$	I_{CBO}	-	-100	nA
Emitter base cutoff current	$V_{EB} = -5\text{V}$	I_{EBO}	-	-50	nA
DC current gain	$V_{CE} = -1\text{V}, I_C = -0.1\text{mA}$	h_{FE}	60	300	
	$V_{CE} = -1\text{V}, I_C = -1\text{mA}$		80		
	$V_{CE} = -1\text{V}, I_C = -10\text{mA}$		100		
	$V_{CE} = -1\text{V}, I_C = -50\text{mA}$		60		
	$V_{CE} = -1\text{V}, I_C = -100\text{mA}$		30		
Collector-emitter saturation voltage	$I_C = -10\text{mA}, I_B = -1\text{mA}$	$V_{CE(sat)}$	-	-0.25	V
	$I_C = -50\text{mA}, I_B = -5\text{mA}$		-	-0.4	
Base-emitter saturation voltage	$I_C = -10\text{mA}, I_B = -1\text{mA}$	$V_{BE(sat)}$	-0.65	-0.85	V
	$I_C = -50\text{mA}, I_B = -5\text{mA}$		-	-0.95	
Transition frequency	$V_{CE} = -20\text{V}, I_C = -10\text{mA}, f = 100\text{MHz}$	f_T	250	-	MHz
Output capacitance	$f = 1\text{MHz}, V_{CB} = -5\text{V}, I_E = 0$	C_{OBO}	-	4.5	pF
Delay time	$V_{CC} = -3\text{V}, V_{BE} = -0.5\text{V}, I_C = -10\text{mA}$	t_d	-	35	ns
Rise time	$I_{B1} = -1\text{mA}$	t_r	-	35	ns
Storage time	$V_{CC} = -3\text{V}, I_C = -10\text{mA}$	t_s	-	225	ns
Fall time	$I_{B1} = I_{B2} = -1\text{mA}$	t_f	-	75	ns

ORDERING INFORMATION		
ORDERING CODE⁽¹⁾	PACKAGE	PACKING
MMBT3906 RF	SOT-23	3,000 / 7" Reel
MMBT3906 RFG	SOT-23	3,000 / 7" Reel
MMBT3906 R5	SOT-23	10,000 / 13" Reel
MMBT3906 R5G	SOT-23	10,000 / 13" Reel

Notes:

1. "G" means green compound (halogen free)

CHARACTERISTICS CURVES

($T_A = 25^\circ\text{C}$ unless otherwise noted)

Fig.1 Capacitance

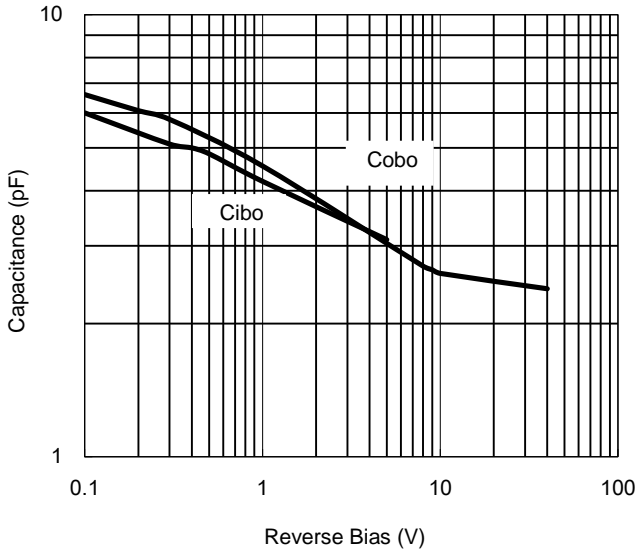

Fig.2 Charge Data

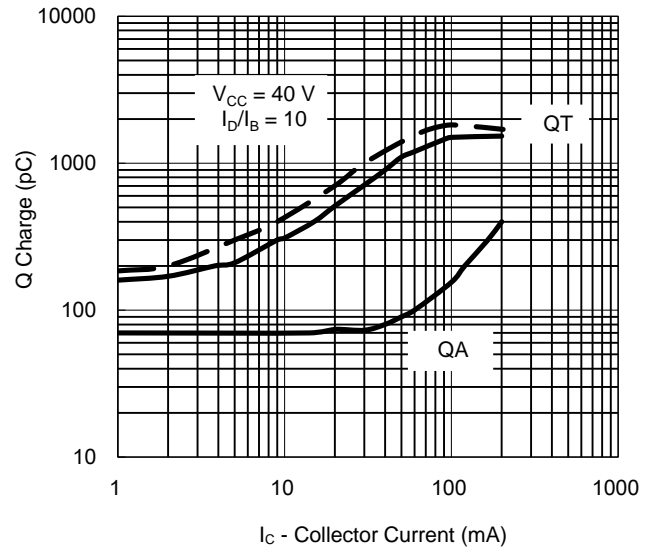

Fig.3 Turn - On Time

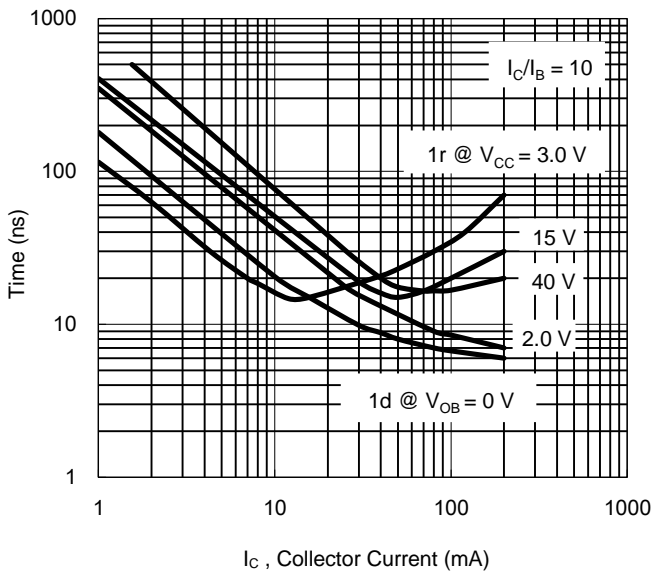
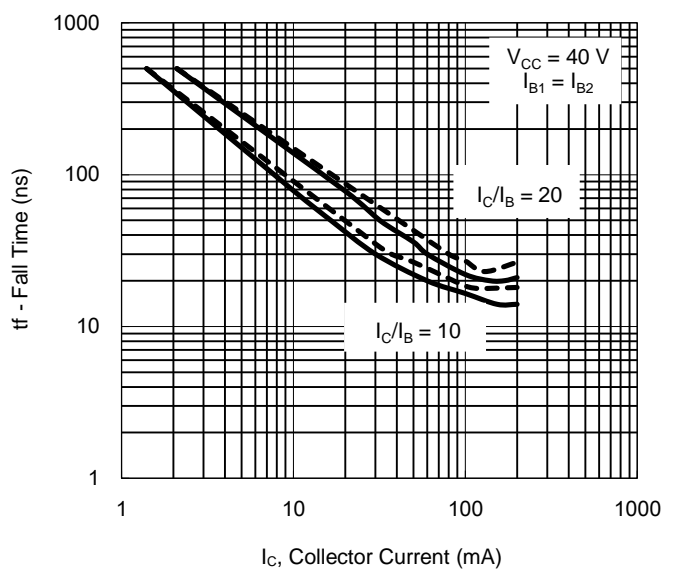

Fig.4 Fall Time



CHARACTERISTICS CURVES

($T_A = 25^\circ\text{C}$ unless otherwise noted)

Fig.5 Noise Figure VS. Frequency

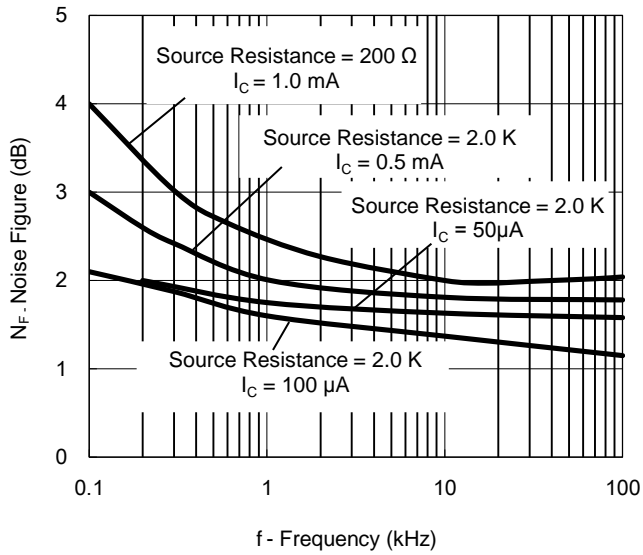

Fig.6 Noise Figure VS. Source Resistance

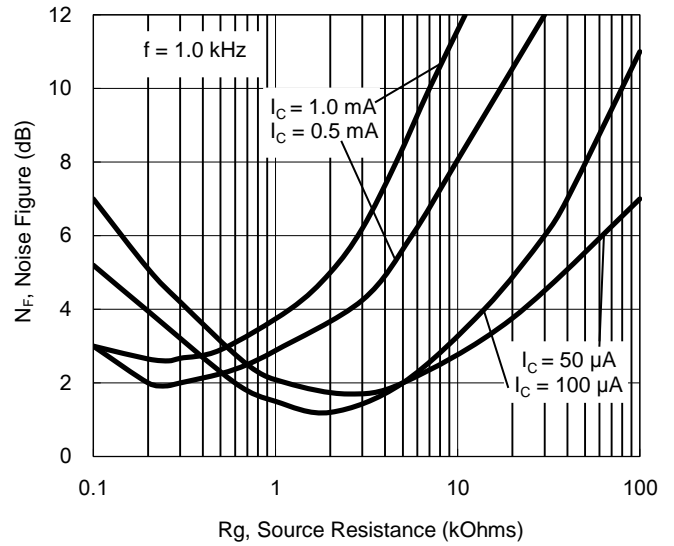

Fig.7 Current Gain

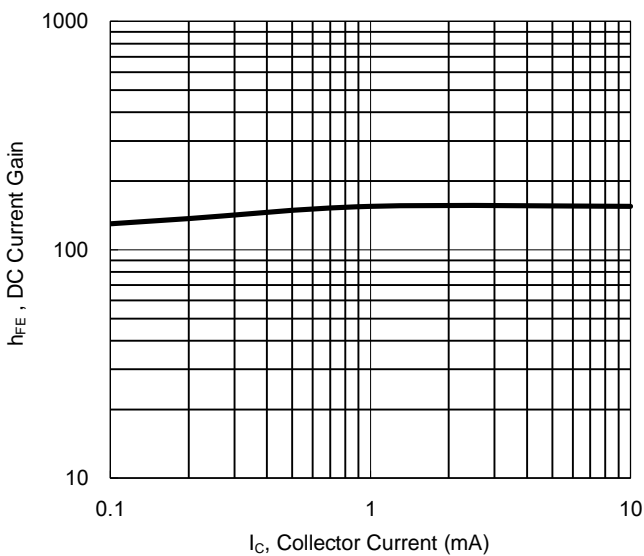
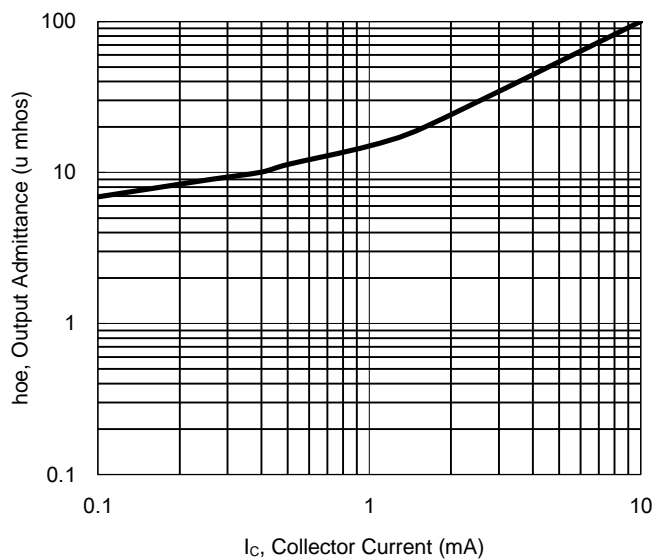

Fig.8 Output Admittance



CHARACTERISTICS CURVES

($T_A = 25^\circ\text{C}$ unless otherwise noted)

Fig.9 Input Impedance

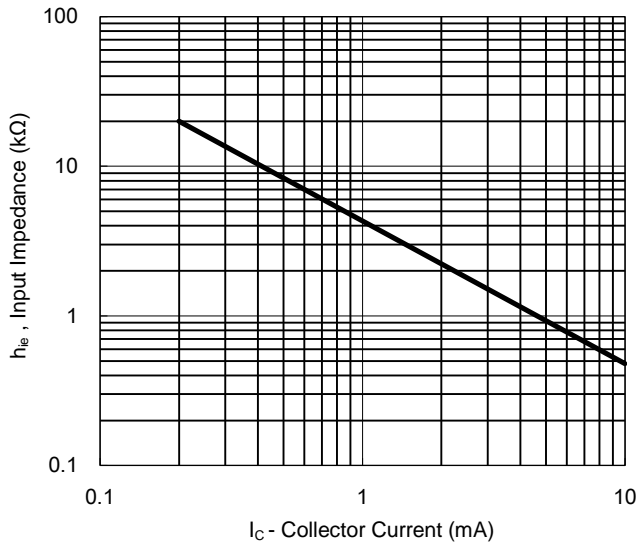

Fig.10 Voltage Feedback Ratio

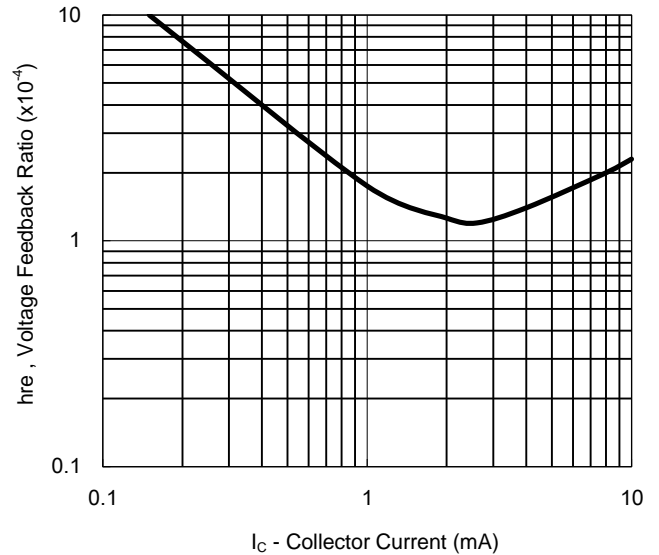

Fig.11 "ON" Voltages

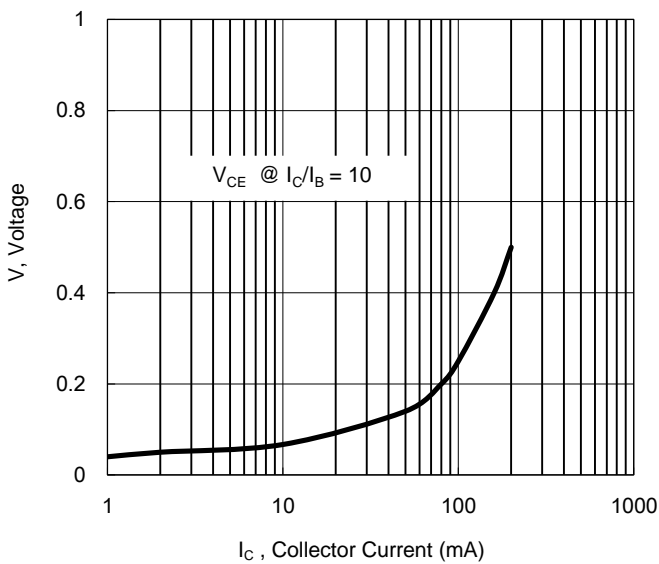
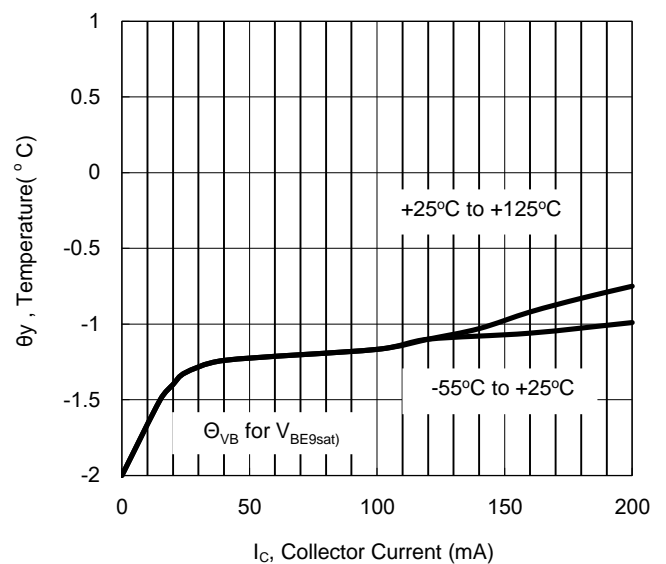
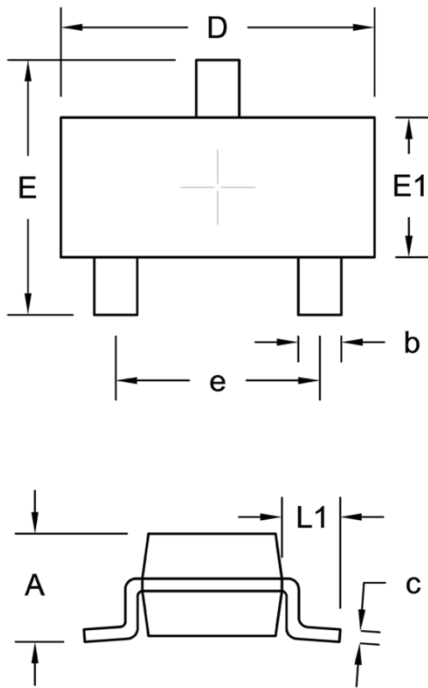

Fig.12 Temperature Coefficients



PACKAGE OUTLINE DIMENSION

SOT-23



DIM.	Unit (mm)		Unit (inch)	
	Min.	Max.	Min.	Max.
A	0.89	1.12	0.035	0.044
b	0.30	0.50	0.012	0.020
c	0.08	0.20	0.003	0.008
D	2.80	3.04	0.110	0.120
E	2.10	2.64	0.083	0.104
E1	1.20	1.40	0.047	0.055
e	1.90 BSC		0.075 BSC	
L1	0.54 REF.		0.021 REF.	

SUGGESTED PAD LAYOUT

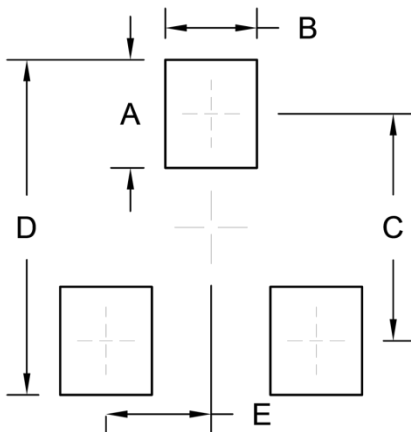

Symbol	Unit (mm)	Unit (inch)
A	1.00	0.039
B	0.85	0.033
C	2.10	0.083
D	3.10	0.122
E	0.98	0.039

Notice

Specifications of the products displayed herein are subject to change without notice. TSC or anyone on its behalf, assumes no responsibility or liability for any errors or inaccuracies.

Purchasers are solely responsible for the choice, selection, and use of TSC products and TSC assumes no liability for application assistance or the design of Purchasers' products.

Information contained herein is intended to provide a product description only. No license, express or implied, to any intellectual property rights is granted by this document. Except as provided in TSC's terms and conditions of sale for such products, TSC assumes no liability whatsoever, and disclaims any express or implied warranty, relating to sale and/or use of TSC products including liability or warranties relating to fitness for a particular purpose, merchantability, or infringement of any patent, copyright, or other intellectual property right.

The products shown herein are not designed for use in medical, life-saving, or life-sustaining applications. Customers using or selling these products for use in such applications do so at their own risk and agree to fully indemnify TSC for any damages resulting from such improper use or sale.