



5 VOLT-SURFACE MOUNT

Monolithic Amplifier

GVA-84+

50Ω DC-7 GHz

THE BIG DEAL

- High Gain, 24 dB typ. at 100 MHz
- High Pout, P1dB 20.5 dBm typ. at 100 MHz
- High IP3, 37 dBm typ. at 100 MHz
- Ruggedized design
- Fixed 5V operation
- Unconditionally stable
- Excellent ESD Protection
- Transient protected, US patent 6,943,629

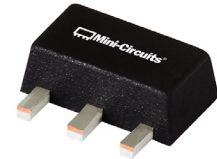

Generic photo used for illustration purposes only

CASE STYLE: DF782

+RoHS Compliant

The +Suffix identifies RoHS Compliance. See our web site for RoHS Compliance methodologies and qualifications

LTE Performance

APPLICATIONS

- Base station infrastructure
- Portable Wireless
- CATV & DBS
- MMDS & Wireless LAN
- LTE

PRODUCT OVERVIEW

GVA-84+ (RoHS compliant) is a wideband amplifier offering high dynamic range. Lead finish is SnAgNi. It has repeatable performance from lot to lot and is enclosed in a SOT-89 package. It uses patented Transient Protected Darlington configuration and is fabricated using InGaP HBT technology.

SIMPLIFIED SCHEMATIC AND PIN DESCRIPTION

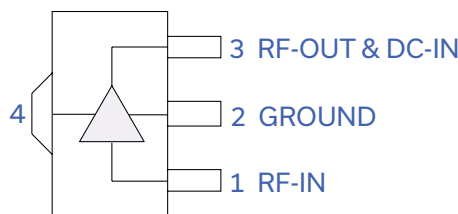
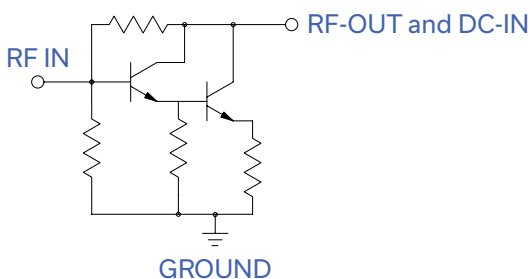

Function	Pin Number	Description
RF IN	1	RF input pin. This pin requires the use of an external DC blocking capacitor chosen for the frequency of operation.
RF-OUT and DC-IN	3	RF output and bias pin. DC voltage is present on this pin; therefore a DC blocking capacitor is necessary for proper operation. An RF choke is needed to feed DC bias without loss of RF signal due to the bias connection, as shown in "Recommended Application Circuit", Fig. 2
GND	2,4	Connections to ground. Use via holes as shown in "Suggested Layout for PCB Design" to reduce ground path inductance for best performance.

REV. E
ECO-010314
M151107
GVA-84+
ED-11756/5E
211026





5 VOLT-SURFACE MOUNT

Monolithic Amplifier

GVA-84+

Mini-Circuits

ELECTRICAL SPECIFICATIONS⁽¹⁾ AT 25°C AND 5V, UNLESS NOTED

Parameter	Condition (GHz)	Min.	Typ.	Max.	Units
Frequency Range ⁽²⁾		DC		7	GHz
Gain	0.1	22.9	24.1	25.3	dB
	1.0	—	21.7	—	
	2.0	17.4	18.4	19.9	
	3.0	—	16.0	—	
	4.0	13.8	14.6	16.3	
	6.0	—	12.5	—	
	7.0	—	10.5	—	
Magnitude of Gain Variation versus Temperature ⁽³⁾ (values are negative)	0.1	—	0.0004	—	dB/°C
	1.0	—	0.0021	—	
	2.0	—	0.0032	0.006	
	3.0	—	0.0044	—	
	4.0	—	0.0058	—	
	6.0	—	0.0131	—	
	7.0	—	0.0175	—	
Input Return Loss	0.1	—	22.9	—	dB
	1.0	—	20.6	—	
	2.0	15.0	18.5	—	
	3.0	—	18.1	—	
	4.0	—	19.1	—	
	6.0	—	17.9	—	
	7.0	—	11.9	—	
Output Return Loss	0.1	—	23.3	—	dB
	1.0	—	10.7	—	
	2.0	6.0	7.7	—	
	3.0	—	7.1	—	
	4.0	—	7.0	—	
	6.0	—	6.3	—	
	7.0	—	5.6	—	
Reverse Isolation	2.0		26.5		dB
Output Power @1 dB compression	0.1	19.4	20.4	—	dBm
	1.0	19.5	20.5	—	
	2.0	19.6	20.6	—	
	3.0	—	21.0	—	
	4.0	—	19.9	—	
	6.0	—	17.0	—	
	7.0	—	15.6	—	
Saturated Output Power (at 3dB compression)	0.1		21.7		dBm
	1.0		22.3		
	2.0		22.3		
	3.0		22.2		
	4.0		21.0		
	6.0		18.9		
	7.0		17.2		
Output IP3	0.1	33.0	36.7	—	dBm
	1.0	32.2	35.8	—	
	2.0	32.9	36.6	—	
	3.0	—	35.8	—	
	4.0	—	34.9	—	
	6.0	—	33.0	—	
	7.0	—	32.0	—	
Noise Figure	0.1	—	5.5	6.5	dB
	1.0	—	5.6	—	
	2.0	—	5.5	6.5	
	3.0	—	5.5	—	
	4.0	—	5.6	6.6	
	6.0	—	6.2	—	
	7.0	—	6.8	—	
Group Delay	2.0		94		psec
Device Operating Voltage		4.8	5.0	5.2	V
Device Operating Current		85	108	130	mA
Device Current Variation vs. Temperature			61.8		µA/°C
Device Current Variation vs Voltage			0.058		mA/mV
Thermal Resistance, junction-to-ground lead			64		°C/W





MAXIMUM RATINGS

Parameter	Ratings
Operating Temperature (ground lead)	-45°C to 85°C
Storage Temperature	-65°C to 150°C
Operating Current at 5V	160mA
Power Dissipation	1W
Input Power	13 dBm
DC Voltage on Pin 3	5.8V

Permanent damage may occur if any of these limits are exceeded.
Electrical maximum ratings are not intended for continuous normal operation.

CHARACTERIZATION TEST CIRCUIT

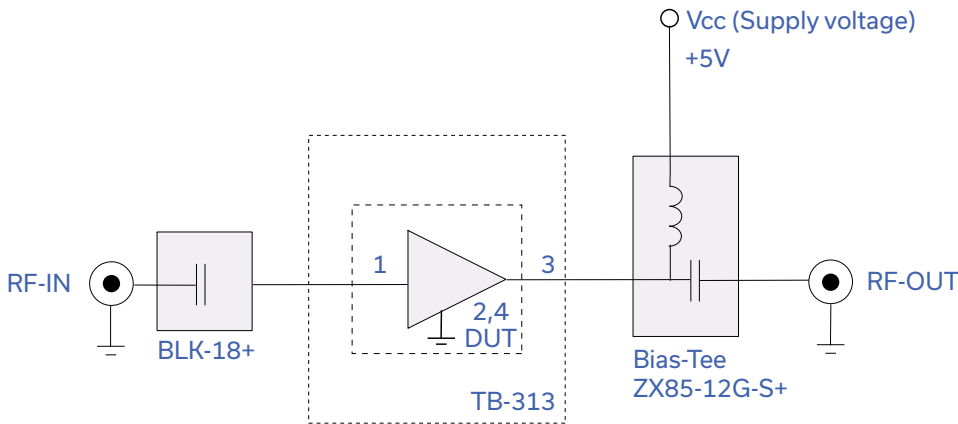

Fig 1. Block Diagram of Test Circuit used for characterization. (DUT soldered on Mini-Circuits Test Board TB-313)

Gain, Output power at 1dB compression (P1 dB) and output IP3 (OIP3) are measured using R&S Network Analyzer ZVA-24. Noise Figure measured using Agilent's N5242A PNA-X microwave network analyzer.

Conditions:

1. Gain and Return loss: Pin= -25dBm
2. Output IP3 (OIP3): Two tones, spaced 1 MHz apart, 0 dBm/tone at output.



5 VOLT-SURFACE MOUNT

Monolithic Amplifier

GVA-84+

RECOMMENDED APPLICATION CIRCUIT

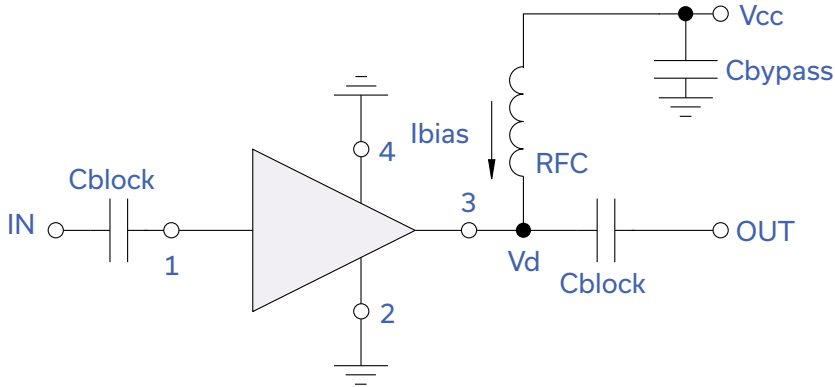
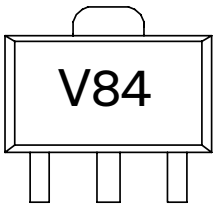

Fig 2. Test Board includes case, connectors, and components soldered to PCB.

PRODUCT MARKING



Marking may contain other features or characters for internal lot control



ADDITIONAL DETAILED TECHNICAL INFORMATION IS AVAILABLE ON OUR DASH BOARD. TO ACCESS [CLICK HERE](#)

Performance Data	Data Table
	Swept Graphs
	S-Parameter (S2P Files) Data Set (.zip file)
Case Style	DF782 (SOT 89) Plastic package, exposed paddle lead finish: matte-tin
Tape & Reel Standard quantities available on reel	F55 7" reels with 20, 50, 100, 200, 500 or 1K devices
Suggested Layout for PCB Design	PL-255
Evaluation Board	TB-410-84+
Environmental Ratings	ENV08T1

ESD RATING

Human Body Model (HBM): Class 1C (1000v to < 2000v) in accordance with ANSI/ESD STM 5.1 - 2001

Machine Model (MM): Class M2 (100V to < 200V) in accordance with ANSI/ESD STM 5.2 - 1999

MSL RATING

Moisture Sensitivity: MSL1 in accordance with IPC/JEDECJ-STD-020D

MSL TEST FLOW CHART

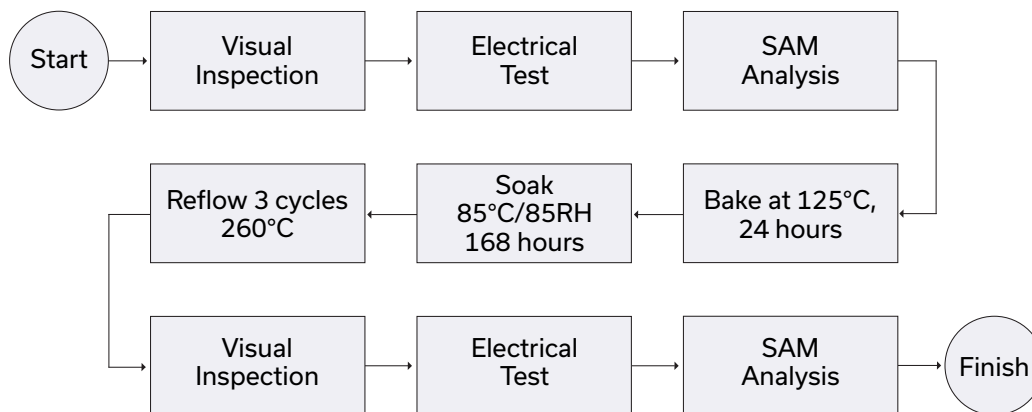

- NOTES**
- A. Performance and quality attributes and conditions not expressly stated in this specification document are intended to be excluded and do not form a part of this specification document.
 - B. Electrical specifications and performance data contained in this specification document are based on Mini-Circuit's applicable established test performance criteria and measurement instructions.
 - C. The parts covered by this specification document are subject to Mini-Circuits standard limited warranty and terms and conditions (collectively, "Standard Terms"); Purchasers of this part are entitled to the rights and benefits contained therein. For a full statement of the standard. Terms and the exclusive rights and remedies thereunder, please visit Mini-Circuits' website at www.minicircuits.com/MCLStore/terms.jsp