



Product Description

The FMS2031-001 is a 10W, Single-pole, Double-throw, (SPDT) GaAs pHEMT reflective antenna switch. The switch offers excellent power handling capability and harmonic performance. The FMS2031-001 is designed for use in WiMax, L-, S-, and C-band wireless applications and WiFi access points where high linearity switching is required.

Features

- 31dB Isolation at 2.5 GHz
- 0.5dB Insertion Loss at 2.5GHz
- P_{0.1dB} 41dBm at 2.3GHz
- Less than 10µA Control Current at 35dBm Input Power

Applications

- WiMax
- L-, S-, and C-band Applications
- WiFi Applications

Optimum Technology Matching® Applied

- GaAs HBT
- GaAs MESFET
- InGaP HBT
- SiGe BiCMOS
- Si BiCMOS
- SiGe HBT
- GaAs pHEMT
- Si CMOS
- Si BJT
- GaN HEMT
- InP HBT
- RF MEMS
- LDMOS

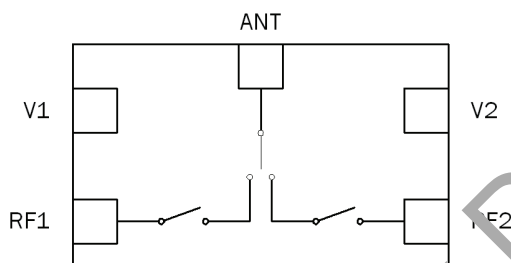

Parameter	Specification			Unit	Condition
	Min.	Typ.	Max.		
Electrical Specifications					
T _{AMBIENT} = 25 °C, V _{CTRL} = 0V/2.7V, Z _{IN} = Z _{OUT} = 50Ω					
Insertion Loss		0.5	0.7	dB	DC to 3GHz
		1		dB	3GHz to 4GHz
		0.9		dB	4GHz to 5GHz
Return Loss		20		dB	DC to 4GHz
		15		dB	4GHz to 5GHz
		10		dB	4.9GHz to 5.9GHz
Isolation	30	32		dB	DC to 3GHz
		29		dB	3GHz to 4GHz
		23		dB	4GHz to 5GHz
P _{IN} at 0.1dB Compression Point		43		dBm	900MHz
		41		dBm	2.3GHz
2nd Harmonic		-83	-73	dBc	900MHz, 35dBm CW
		-85		dBc	1950MHz, 33dBm CW
3rd Harmonic		-85	-73	dBc	900MHz, 35dBm CW
		-81		dBc	1950MHz, 33dBm CW
EVM (Contribution Due to Switch)		Δ0.5		%	35dBm at 5.9GHz (OFDM WiFi 54)
IIP3		60		dBm	1950MHz, 1MHz spacing, +20dBm per tone
IIP2		87		dBm	1950MHz, 1MHz spacing, +20dBm per tone
Switching Speed: T _{RISE} , T _{FALL}		90		ns	10% to 90% RF and 90% to 10% RF
Switching Speed: T _{ON} , T _{OFF}		350		ns	50% control to 10% and 90% RF
Control Current		<5	10	µA	+35dBm RF input @ 0.96GHz

RF MICRO DEVICES®, RFMD®, Optimum Technology Matching®, Enabling Wireless Connectivity™, PowerStar®, POLARIS™ TOTAL RADIO™ and UltimateBlue™ are trademarks of RFMD, LLC. BLUETOOTH is a trademark owned by Bluetooth SIG, Inc., U.S.A. and licensed for use by RFMD. All other trade names, trademarks and registered trademarks are the property of their respective owners. ©2006, RF Micro Devices, Inc.

Absolute Maximum Ratings

Parameter	Rating	Unit
Max Input Power, OFDM Modulated, 3:1 Load VSWR	+39	dBm
Max Input Power, 2:1 VSWR	+41	dBm
ESD HBM Rating	Class 1A	
Control Voltage	+6	V
Operating Temperature	-40 to 85	°C
Maximum Junction Temperature	125	°C
Storage Temperature	-55 to 150	°C



Caution! ESD sensitive device.

Exceeding any one or a combination of the Absolute Maximum Rating conditions may cause permanent damage to the device. Extended application of Absolute Maximum Rating conditions to the device may reduce device reliability. Specified typical performance or functional operation of the device under Absolute Maximum Rating conditions is not implied.

RoHS status based on EU Directive 2002/95/EC (at time of this document revision).

The information in this publication is believed to be accurate and reliable. However, no responsibility is assumed by RF Micro Devices, Inc. ("RFMD") for its use, nor for any infringement of patents, or other rights of third parties, resulting from its use. No license is granted by implication or otherwise under any patent or patent rights of RFMD. RFMD reserves the right to change component circuitry, recommended application circuitry and specifications at any time without prior notice.

Notes:

At high powers, the dissipation in the switch can be significant and the resulting thermal effects need to be taken into account. The device should be appropriately heat-sinked.

For thermal calculations, the dissipation within the switch should be taken as $\eta = 5.5\%$. This should include the power input to the switch and reflected back from an external mismatch.

The thermal resistance of the switch is $R_{TH} = 70^\circ\text{C}/\text{W}$.

$$T_J = T_{OP} + P_{IN} \cdot \eta \cdot R_{TH}, \text{ where } T_J < T_{JMAX}$$

Disclaimer

This product is not designed for use in any space-based or life-sustaining/ supporting equipment.

Truth Table

Switch State	VC1	VC2	ANT - RF1	ANT - RF2
A	High	Low	Insertion loss	Isolation
B	Low	High	Isolation	Insertion Loss

Note: External DC blocking capacitors are required on all RF ports. All unused ports terminated in 50Ω.

High: +2.3V to +6V. Low: +0V to +0.2V.

Ordering Information

Delivery Quantity	Ordering Code
Reel of 1000	FMS2031-001
Reel of 100	FMS2031-001SR
Bag of 25	FMS2031-001SQ
Bag of 5	FMS2031-001SB
Evaluation Board	FMS2031-001-PCK1

Typical Measured Performance on Evaluation Board (De-embedded)

Measurement Conditions: $V_{CTRL}=2.7V$ (high) and $0V$ (low), $T_{AMBIENT}=25^{\circ}C$ unless otherwise stated.

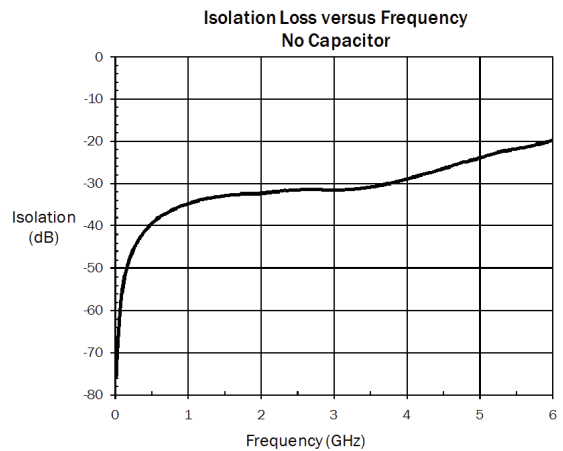
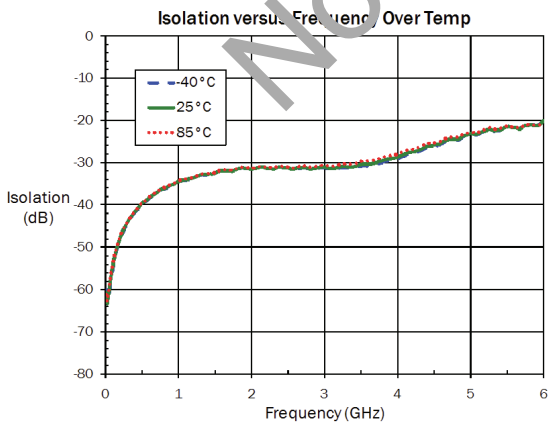
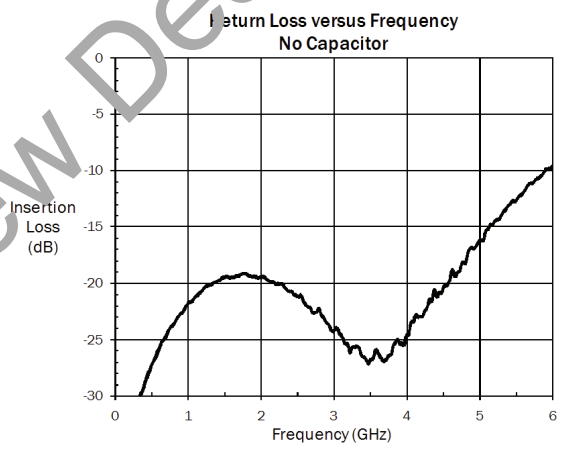
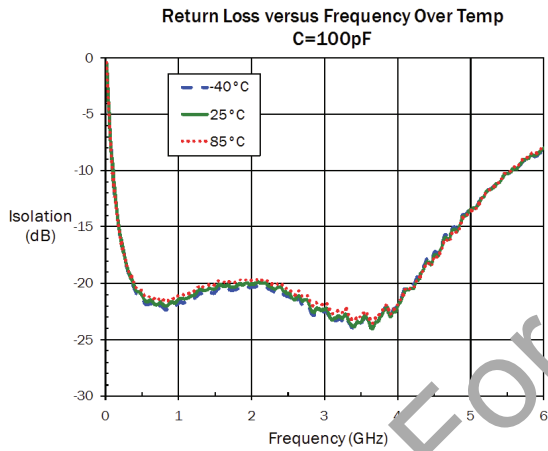
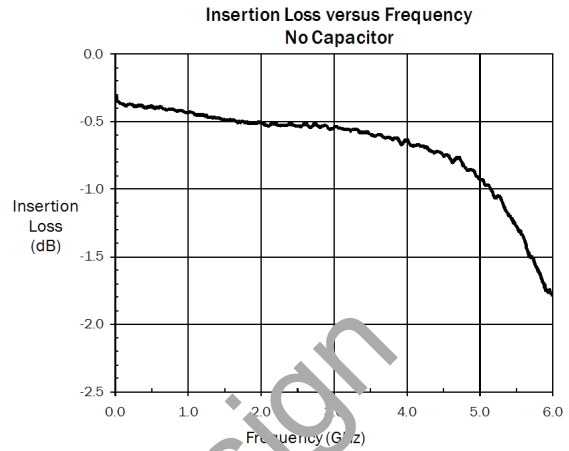
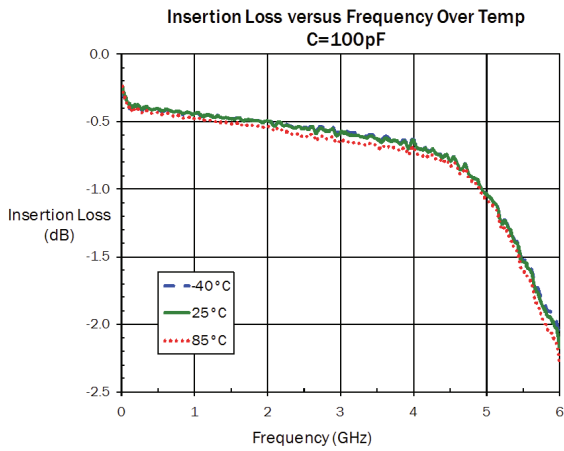

Typical Measured Performance on Evaluation Board (De-embedded)

Measurement Conditions: $V_{CTRL} = 2.7V$ (high) and $0V$ (low), $T_{AMBIENT} = 25^\circ C$ unless otherwise stated.

2nd Harmonic, 880MHz, 35dBm, Over Temp

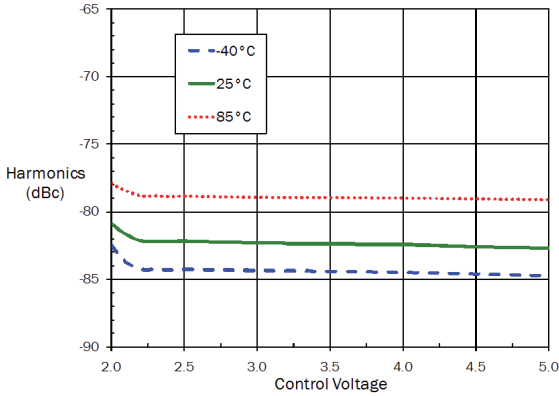

2nd Harmonic, 1880MHz, 33dBm, Over Temp

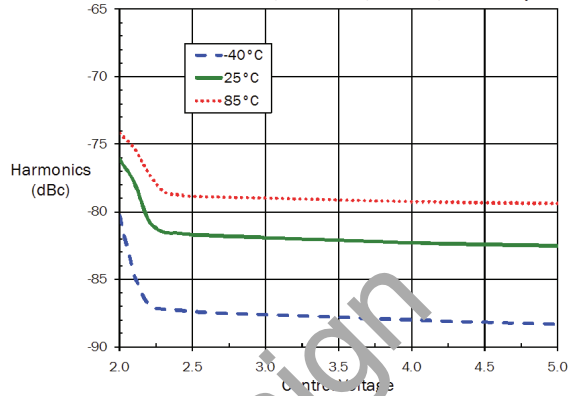

3rd Harmonic, 880MHz, 35dBm, Over Temp

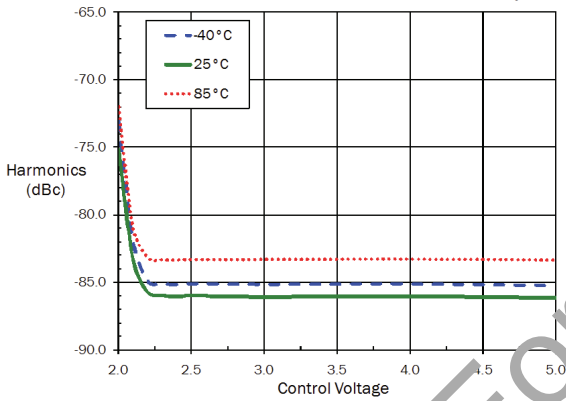

3rd Harmonic, RF1, 1880MHz, 33dBm, Over Temp

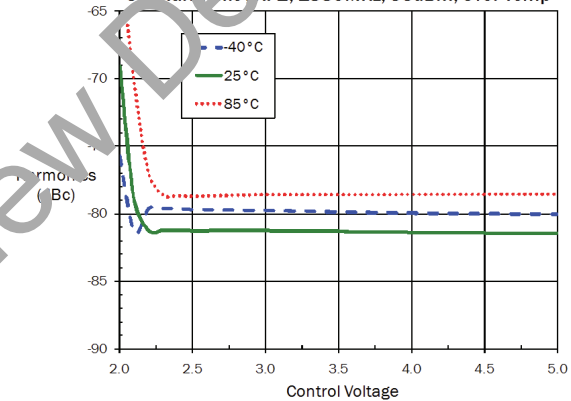

Harmonics versus Input Power (1880MHz, $V_C = 2.7V$, $25^\circ C$)

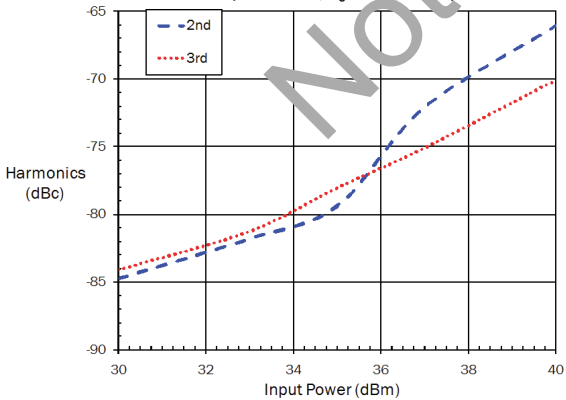

FMS2031 P0.1dB Compression versus Voltage

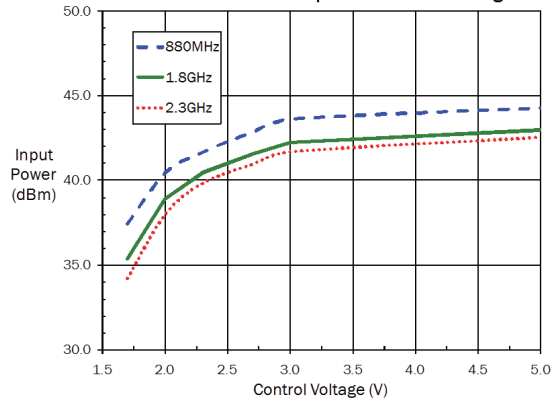

Part Identification

Pin 1
Mark

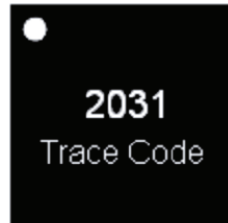

First row: Device code “2031”. Second row: Trace Code, to be assigned by SubCon.

Package Drawing
QFN 12-Lead 3mmx3mm

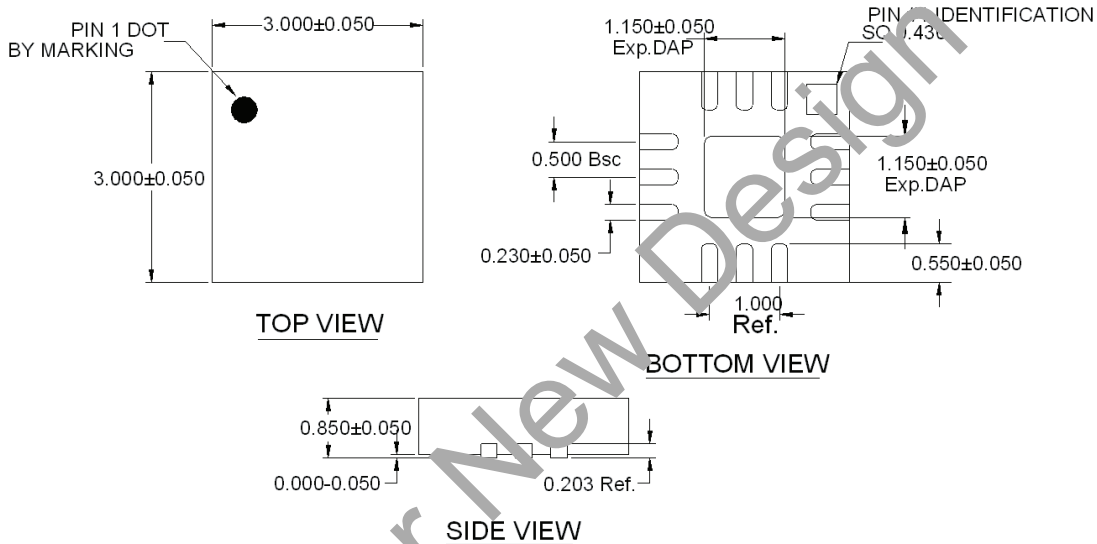

Pad Layout

Pin	Function	Description
1	NC	No connect.
2	NC	No connect.
3	NC	No connect.
4	RF2	RF port 2, DC block required
5	NC	No connect.
6	NC	No connect.
7	V2	V2 logic control voltage
8	ANT RF	RF common port, DC block required
9	V1	V1 logic control voltage
10	NC	No connect.
11	NC	No connect.
12	RF1	RF port 1, DC block required
	Paddle	Ground.

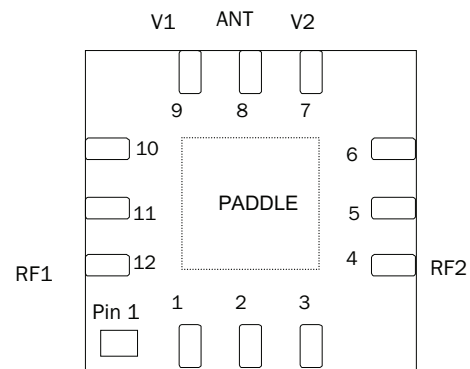

Tape and Reel Specification

Tape and reel information on this material is in accordance with EIA-481-1 except where exceptions are identified.

Evaluation Board Layout

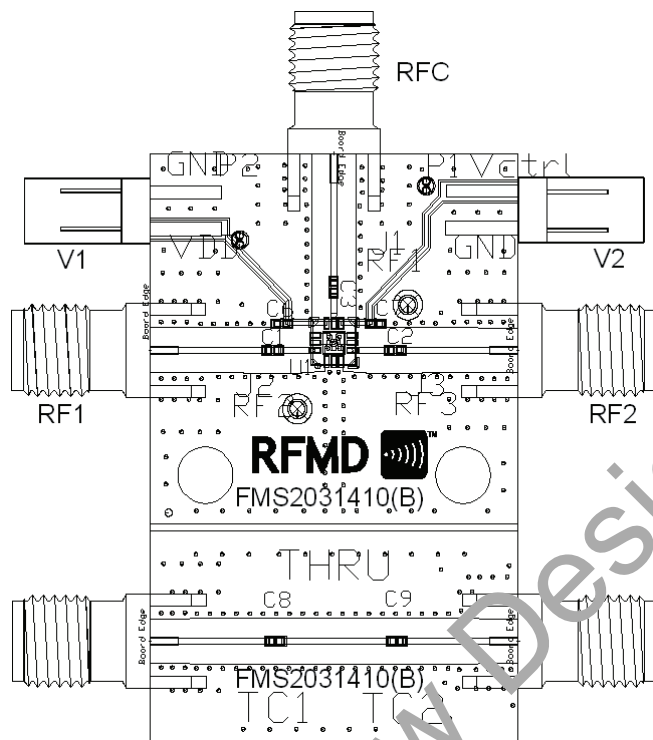

Bill of Materials

Label	Component
C1-C9	Capacitor, 100pF, 0402

Not For New Design