

QUAD SCHOTTKY DATA LINE BUS TERMINATOR

This highly integrated device is designed as rail to rail overvoltage protection clamp for up to four high frequency data lines. It is ideal in portable applications where small form factors are required.

FEATURES

- Low Forward Voltage Drop for Improved Voltage Protection
- Very Fast Switching
- Ultra Small SOT-363 Package Utilizing Minimal Board Space
- Lead free in Wet and Unwet Ink (91% FC < G & S % / #) #01 Xj f YWij Y'
- Green molding compound as per IEC61249 Std. . (Halogen Free)

APPLICATIONS

- PDAs
- Portable Computers

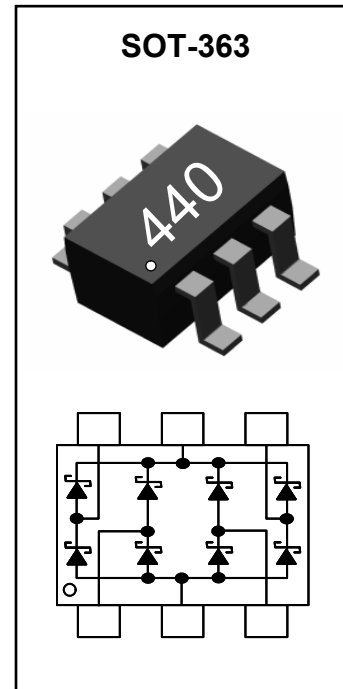

MAXIMUM RATINGS $T_A = 25^\circ\text{C}$, unless otherwise noted

Rating	Symbol	Value	Units
Marking Code		440	
Reverse Voltage	V_R	30	V
Continuous Forward Current	I_F	200	mA
Non-Repetitive Surge Current, $t=1\text{s}$	I_{FSM}	600	mA
Power Dissipation (Note 1)	P_D	200	mW
Operating Junction Temperature Range	T_J	-55 to +125	$^\circ\text{C}$
Storage Temperature Range	T_{STG}	-65 to +125	$^\circ\text{C}$

Note 1: Device mounted on FR-4 board 1.0 inch x 0.85 inch x 0.062 inch, with minimum pad layout

THERMAL CHARACTERISTICS

Characteristic	Symbol	Value	Units
Thermal Resistance, Junction to Ambient	R_{thja}	625	$^\circ\text{C/W}$

ELECTRICAL CHARACTERISTICS (Each Diode)
 $T_J = 25^\circ\text{C}$, unless otherwise noted

Characteristic		Symbol	Min	Typ	Max	Units
Reverse Breakdown Voltage (Note 2)	$I_R = 100\mu\text{A}$	V_{BR}	30	-	-	V
Forward Voltage (Note 2)	$I_F = 0.1\text{mA}$	V_F	-	0.225	0.280	V
	$I_F = 1.0\text{mA}$		-	0.280	0.350	
	$I_F = 10\text{mA}$		-	0.350	0.450	
	$I_F = 30\text{mA}$		-	0.390	0.550	
	$I_F = 100\text{mA}$		-	0.460	1.0	
Reverse Leakage Current (Note 2)	$V_R = 25\text{V}$	I_R	-	-	2.0	μA
Total Capacitance $V_R = 0\text{V}$, $f = 1.0\text{MHz}$	Data Line to Ground	C_T	-	19	-	pF
	Between Data Lines		-	12	-	
Reverse Recovery Time	$I_F = I_R = 10\text{mA}$ $I_{rr} = 1.0\text{mA}$, $R_L = 100\text{Ohm}$	t_{rr}	-	-	5.0	ns

Note 2: Short duration test pulse to minimize self heating



PJ4L40

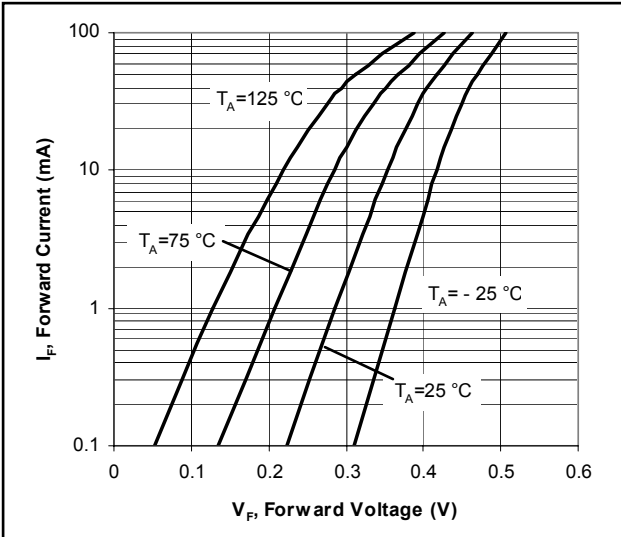

Fig. 1. Typical Forward Voltage

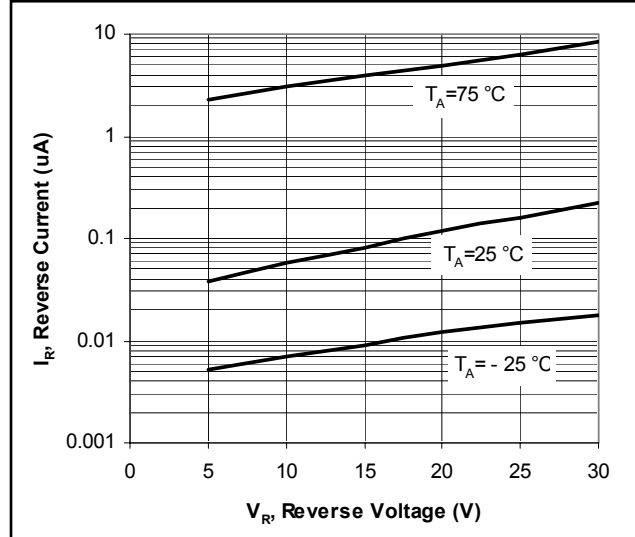

Fig. 2. Typical Reverse Current

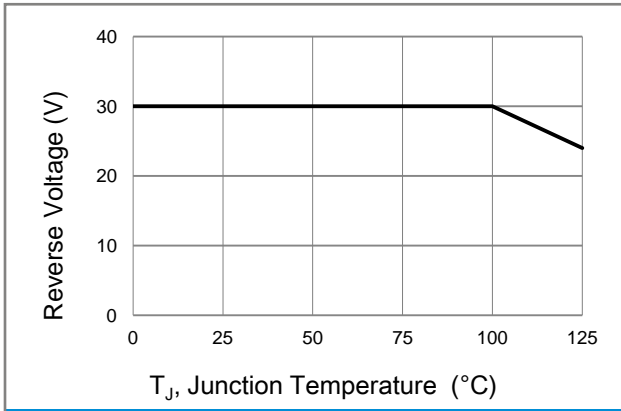
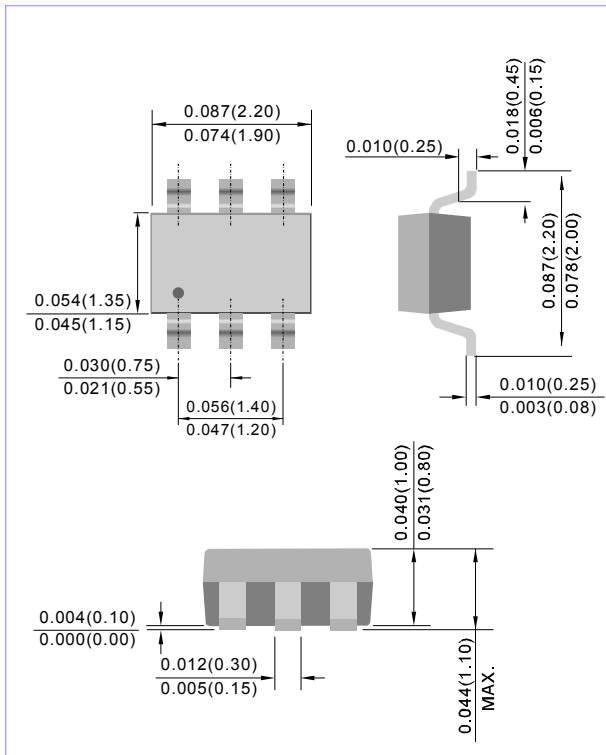

Fig. 3. Operating Temperature Derating Curve

PACKAGE LAYOUT AND SUGGESTED PAD DIMENSIONS

SOT-363

Unit : inch(mm)



SOT-363

Unit : inch(mm)

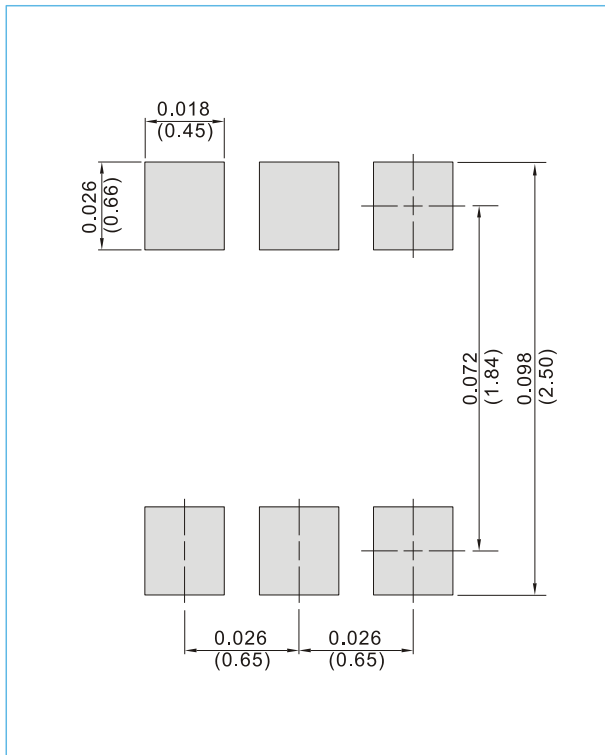

ORDERING INFORMATION

PJ4L40 T/R7 - 7 inch reel, 3K units per reel

PJ4L40 T/R13 - 13 inch reel, 10K units per reel

Note :

1. To protect data lines and the power line, connect pins 2 and 3 directly to the positive supply rail (V_{CC}). In this configuration the data lines are referenced to the supply voltage. An external TVS diode may be added between the supply rail and ground in order to prevent over-voltage on the supply rail.
2. In applications where no positive supply reference is available, or complete supply isolation is desired, an external TVS diode may be used as the reference. The steering diodes will begin to conduct when the voltage on the protected line exceeds the working voltage of the TVS (plus one diode drop).



PJ4L40

Part No_packing code_Version

PJ4L40_R1_00001

PJ4L40_R2_00001

For example :

RB500V-40_R2_00001

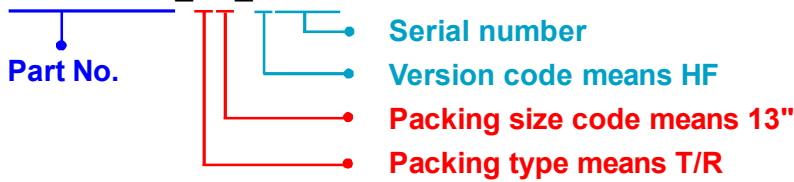

Packing Code XX				Version Code XXXXX		
Packing type	1 st Code	Packing size code	2 nd Code	HF or RoHS	1 st Code	2 nd ~5 th Code
Tape and Ammunition Box (T/B)	A	N/A	0	HF	0	serial number
Tape and Reel (T/R)	R	7"	1	RoHS	1	serial number
Bulk Packing (B/P)	B	13"	2			
Tube Packing (T/P)	T	26mm	X			
Tape and Reel (Right Oriented) (TRR)	S	52mm	Y			
Tape and Reel (Left Oriented) (TRL)	L	PANASERT T/B CATHODE UP (PBCU)	U			
FORMING	F	PANASERT T/B CATHODE DOWN (PBCD)	D			



PJ4L40

Disclaimer

- Reproducing and modifying information of the document is prohibited without permission from Panjit International Inc..
- Panjit International Inc. reserves the rights to make changes of the content herein the document anytime without notification. Please refer to our website for the latest document.
- Panjit International Inc. disclaims any and all liability arising out of the application or use of any product including damages incidentally and consequentially occurred.
- Panjit International Inc. does not assume any and all implied warranties, including warranties of fitness for particular purpose, non-infringement and merchantability.
- Applications shown on the herein document are examples of standard use and operation. Customers are responsible in comprehending the suitable use in particular applications. Panjit International Inc. makes no representation or warranty that such applications will be suitable for the specified use without further testing or modification.
- The products shown herein are not designed and authorized for equipments requiring high level of reliability or relating to human life and for any applications concerning life-saving or life-sustaining, such as medical instruments, transportation equipment, aerospace machinery et cetera. Customers using or selling these products for use in such applications do so at their own risk and agree to fully indemnify Panjit International Inc. for any damages resulting from such improper use or sale.
- Since Panjit uses lot number as the tracking base, please provide the lot number for tracking when complaining.