



Maxim > Design Support > Technical Documents > Reference Designs > Automotive > APP 4380
Maxim > Design Support > Technical Documents > Reference Designs > LED Lighting > APP 4380
Maxim > Design Support > Technical Documents > Reference Designs > Prototyping and PC-Board Layout > APP 4380

Keywords: LED Driver Linear RCL Rear Combination Lamp

REFERENCE DESIGN 4380 INCLUDES: ✓Tested Circuit ✓Schematic ✓Description ✓Test Data ✓Layout

Reference Design for a 3S3P Rear Combination Lamp (RCL) LED Driver

By: Jim Christensen, Strategic Applications Engineer
May 05, 2009

Abstract: This application note presents a reference design for a rear combination lamp (RCL) LED driver in a 3-series, 3-parallel (3S3P) configuration. Using the MAX16823 linear driver and external BJTs, this design provides 200mA per string as well as enhanced heat dissipation. Also included is PWM dimming circuitry for tail-light inputs and full brightness for brake-light inputs. Double-battery and load-dump conditions have been taken into consideration.

Overview

This reference design uses the [MAX16823](#) 3-channel linear LED driver and external BJTs to implement a 3S3P RCL driver circuit. **Figures 1** and **2** present images of the PCB and attached heatsink; **Figure 3** illustrates the layout of the design; and **Figure 4** provides the schematic for the circuit.

The reference design is discussed in detail below, with analysis of the main circuit blocks, design specifications, and performance data.

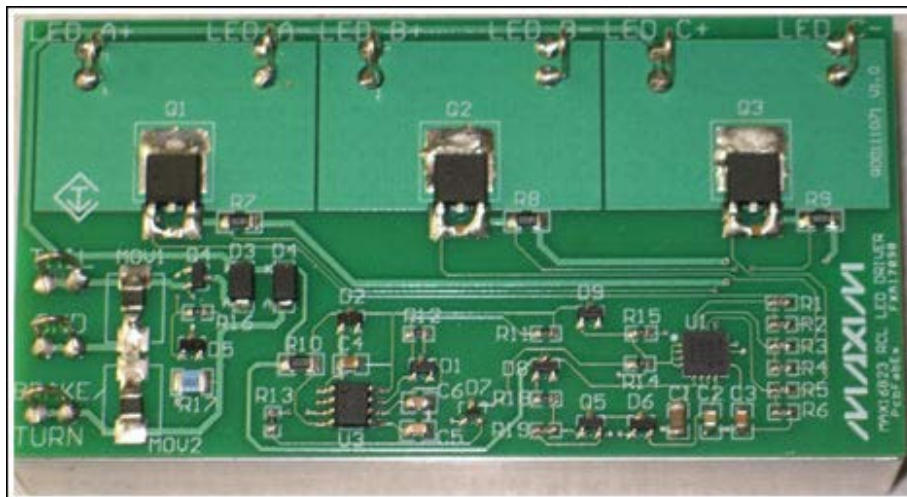

[More detailed image \(PDF, 1.89MB\)](#)
Figure 1. PCB and attached heatsink.

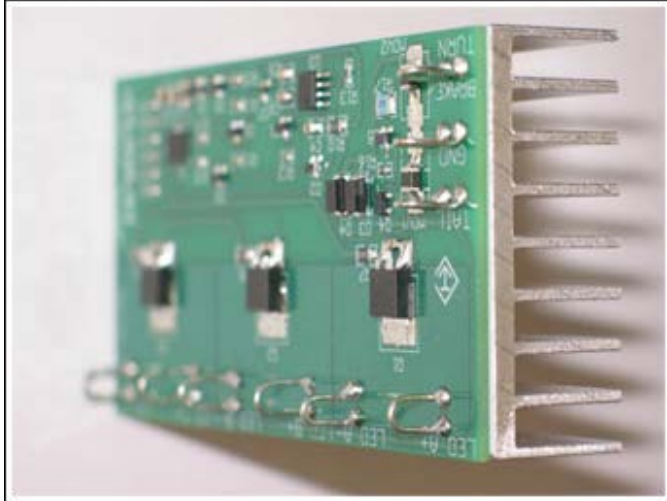

[More detailed image \(PDF, 1.49MB\)](#)
Figure 2. Side view of the attached heatsink.

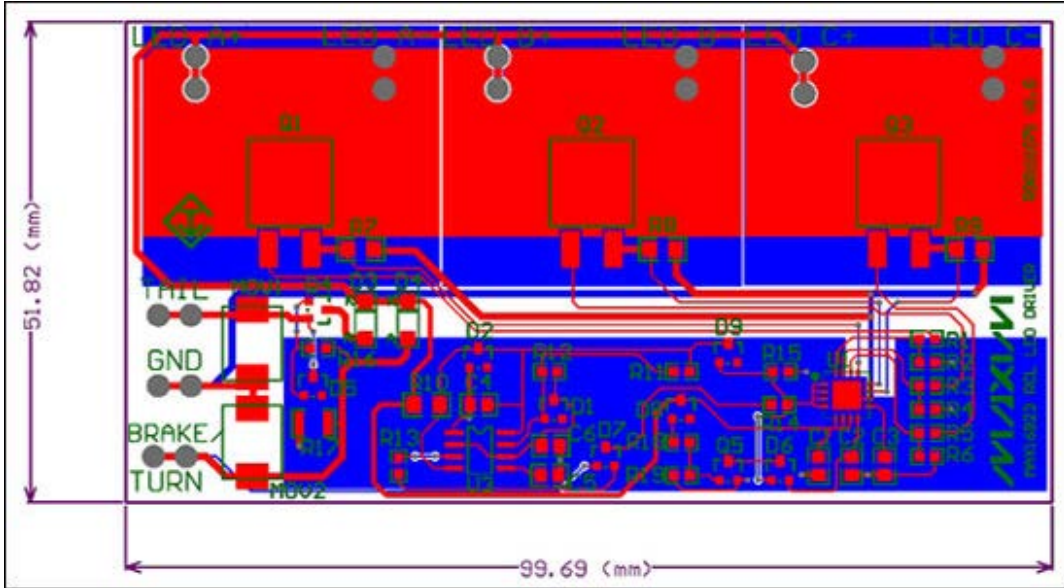

[More detailed image \(PDF, 320kB\)](#)
Figure 3. Layout of the LED driver.

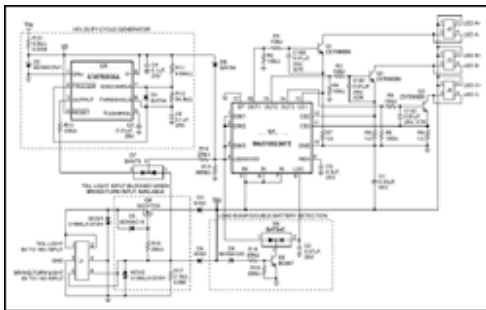

[More detailed image \(PDF, 116kB\)](#)
Figure 4. Schematic of the LED driver.

Design Analysis

The design consists of four main blocks: the input protection and input selector, the 10% duty-cycle generator, the load-dump and double-battery detection, and the LED driver circuitry.

Input Protection

Input protection is primarily provided by metal-oxide varistors MOV1 and MOV2. For this design, we have used the V18MLA1210H from Littelfuse. (Quality MOVs are also available from EPCOS.) Depending upon the environment, the MOVs may require higher or lower joule ratings.

Input Selector

The input selector is designed to pull power from the tail light when voltage is available on that node, except for when power is available from the brake/turn input. Whenever power is available from the brake/turn input, the selector actively blocks current from the tail-light input. This approach causes about 600mA to flow from the brake/turn input, which indicates a functional RCL. When a fault occurs in the LED driver or the LEDs themselves, the MAX16823 will completely turn off all the LEDs, resulting in less than 5mA of current from the brake/turn source. The lamp-outage circuitry will successfully detect this low current and will issue service-required warning flags.

The combination of D5 and R16 provide a sense circuit that enhances Q4 when the tail-light input is 9V or greater and when the brake/turn input is at ground or high impedance. This voltage is applied to D3 to supply V_{IN} , which is the main power source for the LED driver. When the brake/turn input is within 2V of the tail-light voltage, Q4 does not conduct and V_{IN} is then supplied by D4. R17 provides a 2.1k Ω resistance to ground, which guarantees the maximum impedance at this node. R17 must be a 0.5W resistor since it will dissipate 270mW during double-battery conditions (24V). *The main limitation to this circuit is the assumption that the brake/turn voltage will be within 2V of the tail-light voltage when both are active.*

10% Duty-Cycle Generator

The 10% duty-cycle generator circuit provides a square wave with a 10% duty cycle, which can be fed to the MAX16823 LED driver to dim the LEDs. This will occur whenever the tail-light source supplies the input voltage. R10 and D2 create a regulated 5.1V power supply for U3 (ICM7555ISA). R10 must be a 0.25W resistor since the power dissipation can be as high as 44mW during double-battery conditions. Timer U3 is configured as an astable oscillator with the on time determined by charging C6 through D1 and R11 ($t_{ON} = 0.693 \times R11 \times C6 = 0.418\text{ms}$ [typ]) and the off time determined by discharging C6 through R12 ($t_{OFF} = 0.693 \times R12 \times C6 = 3.8\text{ms}$ [typ]). Together, the on and off cycles result in approximately a 237Hz square wave with a 9.9% duty cycle. **Figure 5** illustrates the duty cycling.

Resistor R13 provides current limiting to reduce any EMI radiation that may occur from this switching node. Physically, R13 resides in close proximity to U3 in order to minimize any EMI. The 10% square wave couples to U1 through D7 and R14. D7 provides an ORing circuit that will allow the 10% duty cycle to propagate whenever the brake/turn input is not available. This configuration provides lower LED intensity when the tail light is the input power source. However, when the brake/turn source becomes the input, D7 will pass that voltage to the DIM1, DIM2, and DIM3 inputs, resulting in 100% LED operation (higher LED intensity). Since the LEDGOOD signal cannot exceed 6V, R14 limits the current to less than 2mA, and D9 and D2 provide voltage clamping to prevent higher voltages on that node. R15 acts as a pulldown when the voltage is not present on either anode of D7. With a 400k Ω resistance, R15 will keep the DIM node to below 0.6V with a sink current as high as 1.5 μA —well below the 0.1 μA source currents from the DIM inputs.

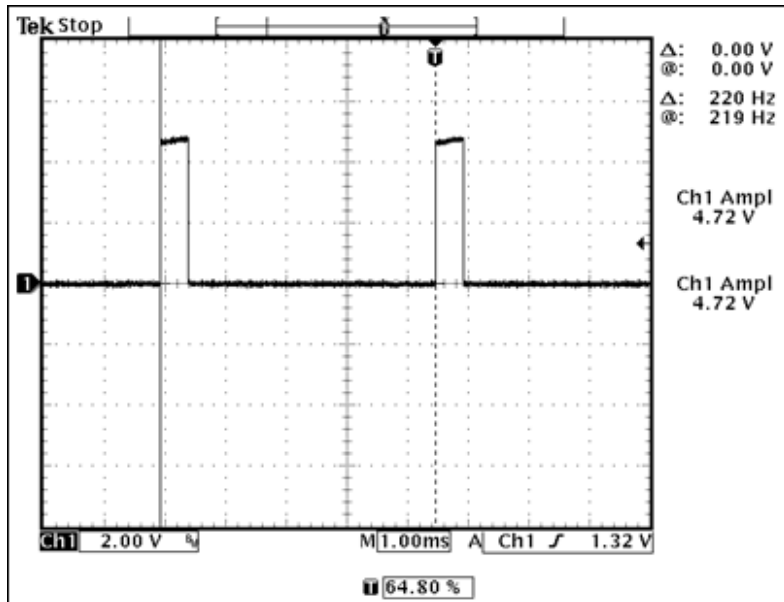

Figure 5. Oscillator output.

Load-Dump and Double-Battery Detection

The load-dump and double-battery detection circuit determines if the ORed input voltage is greater than 21V. Voltages higher than 21V indicate a load-dump condition (400ms) or a double-battery condition (unlimited time), which produce excessive dissipation in the three LED drive transistors. Therefore, the detection circuit responds by pulling the DIMx inputs low, thereby turning the output drivers off. In addition, the detection circuit pulls the LGC capacitor (C2) low in order to disable the error detection that would have occurred. Since both the DIMx and LGC pins are controlled voltages of less than 10V, the voltage rating on Q5 and D6 is not critical. The detection level is the sum of the breakdown voltage on D8 and the voltage from R18 to ground, which is approximately 22V. At 20kΩ, R9 will shunt 20μA of leakage current before turning Q5 on.

LED Driver Circuit for a 3S3P RCL

The core IC in this reference design is the MAX16823ATE LED driver, which can sustain up to 45V on its IN pins. The IC provides current from the OUTx pins to drive LEDs. Current is measured by a current-sense resistor, and the MAX16823 will adjust the current on the OUTx pins as necessary to maintain 203mV on the CS pins. Since the IC itself can only source 70mA per output, we have added an external driver to provide 200mA per LED string, as well as to dissipate the considerable heat that will result. Transistors Q1, Q2, and Q3 (ZXT690BKTC) provide the required current gain. These transistors are available in TO-262 packages, which allow for effective heat removal from the die.

Q1, Q2, and Q3 are 45V, 2A transistors that have a very low $V_{CE(Sat)}$ rating of less than 200mV with a I_C/I_B gain of 200. $V_{CE(Sat)}$ ratings are important because the difference between the minimum input voltage (9V) and the maximum LED string voltage ($3 \times 2.65V = 7.95V$) is only 1.05V. The headroom must be enough to satisfy voltage drops in Q4 and D3, as well as the $V_{CE(Sat)}$ of Q1, Q2, and Q3. See the attached [spreadsheet](#) for design details.

The resistor-divider combinations of R1/R2, R3/R4, and R5/R6 guarantee that at least 5mA is drawn from each OUTx pin to ensure IC stability. The design approach analyzes the minimum and maximum currents through the transistor base, and applies these currents to the series resistors R1, R3, and R5. The sum of the voltage drops across the resistor, the transistors' V_{BE} , and the voltage drop across the current-sense

resistors provides a voltage across R2, R4, and R6. Size these resistors such that their currents plus the base currents are at least 5mA. At the opposite end of the extreme, the OUTx currents must be less than 70mA (the rated current). See the attached spreadsheet for details.

Thermal Considerations

This design can produce up to 6W of dissipation in the pass transistors. The layout attempts to reduce the temperature rise on the transistors by connecting the transistor pad to the bottom surface of the PCB using multiple thermal vias, and passing the heat along through a electrically insulating (but thermally conducting) adhesive pad to an extruded aluminum heatsink. The heatsink has a thermal rise of about 31°C for 6W of convection. Although the Zetex transistors do not specify junction-to-case thermal resistance, other manufacturers of TO-262 packages specify it at about 3.4°C/W. This thermal resistance implies about 5.4°C of rise per transistor above the case temperature. Overall, the junction is expected to be 35°C to 40°C above ambient temperature under worst-case conditions, and, in fact, a ~30°C rise was measured on the sample board.

Transient Response

Figure 6 and Figure 7 present scope photos showing the transient response of the transistors when the tail light is the source of power. When this happens, the 10% duty-cycle oscillator pulse-width modulates the MAX16823, and the drivers turn the external transistors on and off. In Figure 6, the undershoot has a duration of about 3μs, and in Figure 7, the overshoot lasts for about 100μs. Neither was considered a problem.

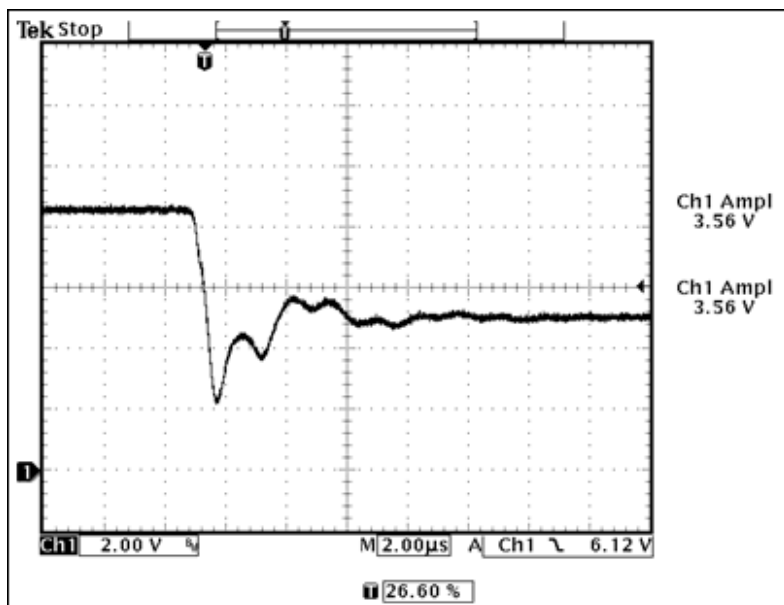

Figure 6. Transistor Q1 collector as transistor is turned on ($V_{IN} = 12.5V$).

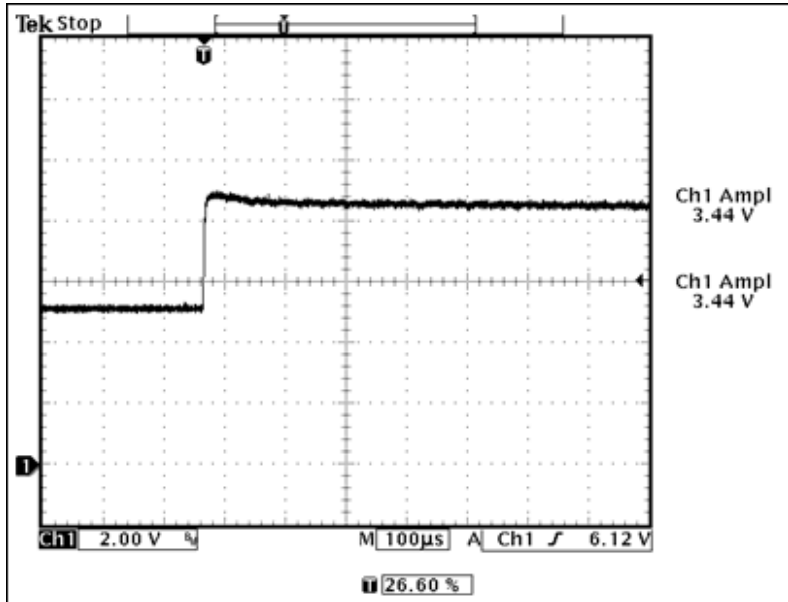

Figure 7. Transistor Q1 collector as transistor is turned off ($V_{IN} = 12.5V$).

Related Parts

ICM7555	Low-Power, General-Purpose Timer	Free Samples
MAX16823	High-Voltage, 3-Channel Linear High-Brightness LED Driver with Open LED Detection	Free Samples

More Information

For Technical Support: <http://www.maximintegrated.com/support>

For Samples: <http://www.maximintegrated.com/samples>

Other Questions and Comments: <http://www.maximintegrated.com/contact>

Application Note 4380: <http://www.maximintegrated.com/an4380>

REFERENCE DESIGN 4380, AN4380, AN 4380, APP4380, Appnote4380, Appnote 4380

Copyright © by Maxim Integrated Products

Additional Legal Notices: <http://www.maximintegrated.com/legal>