



ON Semiconductor®

NDP6020P / NDB6020P

P-Channel Logic Level Enhancement Mode Field Effect Transistor

General Description

These logic level P-Channel enhancement mode power field effect transistors are produced using ON Semiconductor's proprietary, high cell density, DMOS technology. This very high density process has been especially tailored to minimize on-state resistance, provide superior switching performance, and withstand high energy pulses in the avalanche and commutation modes. These devices are particularly suited for low voltage applications such as automotive, DC/DC converters, PWM motor controls, and other battery powered circuits where fast switching, low in-line power loss, and resistance to transients are needed.

Features

- -24 A, -20 V. $R_{DS(ON)} = 0.05 \Omega @ V_{GS} = -4.5 \text{ V}$.
 $R_{DS(ON)} = 0.07 \Omega @ V_{GS} = -2.7 \text{ V}$.
 $R_{DS(ON)} = 0.075 \Omega @ V_{GS} = -2.5 \text{ V}$.
- Critical DC electrical parameters specified at elevated temperature.
- Rugged internal source-drain diode can eliminate the need for an external Zener diode transient suppressor.
- 175°C maximum junction temperature rating.
- High density cell design for extremely low $R_{DS(ON)}$.
- TO-220 and TO-263 (D²PAK) package for both through hole and surface mount applications.



Absolute Maximum Ratings $T_C = 25^\circ\text{C}$ unless otherwise noted

| Symbol | Parameter | NDP6020P | NDB6020P | Units |
|----------------|--|----------|------------|------------------|
| V_{DSS} | Drain-Source Voltage | | -20 | V |
| V_{GSS} | Gate-Source Voltage - Continuous | | ±8 | V |
| I_D | Drain Current - Continuous | | -24 | A |
| | - Pulsed | | -70 | |
| P_D | Total Power Dissipation @ $T_C = 25^\circ\text{C}$ | | 60 | W |
| | Derate above 25°C | | 0.4 | |
| T_J, T_{STG} | Operating and Storage Temperature Range | | -65 to 175 | $^\circ\text{C}$ |

Electrical Characteristics ($T_c = 25^\circ\text{C}$ unless otherwise noted)

| Symbol | Parameter | Conditions | Min | Typ | Max | Units | |
|---|-----------------------------------|--|---------------------------|------|-------|---------------|---------------|
| OFF CHARACTERISTICS | | | | | | | |
| BV_{DSS} | Drain-Source Breakdown Voltage | $V_{GS} = 0\text{ V}, I_D = -250\ \mu\text{A}$ | -20 | | | V | |
| I_{DSS} | Zero Gate Voltage Drain Current | $V_{DS} = -16\text{ V}, V_{GS} = 0\text{ V}$ | | | -1 | μA | |
| | | | $T_J = 55^\circ\text{C}$ | | | -10 | μA |
| I_{GSSF} | Gate - Body Leakage, Forward | $V_{GS} = 8\text{ V}, V_{DS} = 0\text{ V}$ | | | 100 | nA | |
| I_{GSSR} | Gate - Body Leakage, Reverse | $V_{GS} = -8\text{ V}, V_{DS} = 0\text{ V}$ | | | -100 | nA | |
| ON CHARACTERISTICS (Note 1) | | | | | | | |
| $V_{GS(th)}$ | Gate Threshold Voltage | $V_{DS} = V_{GS}, I_D = -250\ \mu\text{A}$ | | -0.4 | -0.7 | -1 | V |
| | | | $T_J = 125^\circ\text{C}$ | -0.3 | -0.56 | -0.7 | |
| $R_{DS(on)}$ | Static Drain-Source On-Resistance | $V_{GS} = -4.5\text{ V}, I_D = -12\text{ A}$ | | | 0.041 | 0.05 | Ω |
| | | | $T_J = 125^\circ\text{C}$ | | | 0.06 | 0.08 |
| $R_{DS(on)}$ | Static Drain-Source On-Resistance | $V_{GS} = -2.7\text{ V}, I_D = -10\text{ A}$ | | | 0.059 | 0.07 | |
| $R_{DS(on)}$ | Static Drain-Source On-Resistance | $V_{GS} = -2.5\text{ V}, I_D = -10\text{ A}$ | | | 0.064 | 0.075 | |
| $I_{D(on)}$ | On-State Drain Current | $V_{GS} = -4.5\text{ V}, V_{DS} = -5\text{ V}$ | -24 | | | A | |
| g_{FS} | Forward Transconductance | $V_{DS} = -5\text{ V}, I_D = -12\text{ A}$ | | 14 | | S | |
| DYNAMIC CHARACTERISTICS | | | | | | | |
| C_{iss} | Input Capacitance | $V_{DS} = -10\text{ V}, V_{GS} = 0\text{ V},$ $f = 1.0\text{ MHz}$ | | 1590 | | pF | |
| C_{oss} | Output Capacitance | | | 725 | | pF | |
| C_{rss} | Reverse Transfer Capacitance | | | 215 | | pF | |
| SWITCHING CHARACTERISTICS (Note 1) | | | | | | | |
| $t_{D(on)}$ | Turn - On Delay Time | $V_{DD} = -20\text{ V}, I_D = -3\text{ A},$ $V_{GS} = -5\text{ V}, R_{CEV} = 6\ \Omega$ | | 15 | 30 | nS | |
| t_r | Turn - On Rise Time | | | 27 | 60 | nS | |
| $t_{D(off)}$ | Turn - Off Delay Time | | | 120 | 250 | nS | |
| t_f | Turn - Off Fall Time | | | 70 | 150 | nS | |
| Q_g | Total Gate Charge | $V_{DS} = -10\text{ V},$ $I_D = -24\text{ A}, V_{GS} = -5\text{ V}$ | | 25 | 35 | nC | |
| Q_{gs} | Gate-Source Charge | | | 5 | | nC | |
| Q_{gd} | Gate-Drain Charge | | | 10 | | nC | |

Electrical Characteristics ($T_c = 25^\circ\text{C}$ unless otherwise noted)

| Symbol | Parameter | Conditions | Min | Typ | Max | Units |
|---|---|--|-----|------|------|---------------------------|
| DRAIN-SOURCE DIODE CHARACTERISTICS | | | | | | |
| I_S | Maximum Continuous Drain-Source Diode Forward Current | | | | -24 | A |
| I_{SM} | Maximum Pulsed Drain-Source Diode Forward Current | | | | -80 | A |
| V_{SD} | Drain-Source Diode Forward Voltage | $V_{GS} = 0\text{ V}$, $I_S = -12\text{ A}$ (Note 1) | | -1.1 | -1.3 | V |
| t_{rr} | Reverse Recovery Time | $V_{GS} = 0\text{ V}$, $I_F = -24\text{ A}$, $di_F/dt = 100\text{ A}/\mu\text{s}$ | | 60 | | ns |
| I_{rr} | Reverse Recovery Current | | | -1.7 | | A |
| THERMAL CHARACTERISTICS | | | | | | |
| $R_{\theta JC}$ | Thermal Resistance, Junction-to-Case | | | | 2.5 | $^\circ\text{C}/\text{W}$ |
| $R_{\theta JA}$ | Thermal Resistance, Junction-to-Ambient | | | | 62.5 | $^\circ\text{C}/\text{W}$ |

Note:

1. Pulse Test: Pulse Width $\leq 300\ \mu\text{s}$, Duty Cycle $\leq 2.0\%$.

OBSOLETE
 THIS DEVICE IS OBSOLETE
 PLEASE CONTACT YOUR onsemi
 REPRESENTATIVE FOR INFORMATION

Typical Electrical Characteristics

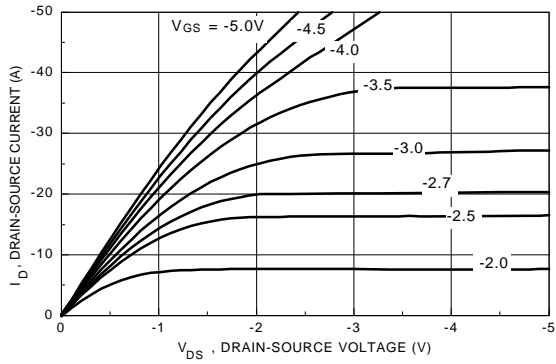

Figure 1. On-Region Characteristics.

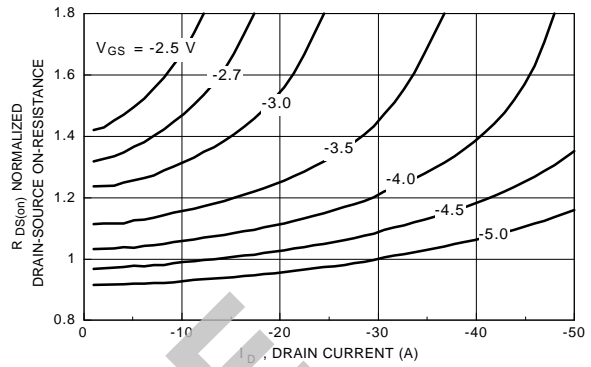

Figure 2. On-Resistance Variation with Gate Voltage and Drain Current.

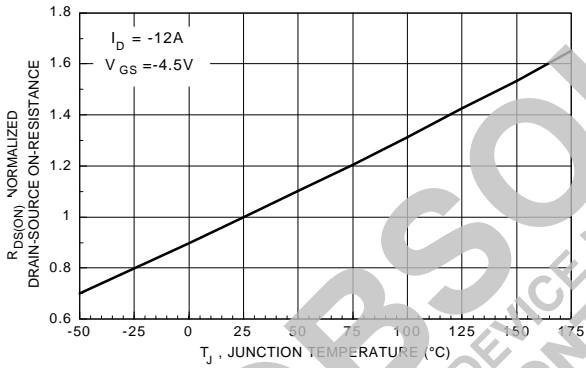

Figure 3. On-Resistance Variation with Temperature.

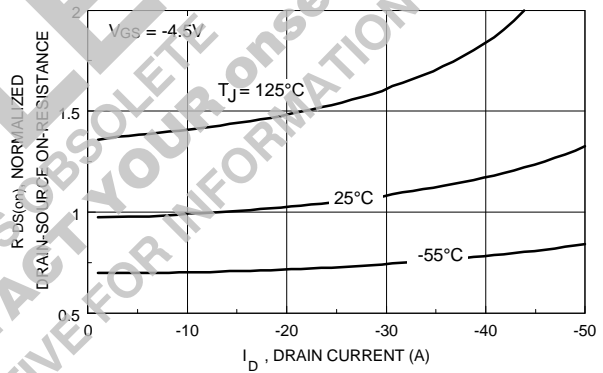

Figure 4. On-Resistance Variation with Drain Current and Temperature.

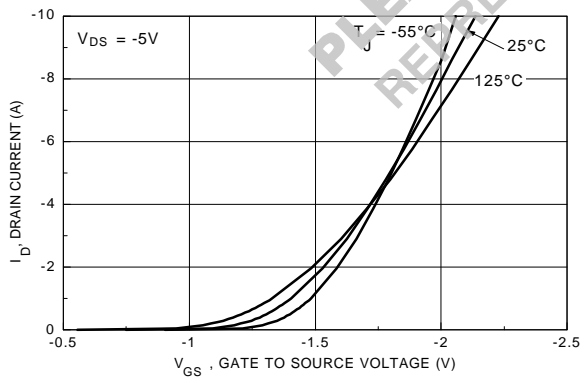

Figure 5. Transfer Characteristics.

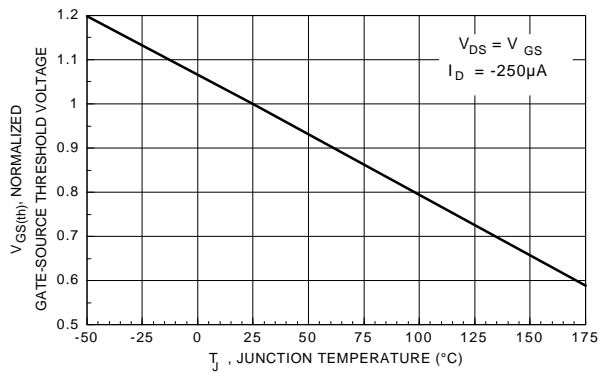

Figure 6. Gate Threshold Variation with Temperature.

Typical Electrical Characteristics (continued)

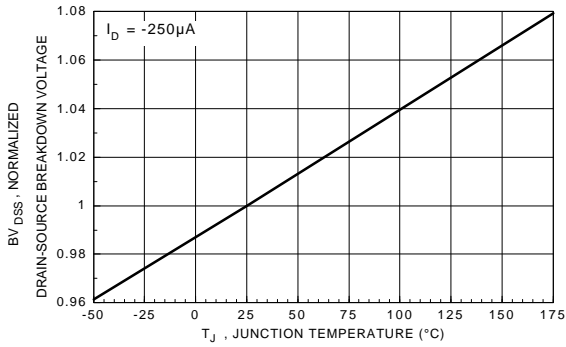

Figure 7. Breakdown Voltage Variation with Temperature.

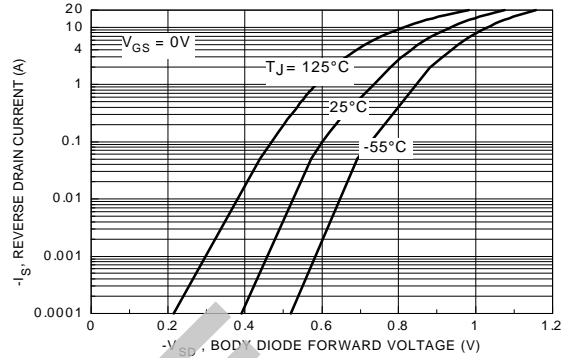

Figure 8. Body Diode Forward Voltage Variation with Current and Temperature.

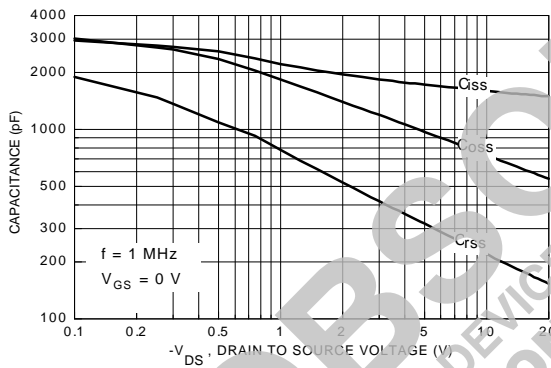

Figure 9. Capacitance Characteristics.

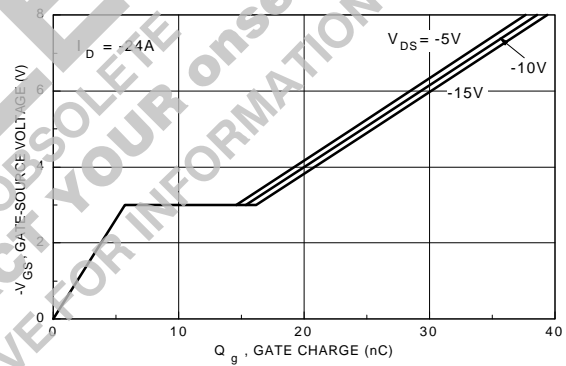

Figure 10. Gate Charge Characteristics.

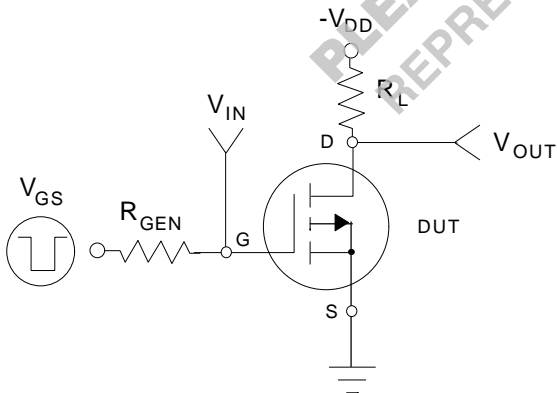

Figure 11. Switching Test Circuit.

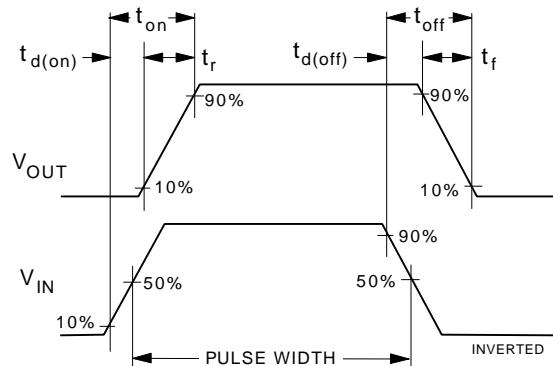

Figure 12. Switching Waveforms.

Typical Electrical Characteristics (continued)

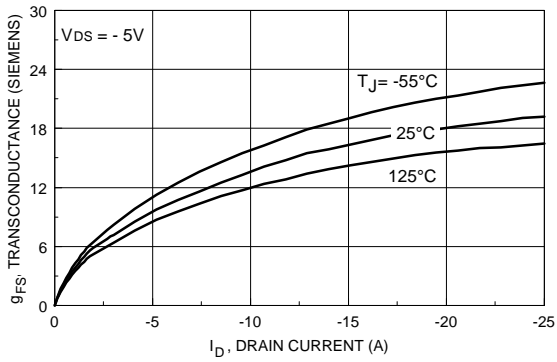

Figure 13. Transconductance Variation with Drain Current and Temperature.

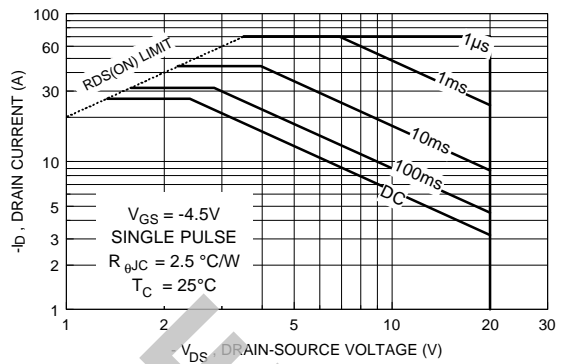

Figure 14. Maximum Safe Operating Area.

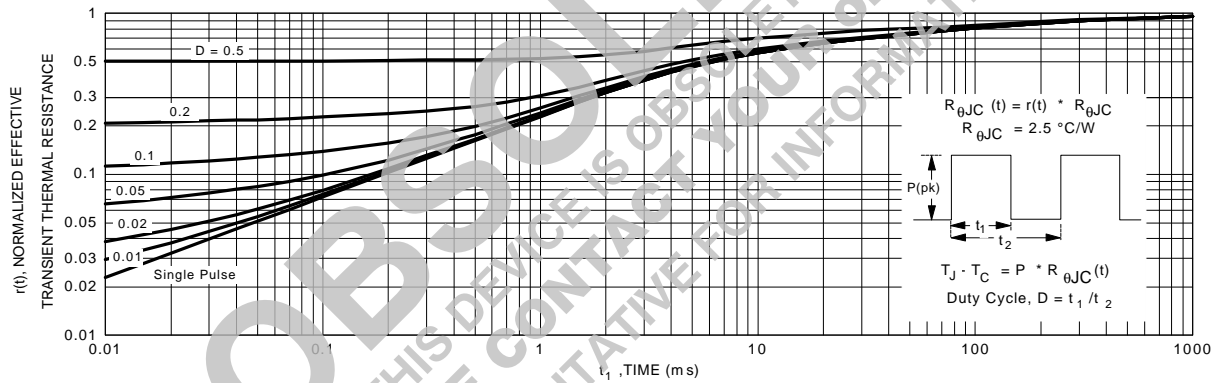



Figure 15. Transient Thermal Response Curve.

OBSOLETE
THIS DEVICE IS OBSOLETE
PLEASE CONTACT YOUR onsemi
REPRESENTATIVE FOR INFORMATION

ON Semiconductor and  are trademarks of Semiconductor Components Industries, LLC dba ON Semiconductor or its subsidiaries in the United States and/or other countries. ON Semiconductor owns the rights to a number of patents, trademarks, copyrights, trade secrets, and other intellectual property. A listing of ON Semiconductor's product/patent coverage may be accessed at www.onsemi.com/site/pdf/Patent-Marking.pdf. ON Semiconductor reserves the right to make changes without further notice to any products herein. ON Semiconductor makes no warranty, representation or guarantee regarding the suitability of its products for any particular purpose, nor does ON Semiconductor assume any liability arising out of the application or use of any product or circuit, and specifically disclaims any and all liability, including without limitation special, consequential or incidental damages. Buyer is responsible for its products and applications using ON Semiconductor products, including compliance with all laws, regulations and safety requirements or standards, regardless of any support or applications information provided by ON Semiconductor. "Typical" parameters which may be provided in ON Semiconductor data sheets and/or specifications can and do vary in different applications and actual performance may vary over time. All operating parameters, including "Typicals" must be validated for each customer application by customer's technical experts. ON Semiconductor does not convey any license under its patent rights nor the rights of others. ON Semiconductor products are not designed, intended, or authorized for use as a critical component in life support systems or any FDA Class 3 medical devices or medical devices with a same or similar classification in a foreign jurisdiction or any devices intended for implantation in the human body. Should Buyer purchase or use ON Semiconductor products for any such unintended or unauthorized application, Buyer shall indemnify and hold ON Semiconductor and its officers, employees, subsidiaries, affiliates, and distributors harmless against all claims, costs, damages, and expenses, and reasonable attorney fees arising out of, directly or indirectly, any claim of personal injury or death associated with such unintended or unauthorized use, even if such claim alleges that ON Semiconductor was negligent regarding the design or manufacture of the part. ON Semiconductor is an Equal Opportunity/Affirmative Action Employer. This literature is subject to all applicable copyright laws and is not for resale in any manner.

PUBLICATION ORDERING INFORMATION

LITERATURE FULFILLMENT:

Literature Distribution Center for ON Semiconductor
19521 E. 32nd Pkwy, Aurora, Colorado 80011 USA
Phone: 303-675-2175 or 800-344-3860 Toll Free USA/Canada
Fax: 303-675-2176 or 800-344-3867 Toll Free USA/Canada
Email: orderlit@onsemi.com

N. American Technical Support: 800-282-9855 Toll Free
USA/Canada
Europe, Middle East and Africa Technical Support:
Phone: 421 33 790 2910
Japan Customer Focus Center
Phone: 81-3-5817-1050

ON Semiconductor Website: www.onsemi.com
Order Literature: <http://www.onsemi.com/orderlit>

For additional information, please contact your local
Sales Representative