

Micro-Power Voltage Detectors with Manual Reset

General Description

The RT9817 is a micro-power voltage detector with deglitched manual reset input supervising the power supply voltage level for microprocessors (μ P) or digital systems. It provides internally fixed threshold levels with 0.1V per step ranging from 1.2V to 5V, which covers most digital applications. It features low supply current of 3 μ A. The RT9817 performs supervisory function by sending out a reset signal whenever the V_{DD} voltage falls below a preset threshold level. This reset signal will last the whole period before V_{DD} recovering. Once V_{DD} recovered upcrossing the threshold level, the reset signal will be released after a certain delay time. To pull reset signal low manually, just pull the manual reset input (MR) below the specified V_{IL} level. RT9817 is provided in SC-82 and SOT-143 packages.

Ordering Information

| | | | | | |
|--------|---|---|---|---|--------------------------------------|
| RT9817 | □ | □ | □ | □ | □ |
| | | | | | Package Type |
| | | | | | H : SOT-143 |
| | | | | | Y : SC-82 |
| | | | | | Lead Plating System |
| | | | | | P : Pb Free |
| | | | | | G : Green (Halogen Free and Pb Free) |
| | | | | | Threshold Voltage |
| | | | | | 12 : 1.2V |
| | | | | | 13 : 1.3V |
| | | | | | ⋮ |
| | | | | | 49 : 4.9V |
| | | | | | 50 : 5.0V |
| | | | | | Reset Active Timeout Period |
| | | | | | A = 0ms (RESET) |
| | | | | | B = 55ms (RESET) |
| | | | | | C = 220ms (RESET) |
| | | | | | D = 450ms (RESET) |
| | | | | | E = 0ms (RESET) |
| | | | | | F = 55ms (RESET) |
| | | | | | G = 220ms (RESET) |
| | | | | | H = 450ms (RESET) |

Note :

Richtek products are :

- ▶ RoHS compliant and compatible with the current requirements of IPC/JEDEC J-STD-020.
- ▶ Suitable for use in SnPb or Pb-free soldering processes.

Features

- Internally Fixed Threshold 1.2V to 5V in 0.1V Step
- High Accuracy $\pm 1.5\%$
- Low Supply Current 3 μ A
- No External Components Required
- Quick Reset within 20 μ s
- Built-in Recovery Delay Include 0ms, 55ms, 220ms, 450ms Options
- Low Functional Supply Voltage 0.9V
- CMOS Push-Pull Output
- Small SC-82 and SOT-143 Packages
- RoHS Compliant and 100% Lead (Pb)-Free

Applications

- Computers
- Controllers
- Intelligent Instruments
- Critical μ P and μ C Power Monitoring
- Portable/Battery-Powered Equipment

Pin Configuration

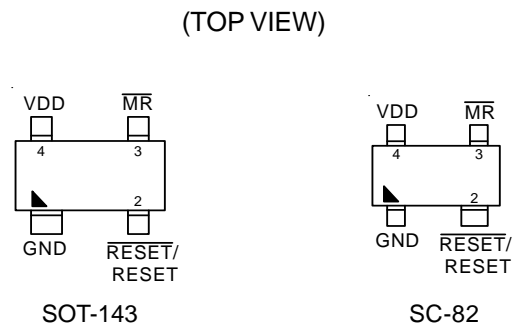

Marking Information

For marking information, contact our sales representative directly or through a RichTek distributor located in your area, otherwise visit our website for detail.

Part Status

| Part No. | Status | Package Type | Lead Plating System |
|--------------|----------|--------------|---------------------|
| RT9817B-XXPH | Obsolete | SOT-143 | Pb Free |
| RT9817B-XXPY | Obsolete | SC-82 | Pb Free |

The part status values are defined as below :

Active : Device is in production and is recommended for new designs.

Lifebuy : The device will be discontinued, and a lifetime-buy period is in effect.

NRND : Not recommended for new designs.

Preview : Device has been announced but is not in production.

Obsolete : Richtek has discontinued the production of the device.

Typical Application Circuit

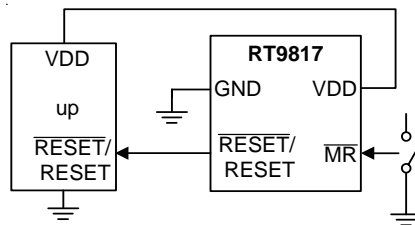

Functional Pin Description

| Pin Name | Pin Function |
|---------------------------|------------------------------------|
| GND | Ground Pin |
| $\overline{\text{RESET}}$ | Active Low Push-Pull Reset Output |
| RESET | Active High Push-Pull Reset Output |
| $\overline{\text{MR}}$ | Manual Reset |
| VDD | Power Pin |

Functional Block Diagram

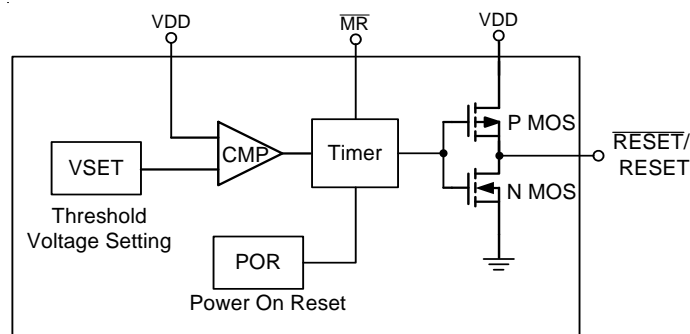

Absolute Maximum Ratings (Note 1)

- Terminal Voltage (with Respect to GND)
 - V_{DD} ----- -0.3V to 6.0V
- All Other Inputs ----- -0.3V to $V_{DD}+0.3V$
- Input Current, I_{VDD} ----- 20mA
- Power Dissipation, PD @ $T_A = 25^\circ C$
 - SC-82 ----- 0.25W
 - SOT-143 ----- 0.285W
- Package Thermal Resistance (Note 2)
 - SC-82, θ_{JA} ----- $400^\circ C$
 - SOT-143, θ_{JA} ----- $350^\circ C$
- Lead Temperature (Soldering, 10sec.) ----- $260^\circ C$
- Storage Temperature Range ----- $-65^\circ C$ to $125^\circ C$
- ESD Susceptibility (Note 3)
 - HBM (Human Body Mode) ----- 2kV
 - MM (Machine Mode) ----- 200V

Recommended Operating Conditions (Note 4)

- Junction Temperature Range ----- $-40^\circ C$ to $125^\circ C$
- Ambient Temperature Range ----- $-40^\circ C$ to $85^\circ C$

Electrical Characteristics

($V_{DD} = 3V$, $T_A = 25^\circ C$, unless otherwise specified)

| Parameter | Symbol | Test Conditions | Min | Typ | Max | Unit | |
|--|-----------------|--|----------------------------------|---------------|------|---------|----|
| Operating V_{DD} (V_{OUT}) Range | V_{DD} | RT9817A/B/C/D | 0.9 | -- | 6 | V | |
| | | RT9817E/F/G/H | 1.1 | -- | 6 | | |
| Supply Current | I_{DD} | $V_{TH} = 3V$, $V_{DD} = 4.5V$ | -- | 3 | 8 | μA | |
| Reset Threshold | V_{TH} | | -- | 1.2 to 5.0 | -- | V | |
| Threshold Voltage Accuracy | ΔV_{TH} | | -1.5 | -- | +1.5 | % | |
| Threshold Voltage Hysteresis | V_{HYS} | | -- | $0.01 V_{TH}$ | -- | V | |
| V_{DD} Drop to Reset Delay | t_{RD} | Drop = $V_{TH} - 125mV$ | -- | 20 | -- | μs | |
| Reset Active Time Out Period | RT9817A/E | t_{RP} | $V_{DD} \geq 1.02 \times V_{TH}$ | -- | 0 | -- | ms |
| | RT9817B/F | | | 35 | 55 | 75 | ms |
| | RT9817C/G | | | 143 | 220 | 297 | ms |
| | RT9817D/H | | | 292 | 450 | 608 | ms |
| \overline{RESET} Output Voltage Low | V_{OL} | $V_{DD} < V_{TH(MIN)}$, $I_{SINK} = 3.5mA$, $V_{TH} \geq 3V$ | -- | -- | 0.4 | V | |
| | | $V_{DD} < V_{TH(MIN)}$, $I_{SINK} = 1.2mA$, $V_{TH} \geq 1.8V$ | -- | -- | 0.3 | | |
| | | $V_{TH(MIN)} > V_{DD} > 1V$, $I_{SINK} = 0.5mA$ | -- | -- | 0.3 | | |

To be continued

| Parameter | Symbol | Test Conditions | Min | Typ | Max | Unit |
|---------------------------|-----------------|---|-----------------------|-----|-----|------|
| RESET Output Voltage High | V _{OH} | V _{DD} > V _{TH(MAX)} , I _{SOURCE} = 800μA, V _{TH} ≥ 3V | V _{DD} - 1.5 | -- | -- | V |
| | | V _{DD} > V _{TH(MAX)} , I _{SOURCE} = 500μA, V _{TH} ≥ 1.8V | 0.8 V _{DD} | -- | -- | |
| | | V _{DD} > V _{TH(MAX)} , I _{SOURCE} = 200μA, V _{TH} ≥ 1.1V | 0.8 V _{DD} | -- | -- | |
| RESET Output Voltage Low | V _{OL} | V _{DD} > V _{TH(MAX)} , I _{SINK} = 3.5mA, V _{TH} ≥ 3V | -- | -- | 0.4 | V |
| | | V _{DD} > V _{TH(MAX)} , I _{SINK} = 1.2mA, V _{TH} ≥ 1.8V | -- | -- | 0.3 | |
| | | V _{DD} > V _{TH(MAX)} , I _{SINK} = 0.5mA, V _{TH} ≥ 1.2V | -- | -- | 0.3 | |
| RESET Output Voltage High | V _{OH} | 1.1V < V _{DD} < V _{TH(MIN)} , I _{SOURCE} = 200μA | 0.8 V _{DD} | -- | -- | V |
| | | 1.8V < V _{DD} < V _{TH(MIN)} , I _{SOURCE} = 500μA | 0.8 V _{DD} | -- | -- | |
| | | 3V < V _{DD} < V _{TH(MIN)} , I _{SOURCE} = 800μA | V _{DD} - 1.5 | -- | -- | |

Note 1. Stresses listed as the above “Absolute Maximum Ratings” may cause permanent damage to the device. These are for stress ratings. Functional operation of the device at these or any other conditions beyond those indicated in the operational sections of the specifications is not implied. Exposure to absolute maximum rating conditions for extended periods may remain possibility to affect device reliability.

Note 2. θ_{JA} is measured in the natural convection at T_A = 25°C on a low effective thermal conductivity test board of JEDEC 51-3 thermal measurement standard.

Note 3. Devices are ESD sensitive. Handling [precautions](#) are recommended.

Note 4. The device is not guaranteed to function outside its operating conditions.

Typical Operating Characteristics

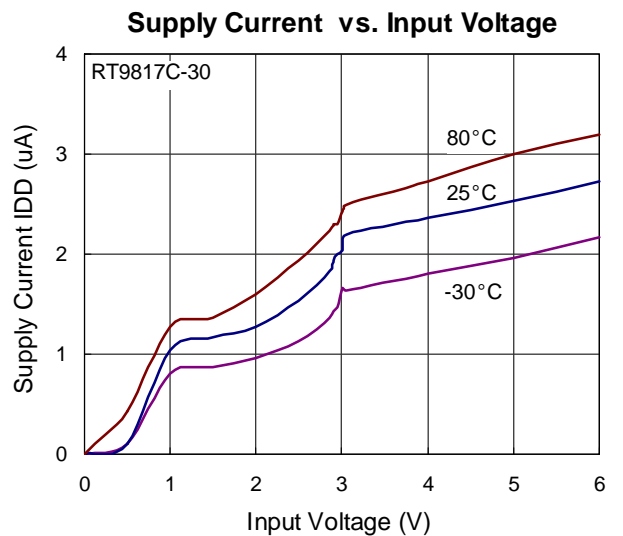
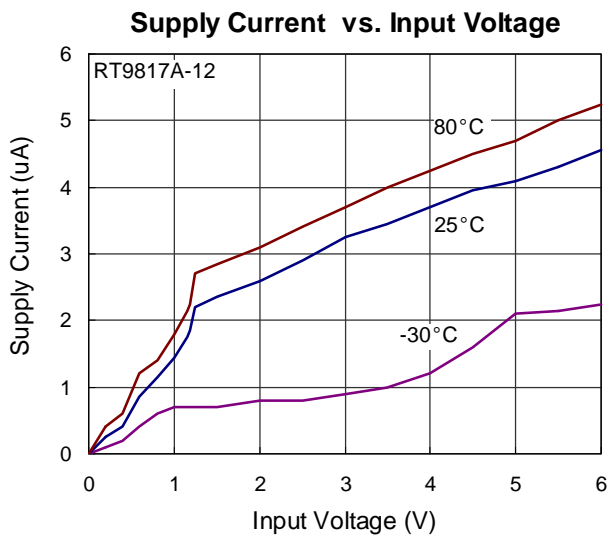
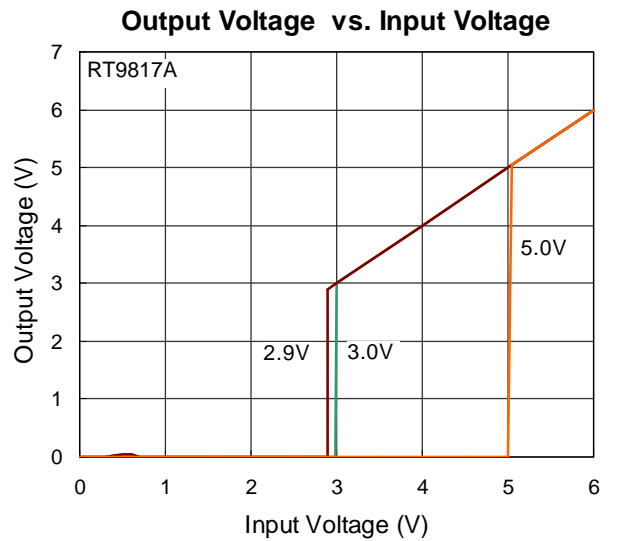
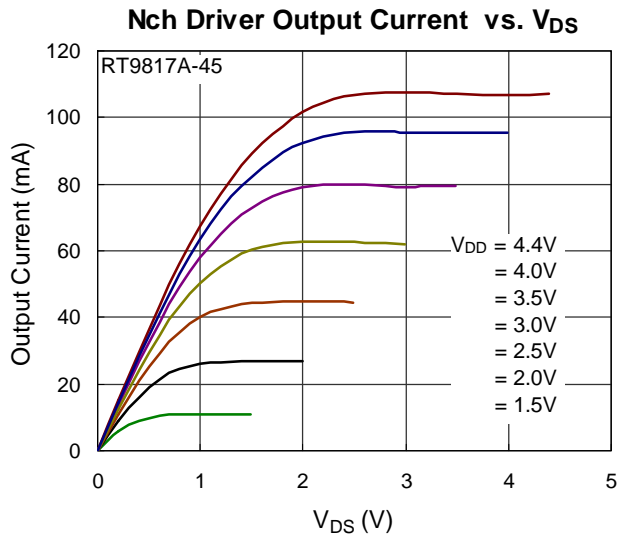
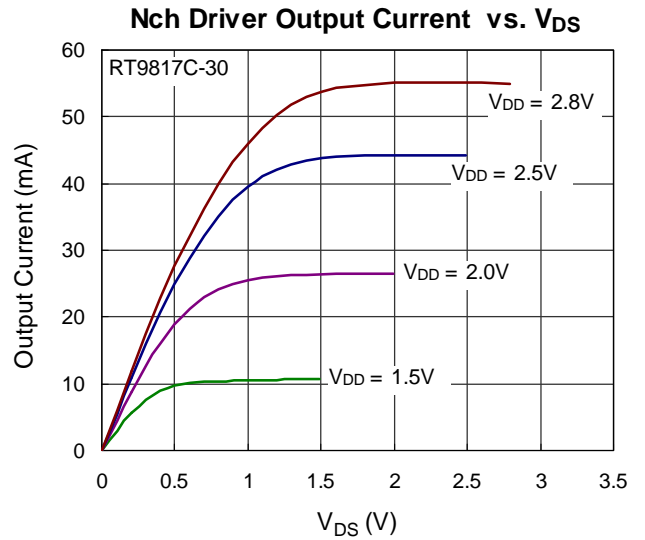
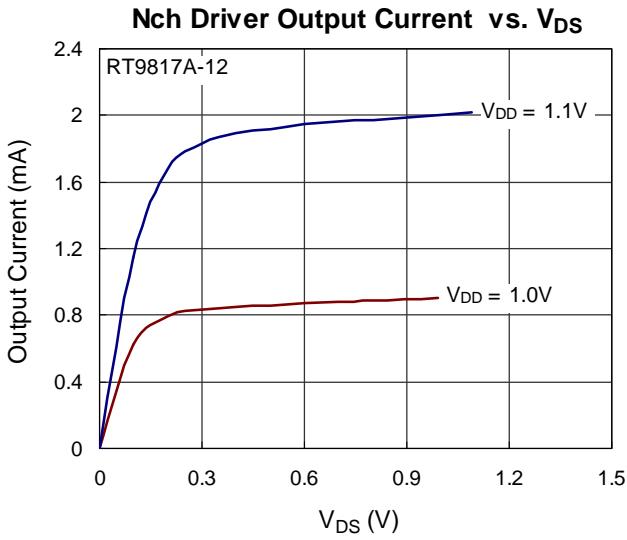

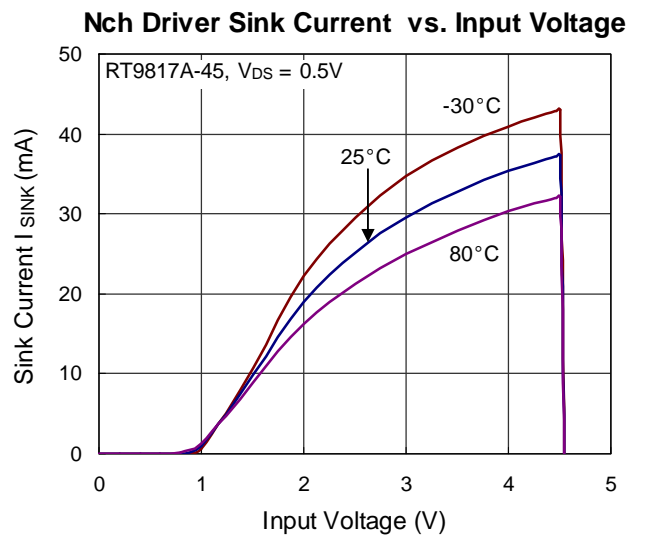
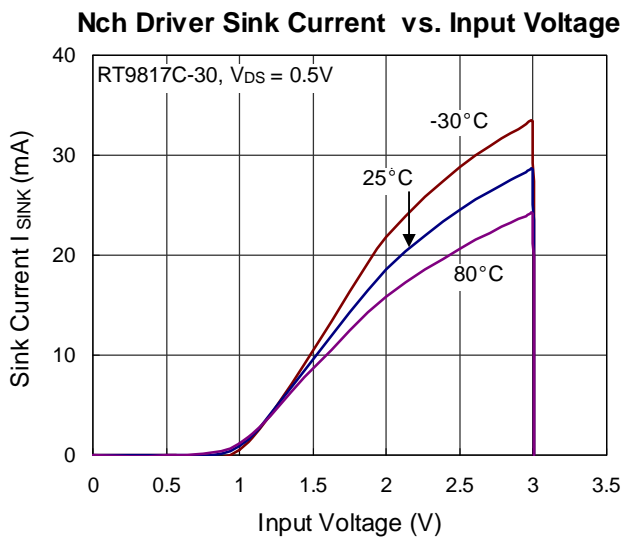
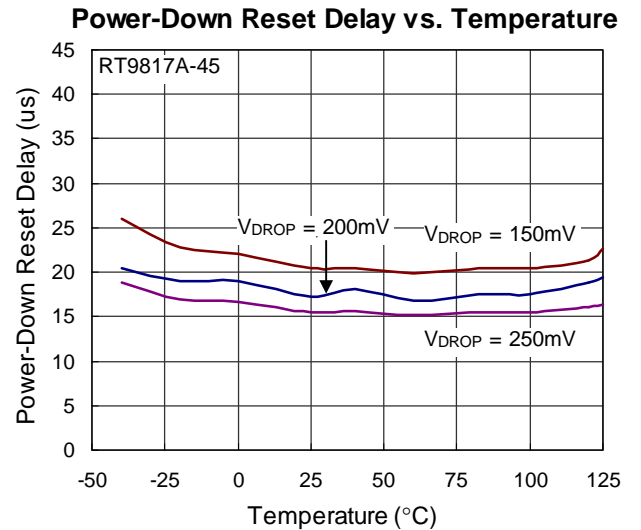
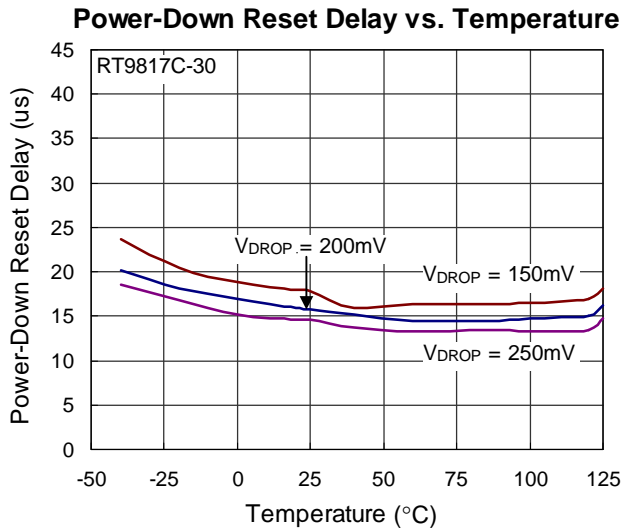
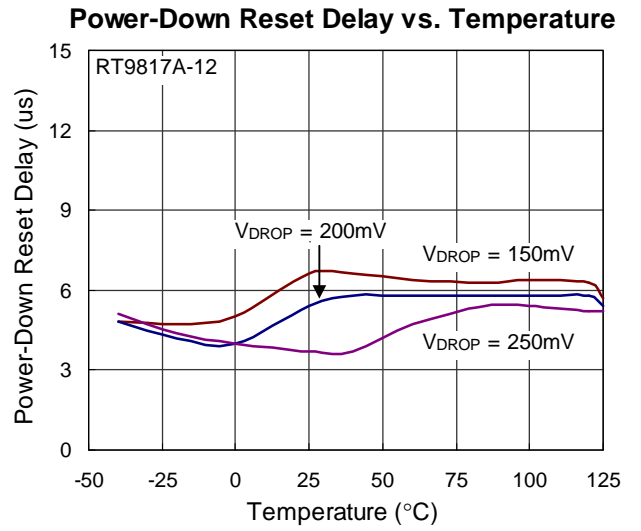
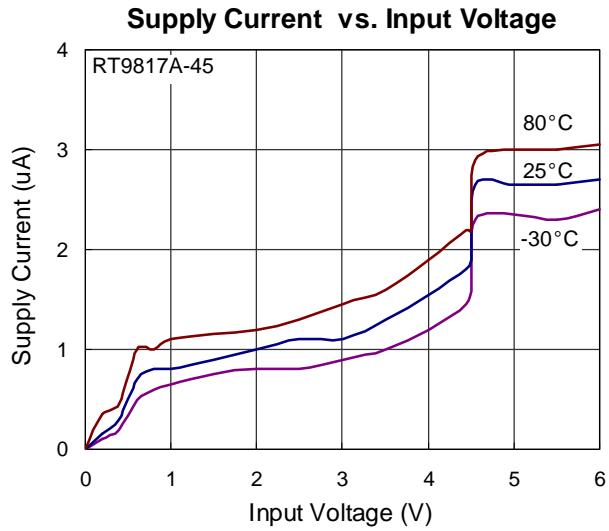

Reset Threshold Deviation vs. Temperature

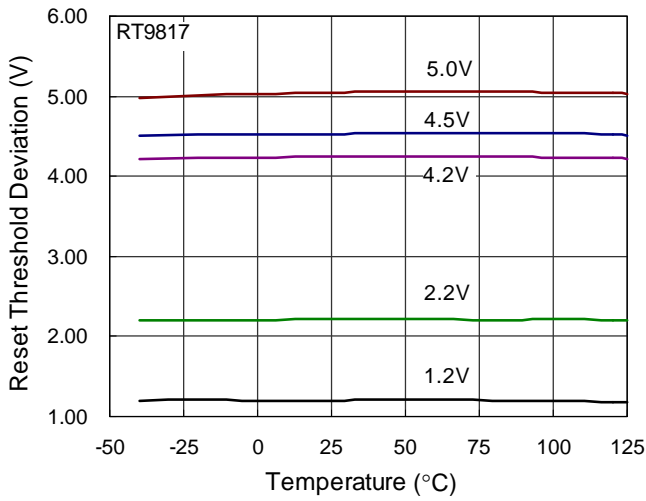

Pch Driver Output Current vs. Input Voltage

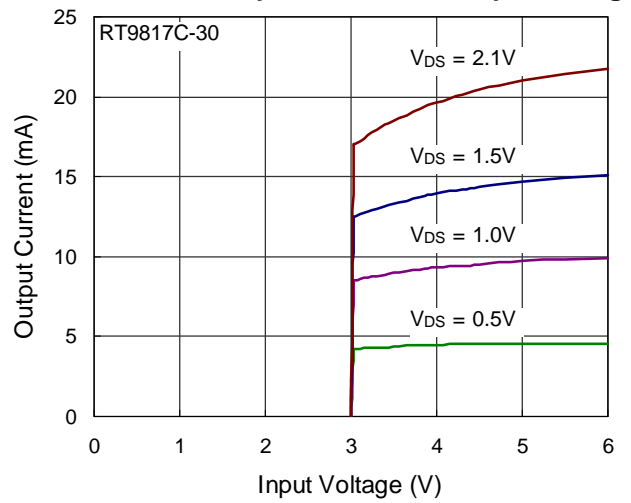

Power-Up Reset Time-Out vs. Temperature

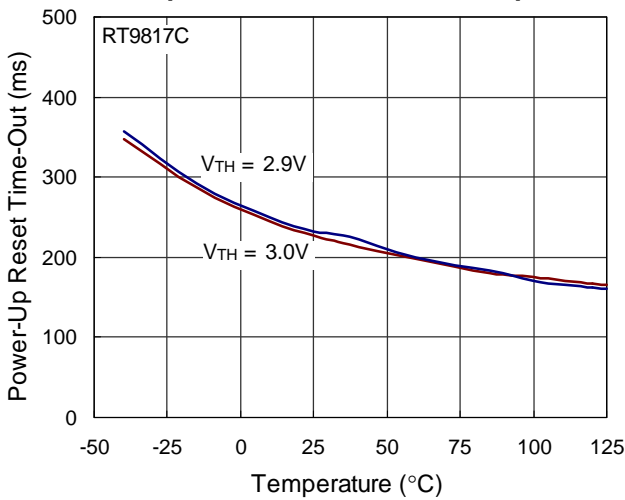

Power-Up Reset Time-Out vs. Temperature

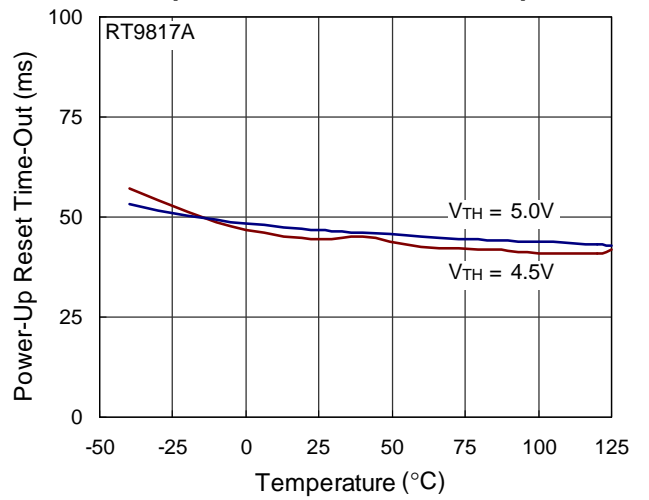

Output Delay Time vs. Load Capacitance

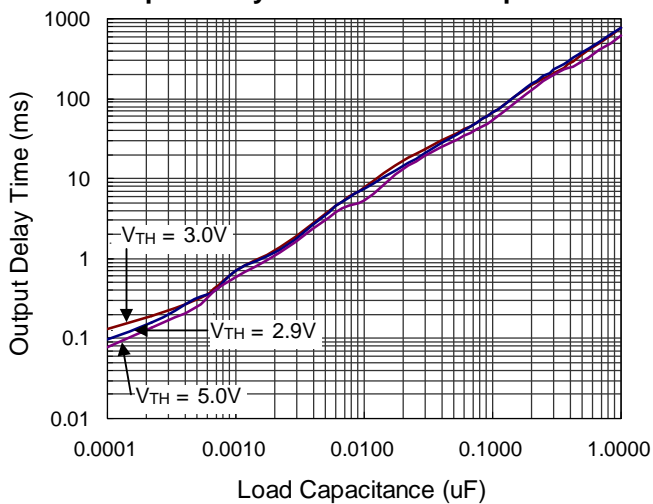

Nch Driver Output Current vs. VDS

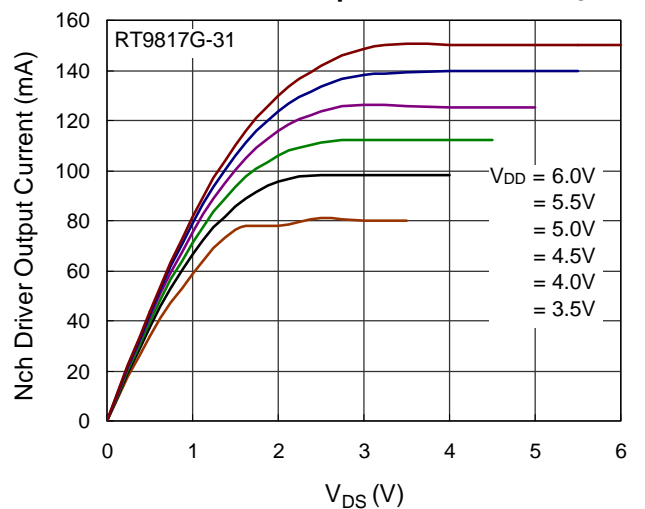

Nch Driver Output Current vs. Input Voltage

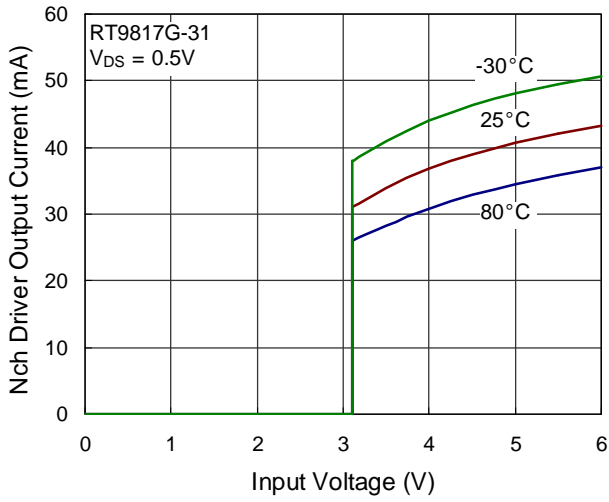

Power Down Reset Time-Out vs. Temperature

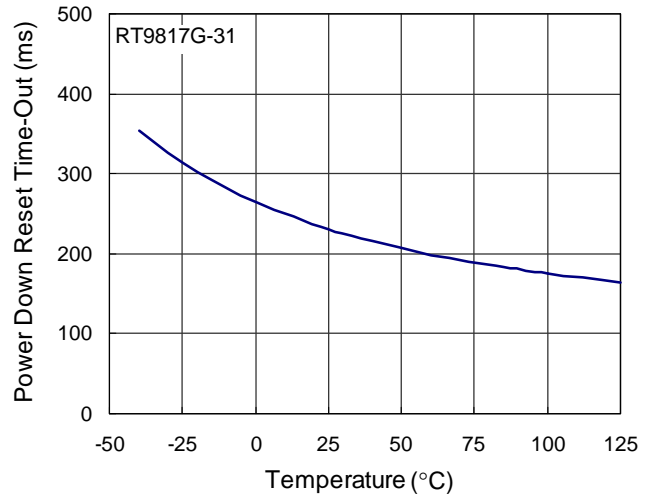

Output Voltage vs. Input Voltage

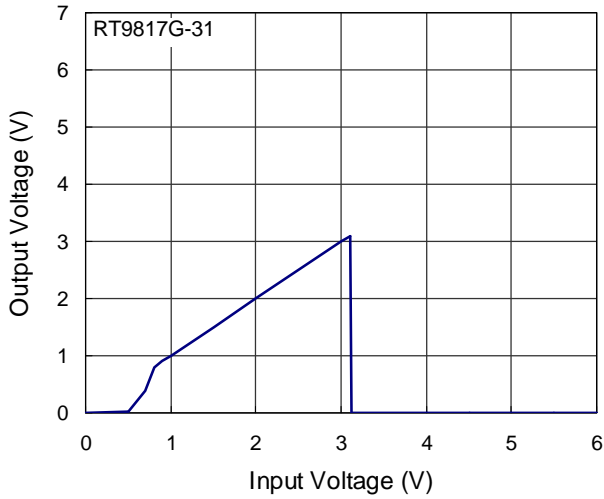

Power-Down Reset Time-Out vs. Temperature

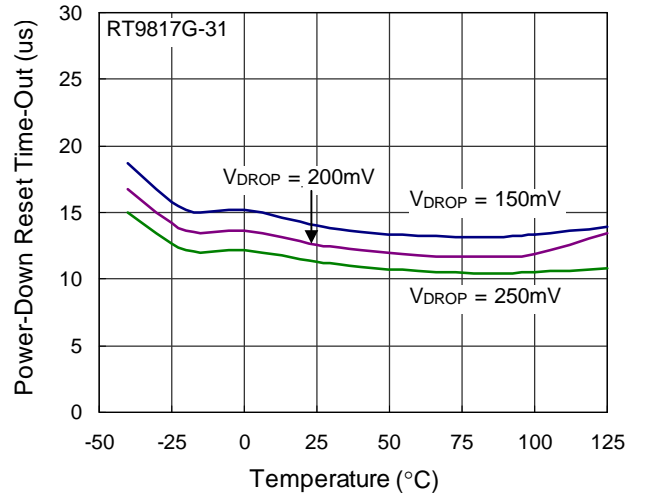

Application Information

Benefits of Highly Accurate Reset Threshold

Most μ P supervisor ICs have reset threshold voltages between 1% and 1.5% below the value of nominal supply voltages. This ensures a reset will not occur within 1% of the nominal supply, but will occur when the supply is 1.5% below nominal.

Outline Dimension

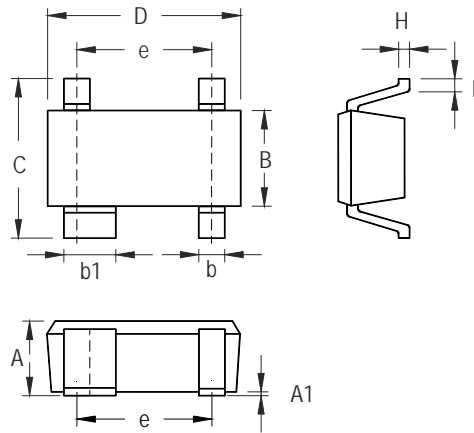

| Symbol | Dimensions In Millimeters | | Dimensions In Inches | |
|--------|---------------------------|-------|----------------------|-------|
| | Min | Max | Min | Max |
| A | 0.800 | 1.200 | 0.031 | 0.047 |
| A1 | 0.050 | 0.150 | 0.002 | 0.006 |
| B | 1.200 | 1.400 | 0.047 | 0.055 |
| b | 0.300 | 0.520 | 0.012 | 0.020 |
| b1 | 0.760 | 0.920 | 0.030 | 0.036 |
| C | 2.100 | 2.640 | 0.083 | 0.104 |
| D | 2.800 | 3.040 | 0.110 | 0.120 |
| e | 1.900 | | 0.075 | |
| H | 0.080 | 0.150 | 0.003 | 0.006 |
| L | 0.210 | 0.410 | 0.008 | 0.016 |

SOT-143 Surface Mount Package

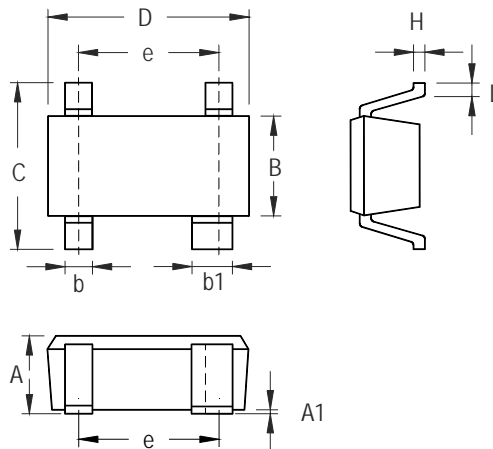

| Symbol | Dimensions In Millimeters | | Dimensions In Inches | |
|--------|---------------------------|-------|----------------------|-------|
| | Min | Max | Min | Max |
| A | 0.800 | 1.100 | 0.031 | 0.043 |
| A1 | 0.000 | 0.100 | 0.000 | 0.004 |
| B | 1.150 | 1.350 | 0.045 | 0.053 |
| b | 0.150 | 0.400 | 0.006 | 0.016 |
| b1 | 0.350 | 0.500 | 0.014 | 0.020 |
| C | 1.800 | 2.450 | 0.071 | 0.096 |
| D | 1.800 | 2.200 | 0.071 | 0.087 |
| e | 1.300 | | 0.051 | |
| H | 0.080 | 0.260 | 0.003 | 0.010 |
| L | 0.200 | 0.460 | 0.008 | 0.018 |

SC-82 Surface Mount Package

Richtek Technology Corporation

Headquarter
 5F, No. 20, Taiyuen Street, Chupei City
 Hsinchu, Taiwan, R.O.C.
 Tel: (8863)5526789 Fax: (8863)5526611

Richtek Technology Corporation

Taipei Office (Marketing)
 5F, No. 95, Minchiuan Road, Hsintien City
 Taipei County, Taiwan, R.O.C.
 Tel: (8862)86672399 Fax: (8862)86672377
 Email: marketing@richtek.com



Information that is provided by Richtek Technology Corporation is believed to be accurate and reliable. Richtek reserves the right to make any change in circuit design, specification or other related things if necessary without notice at any time. No third party intellectual property infringement of the applications should be guaranteed by users when integrating Richtek products into any application. No legal responsibility for any said applications is assumed by Richtek.