

FPF2498

Adjustable OVP with 28 V Input OVT Load Switch

Description

The FPF2498 advanced load-management switch targets applications requiring a highly integrated solution. It disconnects loads powered from the DC power rail (< 12 V) with stringent off-state current targets and high load capacitances (< 100 mF). The FPF2498 consists of a slew-rate controlled low-impedance MOSFET switch. FPF2498 has over-voltage protection and over-temperature protection.

Applications

- Cellular Phones, Smart Phones
- Tablets

Related Resources

- FPF2498 Evaluation Board

Features

Function	Advanced Load Switch
Input	3.5 – 12 V
Features	28 V Absolute Ratings on VIN 1.7 A Maximum Continuous Current Capability 80 mΩ RON Typical Over-Voltage Protection (OVP) Over-Current Protection (OCP) Thermal Shutdown Under-Voltage Lockout (UVLO) Reverse Current Blocking (RCB)
ESD	15 kV IEC 61000-4-2 Air Gap
Operating Temperature Range	-40 to +85 °C
Package	6-Ball WLCSP (1.30 x 1.05 x 0.586 mm, 0.4 mm Pitch)
Ordering Information	FPF2498BUCX
Top Mark	TK



ON Semiconductor®

www.onsemi.com

WLCSP6 1.30x1.05x0.586
CASE 567RT

ORDERING INFORMATION

See detailed ordering and shipping information in the package dimensions section on page 6 of this data sheet.

FPF2498

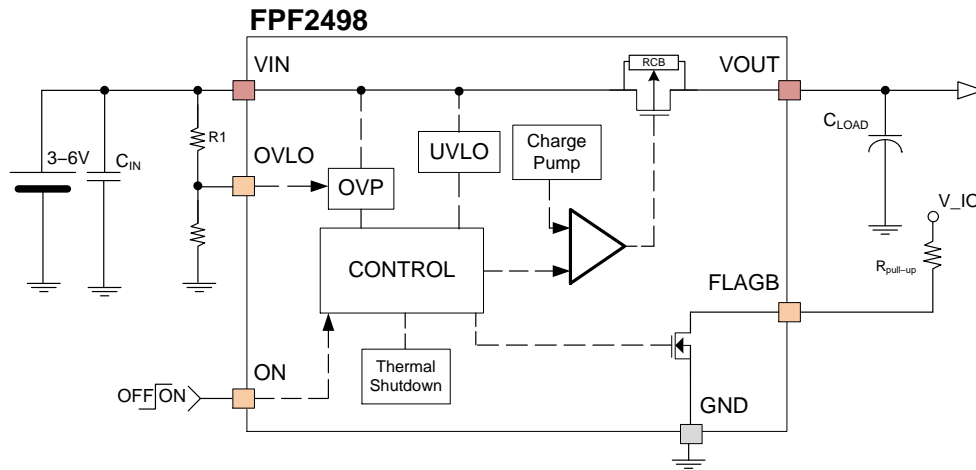

NOTE: Recommend C_{LOAD} value be larger than 2.2 μF .

Figure 1. Block Diagram and Typical Application

PIN CONFIGURATION

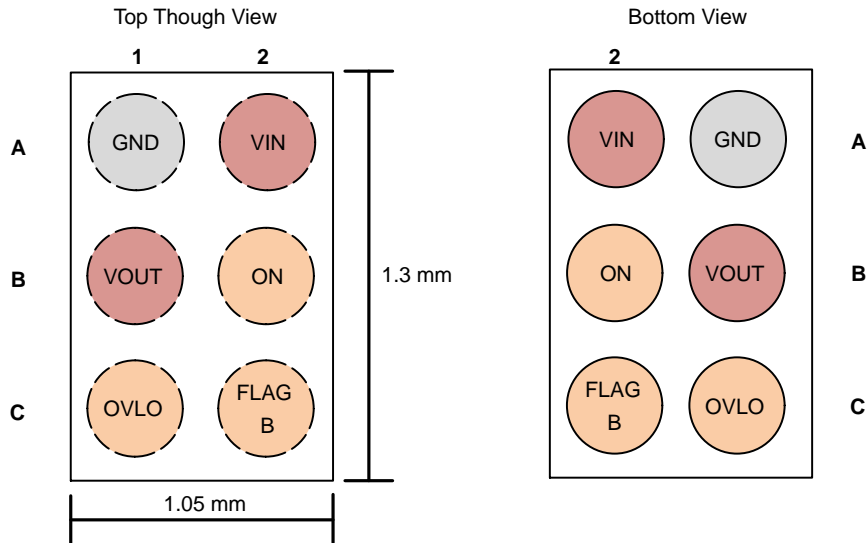

Figure 2. Pin Assignments

Table 1. PIN MAP

Name	Pin #	Type	Default State	Description		
VIN	A2	Input	N/A	Input voltage path		
VOUT	B1	Output	N/A	Output voltage path		
ON	B2	Input	LOW	On / Off control of device		$V_{IH}=HIGH$ Enabled
						$V_{IL}=LOW$ Disabled
OVLO	C1	Input		OVP Adjustment set by R1 and R2 and is compared to 1.2 V		
FLAGB	C2	Open- Drain Output	High-Z	Indicates a OVP / OCP / OTP fault		LOW / GND Active - Indicates: OVP (over 6.5 V at 3 - 6 V) OCP (over 2 A) OTP (over 150°C)
						HIGH / V_IO Normal Operation
GND	A1	GND	GND	Device ground		

FPF2498

Table 2. ABSOLUTE MAXIMUM RATINGS

Symbol	Parameters		Min.	Max.	Unit
V _{PIN}	Voltage on VIN to GND, VIN to VOUT, OVLO Pins		-0.3	28.0	V
	Voltage on ON, FLAGB Pins		-0.3	6.0	
	Voltage on VOUT to GND Pins		-0.3	20.0	
I _{SW}	Maximum Switch Current			1.75	A
t _{PD}	Total Power Dissipation at T _A = 25°C			1	W
T _J	Operating Junction Temperature		-40	+150	°C
T _{STG}	Storage Junction Temperature		-65	+150	°C
Θ _{JA}	Thermal Resistance, Junction-to-Ambient (1-inch Square Pad of 2 oz. Copper)			95 ⁽¹⁾	°C/W
				110 ⁽²⁾	
ESD	Electrostatic Discharge Capability	Human Body Model, ANSI / ESDA / JEDEC JS-001-2012	3		kV
		Charged Device Model, JESD22-C101	2		
	IEC61000-4-2 System Level	Air Discharge (V _{IN} , V _{ON} , V _{OUT} to GND)	15		
		Contact Discharge (V _{IN} , V _{ON} , V _{OUT} to GND)	8		

Stresses exceeding those listed in the Maximum Ratings table may damage the device. If any of these limits are exceeded, device functionality should not be assumed, damage may occur and reliability may be affected.

1. Measured using 2S2P JEDEC std. PCB.
2. Measured using 2S2P JEDEC PCB cold plate method.

Table 3. RECOMMENDED OPERATING CONDITIONS

Symbol	Parameters	Min.	Max.	Unit
V _{IN}	Supply Voltage	3.5	12.0	V
I _{SW}	Maximum Continuous Switch Current (Note 3)		1.7	A
T _A	Ambient Operating Temperature	-40	85	°C

Functional operation above the stresses listed in the Recommended Operating Ranges is not implied. Extended exposure to stresses beyond the Recommended Operating Ranges limits may affect device reliability.

3. Maximum Junction Temperature = 85°C

Table 4. ELECTRICAL CHARACTERISTICS

Unless otherwise noted; V_{IN}=3.5 to 5.5 V, T_A = -40 to +85°C; typical values are at V_{IN} = 5 V and T_A = 25°C.

Symbol	Parameter	Conditions	Min.	Typ.	Max.	Unit
Basic Operation						
I _{SD(OFF)}	Shutdown Current	V _{IN} = 5.5 V, V _{OUT} = 0 V, V _{ON} = GND		0.4	3.0	μA
I _Q	Quiescent Current	V _{IN} = 5.5 V, V _{OUT} = Floating, I _{OUT} = 0 mA		90	125	μA
R _{ON}	On Resistance	V _{IN} = 3.7 V, I _{OUT} = 200 mA		90		mΩ
		V _{IN} = 5.0 V, I _{OUT} = 200 mA		80	95 ⁽⁵⁾	
		V _{IN} = 9 V, I _{OUT} = 200 mA				
		V _{IN} = 12 V, I _{OUT} = 200 mA				
V _{IH}	ON Input Logic HIGH Voltage	V _{IN} = 3.5 V to 5.5 V	1.15			V
V _{IL}	ON Input Logic LOW Voltage	V _{IN} = 3.5 V to 5.5 V			0.65	V
V _{OL_FLAG}	FLAGB Output Logic LOW Voltage	V _{IN} = 5 V, I _{SINK} = 1 mA		0.10	0.20	V
I _{FLAGB_LK}	FLAGB Output HIGH Leakage Current	V _{IN} = 5 V, Switch On			0.5	μA
RPD	Pull-Down Resistance on ON Pin	V _{IN} = 5 V, OVLO = GND		3		MΩ

FPF2498

Table 4. ELECTRICAL CHARACTERISTICS

Unless otherwise noted; $V_{IN}=3.5$ to 5.5 V, $T_A = -40$ to $+85^\circ\text{C}$; typical values are at $V_{IN} = 5$ V and $T_A = 25^\circ\text{C}$.

Symbol	Parameter	Conditions	Min.	Typ.	Max.	Unit
Over-Voltage Protection						
V_{OV_TRIP}	Default Input OVP Lockout	V_{IN} Rising Threshold OVLO = GND	6.2	6.5	6.8	V
		V_{IN} Falling Threshold OVLO = GND		6.2		
V_{OVLO_SEL}	Voltage threshold for OVLO selection	$V_{IN} = 3.5$ V to 5.5 V, OVLO = GND		0.3		V
V_{OVP_HYS}	Input OVP Hysteresis	V_{IN} Falling Threshold OVLO = External Setting		0.3		V
V_{OVLO_TH}	OVLO Set Threshold	$V_{IN} = 3.5$ to V_{OVLO}		1.20		V
t_{OVP}	Response Time	$I_{OUT} = 0.5$ A, $C_L = 0$ μF , $T_A = 25^\circ\text{C}$, $V_{IN} = 6$ V to 7 V		0.5	1	μs
V_{UVLO}	Under-Voltage Lockout	V_{IN} Rising		3.2		V
		V_{IN} Falling		3.0		
V_{UVLO_HYS}	UVLO Hysteresis			200		mV
I_{RCB}	RCB Current	$V_{ON} = 0$ V, $V_{OUT} = 5.5$ V, $V_{IN} = 0$ V		2	5	μA
TSD	Thermal Shutdown	Shutdown Threshold		150		$^\circ\text{C}$
		Return from Shutdown		130		
		Hysteresis		20		

Over-Current Protection

I_{OCP}	Over-Current Protection Trip Point	$I_{SW} > I_{OCP}$		2		A
-----------	------------------------------------	--------------------	--	---	--	---

Dynamic Characteristics

t_{DON}	Turn-On Delay ⁽⁶⁾	$V_{IN} = 5$ V, $R_L = 100$ Ω , $C_L = 10$ μF , $T_A = 25^\circ\text{C}$		4.3		ms
t_R	V_{OUT} Rise Time ⁽⁶⁾			3.0		ms
t_{ON}	Turn-On Time ⁽⁷⁾			7.3		ms
t_{DOFF}	Turn-Off Delay ^(5, 6)			600		μs
t_F	V_{OUT} Fall Time ^(5, 6)			2.0		ms
t_{OFF}	Turn-Off Time ^(7, 8)			2.5		ms
t_{READY}	Time for Device Ready for Large Load Current ⁽⁹⁾	$C_L = 10$ μF		5		ms
$t_{RESTART}$	Over-Current Blanking Time ⁽⁵⁾	$V_{IN} = 5$ V $I_{OUT} \geq 1.7$ A		64		ms
t_{OCP}	Over-Current Response Time ⁽⁵⁾	Moderate Over-Current Condition; $I_{OUT} \geq I_{LIM}$ $V_{OUT} \leq V_{IN}$		4		μs
t_{HOCP}	Hard Over-Current Response Time	Moderate Over-Current Condition; $I_{OUT} \geq I_{LIM}$ $V_{OUT} \leq 0$ V		3		μs
$t_{FLAGB_Release}$	Over-Current/Voltage/Temp. Flag Release Time ⁽⁵⁾	Time for Flag to Release when Fault Condition Removed		100		ms

4. $T_A = 25^\circ\text{C}$

5. This parameter is guaranteed by design and characterization; not production tested.

6. $t_{DON}/t_{DOFF}/t_R/t_F$ are defined in figure below.

7. $t_{ON} = t_R + t_{DON}$.

8. $t_{OFF} = t_F + t_{DOFF}$.

9. After t_{READY} , the device is ready for maximum DC current load condition.

TIMING DIAGRAM

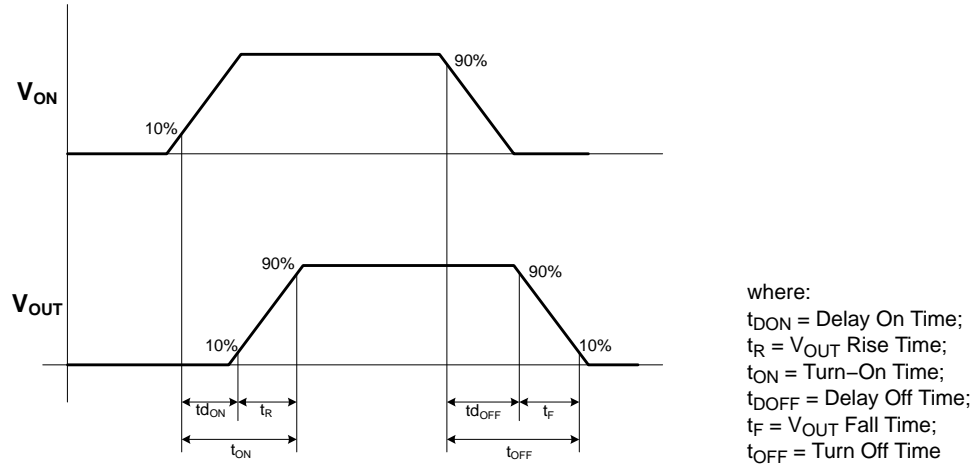

Figure 3. Timing Diagram

Device Fault Behavior Timing

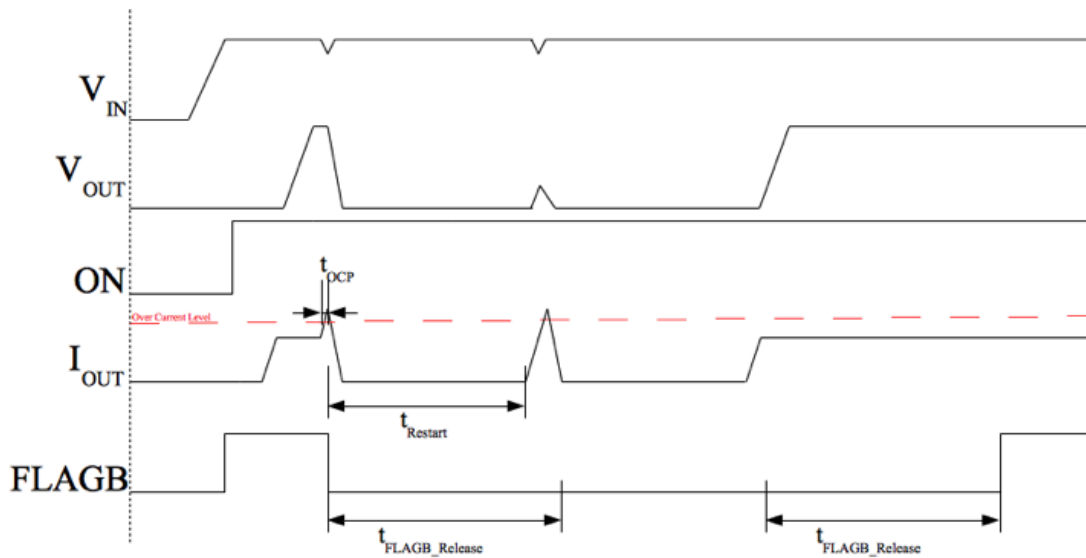

Figure 4. OCP Turn-Off Timing Diagram

OPERATION AND APPLICATION DESCRIPTION

Input Capacitor

To limit the voltage drop on the input supply caused by transient inrush current when the switch turns on into discharge load capacitor; a capacitor must be placed between the VIN and GND pins. A high-value CIN capacitor can be used to reduce the voltage drop in high-current applications.

Output Capacitor

An output capacitor should be placed between the VOUT and GND pins. This capacitor prevents parasitic board inductance from forcing VOUT below ground when the switch is on. This capacitor also prevents reverse inrush current from creating a voltage spike that could damage the device in the case of a VOUT short.

Fault Reporting

Upon the detection of an over-voltage, over-current, or over-temperature condition, the FLAGB signals the fault by activating LOW.

Under-Voltage Lockout (UVLO)

The under-voltage lockout turns the switch off if the input voltage drops below the lockout threshold. With the ON pin active, the input voltage rising above the UVLO threshold releases the lockout and enables the switch.

Over-Voltage Lockout (OVLO)

The OVLO pin sets the over-voltage lockout trip point with a resistor-divider network. OVLO adjustment is set by R1 and R2 and is compared to 1.2 V. When $V_{IN} \times R2 / (R1+R2) > 1.2$ V, which means $V_{IN} > V_{OVLO}$, the switch turns off to ensure protection to devices connected to

VOUT. A 1 MΩ or larger resistor is recommended on R1 to reduce standby power consumption. To use the default values of 5.8 V for VOVLO, connect the OVLO pin directly to GND.

Reverse-Current Blocking (RCB)

The reverse-current blocking feature protects the input source against current flow from output to input. When the load switch is OFF, no current flows from the output to input.

Thermal Shutdown (TSD)

Thermal shutdown protects the die from internally or externally generated excessive temperature. During an over-temperature condition, the switch is turned off. The switch automatically turns on again if the temperature of the die drops below the threshold temperature.

Current Limit

The current limit ensures that the current flow through the switch doesn't exceed a maximum value, which can damage the device. If the current flow through the switch exceeds the trip point, the switch turns off and enters the blanking time. After the blanking time, the switch is re-enabled and checks if the fault still exists.

Board Layout

For best performance, all traces should be as short as possible. The input and output capacitors should be placed close to the device to minimize the effect that parasitic trace inductance may have on normal and short-circuit operation. Using wide traces for VIN, VOUT, GND minimizes parasitic electrical effects along with minimizing the case-to-ambient thermal impedance.

Table 5. PACKAGE SPECIFIC DIMENSIONS

D	E	X	Y
1.300 ± 0.030	1.050 ± 0.030	0.325	0.250

ORDERING INFORMATION

Part Number	Operating Temperature	Package	Packing Method†
FPF2498BUCX	-40°C to 85°C	WLCSP6 (Pb-Free)	3000 / Tape & Reel

†For information on tape and reel specifications, including part orientation and tape sizes, please refer to our Tape and Reel Packaging Specifications Brochure, BRD8011/D



WLCSP6 1.30x1.05x0.586
CASE 567RT
ISSUE O

DATE 30 NOV 2016

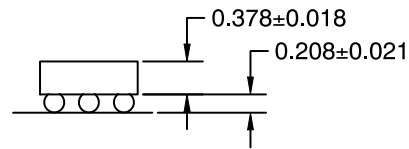
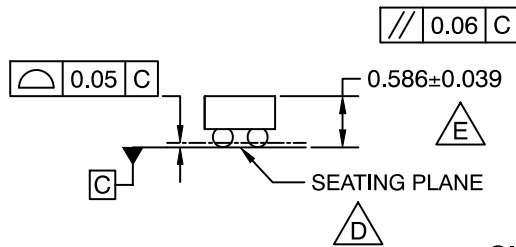
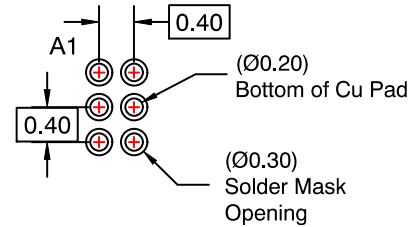
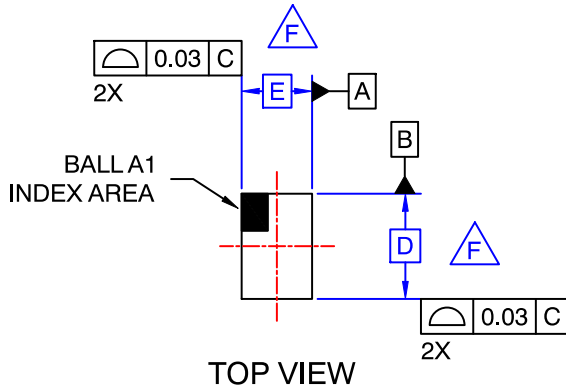

NOTES:

- A. NO JEDEC REGISTRATION APPLIES.
- B. DIMENSIONS ARE IN MILLIMETERS.
- C. DIMENSIONS AND TOLERANCES PER ASMEY14.5M, 2009.
- D. DATUM C, THE SEATING PLANE IS DEFINED BY THE SPHERICAL CROWNS OF THE BALLS.
- E. PACKAGE TYPICAL HEIGHT IS 586 MICRONS ±39 MICRONS (547–625 MICRONS).
- F. FOR DIMENSIONS D, E, X, AND Y, SEE PRODUCT DATASHEET.

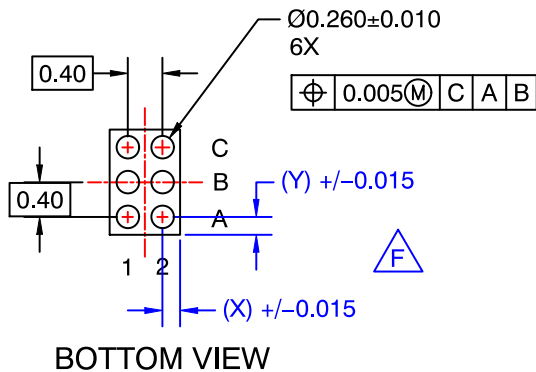

DOCUMENT NUMBER:	98AON16586G	Electronic versions are uncontrolled except when accessed directly from the Document Repository. Printed versions are uncontrolled except when stamped "CONTROLLED COPY" in red.
DESCRIPTION:	WLCSP6 1.30x1.05x0.586	PAGE 1 OF 1

ON Semiconductor and are trademarks of Semiconductor Components Industries, LLC dba ON Semiconductor or its subsidiaries in the United States and/or other countries. ON Semiconductor reserves the right to make changes without further notice to any products herein. ON Semiconductor makes no warranty, representation or guarantee regarding the suitability of its products for any particular purpose, nor does ON Semiconductor assume any liability arising out of the application or use of any product or circuit, and specifically disclaims any and all liability, including without limitation special, consequential or incidental damages. ON Semiconductor does not convey any license under its patent rights nor the rights of others.

onsemi, **Onsemi**, and other names, marks, and brands are registered and/or common law trademarks of Semiconductor Components Industries, LLC dba "**onsemi**" or its affiliates and/or subsidiaries in the United States and/or other countries. **onsemi** owns the rights to a number of patents, trademarks, copyrights, trade secrets, and other intellectual property. A listing of **onsemi**'s product/patent coverage may be accessed at www.onsemi.com/site/pdf/Patent-Marking.pdf. **onsemi** reserves the right to make changes at any time to any products or information herein, without notice. The information herein is provided "as-is" and **onsemi** makes no warranty, representation or guarantee regarding the accuracy of the information, product features, availability, functionality, or suitability of its products for any particular purpose, nor does **onsemi** assume any liability arising out of the application or use of any product or circuit, and specifically disclaims any and all liability, including without limitation special, consequential or incidental damages. Buyer is responsible for its products and applications using **onsemi** products, including compliance with all laws, regulations and safety requirements or standards, regardless of any support or applications information provided by **onsemi**. "Typical" parameters which may be provided in **onsemi** data sheets and/or specifications can and do vary in different applications and actual performance may vary over time. All operating parameters, including "Typicals" must be validated for each customer application by customer's technical experts. **onsemi** does not convey any license under any of its intellectual property rights nor the rights of others. **onsemi** products are not designed, intended, or authorized for use as a critical component in life support systems or any FDA Class 3 medical devices or medical devices with a same or similar classification in a foreign jurisdiction or any devices intended for implantation in the human body. Should Buyer purchase or use **onsemi** products for any such unintended or unauthorized application, Buyer shall indemnify and hold **onsemi** and its officers, employees, subsidiaries, affiliates, and distributors harmless against all claims, costs, damages, and expenses, and reasonable attorney fees arising out of, directly or indirectly, any claim of personal injury or death associated with such unintended or unauthorized use, even if such claim alleges that **onsemi** was negligent regarding the design or manufacture of the part. **onsemi** is an Equal Opportunity/Affirmative Action Employer. This literature is subject to all applicable copyright laws and is not for resale in any manner.

PUBLICATION ORDERING INFORMATION

LITERATURE FULFILLMENT:

Email Requests to: orderlit@onsemi.com

onsemi Website: www.onsemi.com

TECHNICAL SUPPORT

North American Technical Support:

Voice Mail: 1 800-282-9855 Toll Free USA/Canada

Phone: 011 421 33 790 2910

Europe, Middle East and Africa Technical Support:

Phone: 00421 33 790 2910

For additional information, please contact your local Sales Representative