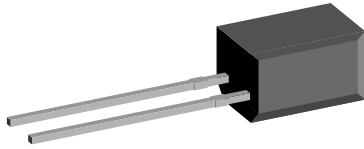


## Silicon PIN Photodiode



94 8480

### DESCRIPTION

BPW41N is a PIN photodiode with high speed and high radiant sensitivity in a black, side view plastic package with daylight blocking filter. Filter bandwidth is matched with 900 nm to 950 nm IR emitters.

### FEATURES

- Package type: leaded
- Package form: side view
- Dimensions (in mm): 5 x 4 x 6.8
- Radiant sensitive area (in mm<sup>2</sup>): 7.5
- High radiant sensitivity
- Daylight blocking filter matched with 940 nm emitters
- Fast response times
- Angle of half sensitivity:  $\phi = \pm 65^\circ$
- Compliant to RoHS Directive to 2002/95/EC and in accordance to WEEE 2002/96/EC



### Note

\*\* Please see document "Vishay Material Category Policy":  
[www.vishay.com/doc?99902](http://www.vishay.com/doc?99902)

### APPLICATIONS

- High speed detector for infrared radiation
- Infrared remote control and free air data transmission systems, e.g. in combination with TSALxxxx series IR emitters

PRODUCT SUMMARY			
COMPONENT	$I_{ra}$ ( $\mu A$ )	$\phi$ (deg)	$\lambda_{0.5}$ (nm)
BPW41N	45	$\pm 65$	870 to 1050

### Note

- Test condition see table "Basic Characteristics"

ORDERING INFORMATION			
ORDERING CODE	PACKAGING	REMARKS	PACKAGE FORM
BPW41N	Bulk	MOQ: 4000 pcs, 4000 pcs/bulk	Side view

### Note

- MOQ: minimum order quantity

ABSOLUTE MAXIMUM RATINGS ( $T_{amb} = 25^\circ C$ , unless otherwise specified)				
PARAMETER	TEST CONDITION	SYMBOL	VALUE	UNIT
Reverse voltage		$V_R$	60	V
Power dissipation	$T_{amb} \leq 25^\circ C$	$P_V$	215	mW
Junction temperature		$T_j$	100	$^\circ C$
Operating temperature range		$T_{amb}$	- 40 to + 100	$^\circ C$
Storage temperature range		$T_{stg}$	- 40 to + 100	$^\circ C$
Soldering temperature	$t \leq 5$ s	$T_{sd}$	260	$^\circ C$
Thermal resistance junction/ambient	Connected with Cu wire, 0.14 mm <sup>2</sup>	$R_{thJA}$	350	K/W

<b>BASIC CHARACTERISTICS</b> ( $T_{amb} = 25\text{ }^{\circ}\text{C}$ , unless otherwise specified)						
PARAMETER	TEST CONDITION	SYMBOL	MIN.	TYP.	MAX.	UNIT
Breakdown voltage	$I_R = 100\text{ }\mu\text{A}$ , $E = 0$	$V_{(BR)}$	60			V
Reverse dark current	$V_R = 10\text{ V}$ , $E = 0$	$I_{ro}$		2	30	nA
Diode capacitance	$V_R = 0\text{ V}$ , $f = 1\text{ MHz}$ , $E = 0$	$C_D$		70		pF
	$V_R = 3\text{ V}$ , $f = 1\text{ MHz}$ , $E = 0$	$C_D$		25	40	pF
Open circuit Voltage	$E_e = 1\text{ mW/cm}^2$ , $\lambda = 950\text{ nm}$	$V_o$		350		mV
Temperature coefficient of $V_o$	$E_e = 1\text{ mW/cm}^2$ , $\lambda = 950\text{ nm}$	$TK_{V_o}$		- 2.6		mV/K
Short circuit current	$E_e = 1\text{ mW/cm}^2$ , $\lambda = 950\text{ nm}$	$I_k$		38		$\mu\text{A}$
Temperature coefficient of $I_k$	$E_e = 1\text{ mW/cm}^2$ , $\lambda = 950\text{ nm}$	$TK_{I_k}$		0.1		%/K
Reverse light current	$E_e = 1\text{ mW/cm}^2$ , $\lambda = 950\text{ nm}$ , $V_R = 5\text{ V}$	$I_{ra}$	43	45		$\mu\text{A}$
Angle of half sensitivity		$\phi$		$\pm 65$		deg
Wavelength of peak sensitivity		$\lambda_p$		950		nm
Range of spectral bandwidth		$\lambda_{0.5}$		870 to 1050		nm
Noise equivalent power	$V_R = 10\text{ V}$ , $\lambda = 950\text{ nm}$	NEP		$4 \times 10^{-14}$		$\text{W}/\sqrt{\text{Hz}}$
Rise time	$V_R = 10\text{ V}$ , $R_L = 1\text{ k}\Omega$ , $\lambda = 820\text{ nm}$	$t_r$		100		ns
Fall time	$V_R = 10\text{ V}$ , $R_L = 1\text{ k}\Omega$ , $\lambda = 820\text{ nm}$	$t_f$		100		ns

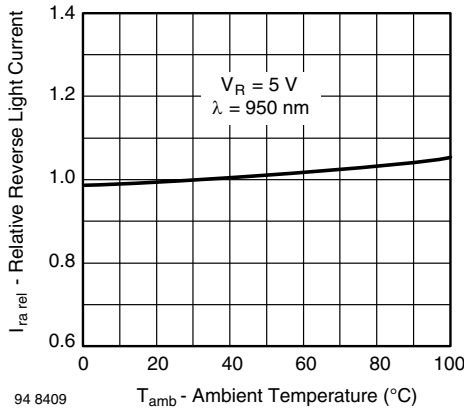
**BASIC CHARACTERISTICS** ( $T_{amb} = 25\text{ }^{\circ}\text{C}$ , unless otherwise specified)


Fig. 1 - Relative Reverse Light Current vs. Ambient Temperature

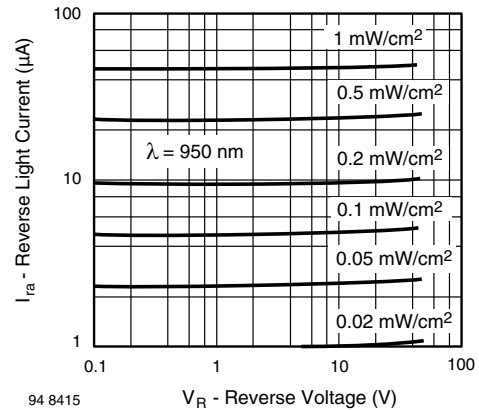


Fig. 3 - Reverse Light Current vs. Reverse Voltage

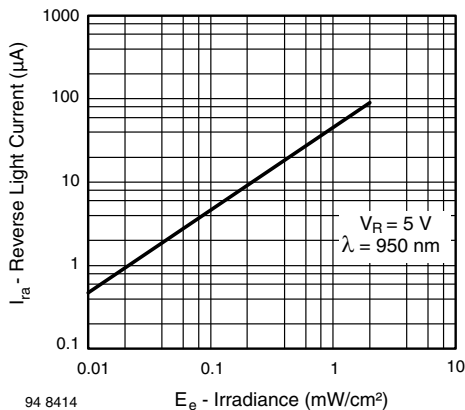


Fig. 2 - Reverse Light Current vs. Irradiance

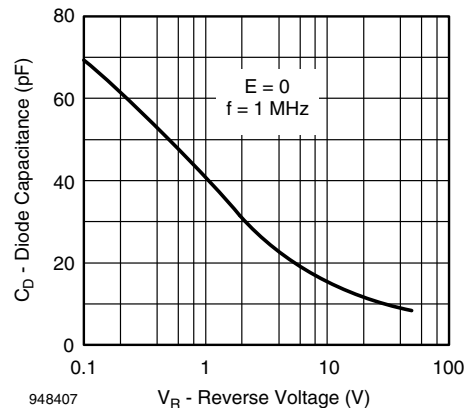


Fig. 4 - Diode Capacitance vs. Reverse Voltage

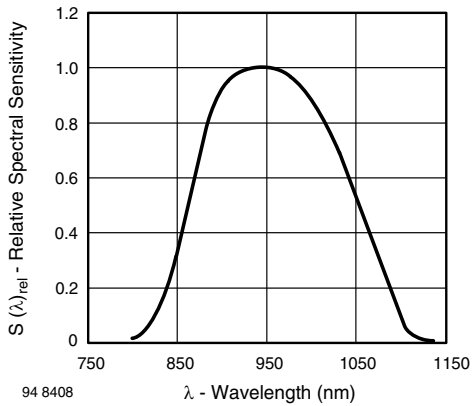


Fig. 5 - Relative Spectral Sensitivity vs. Wavelength

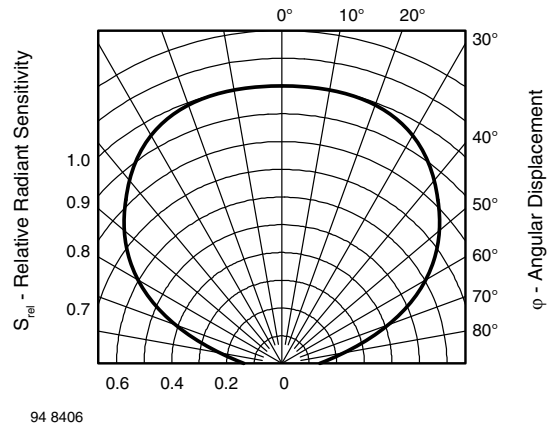
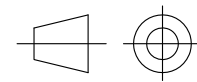
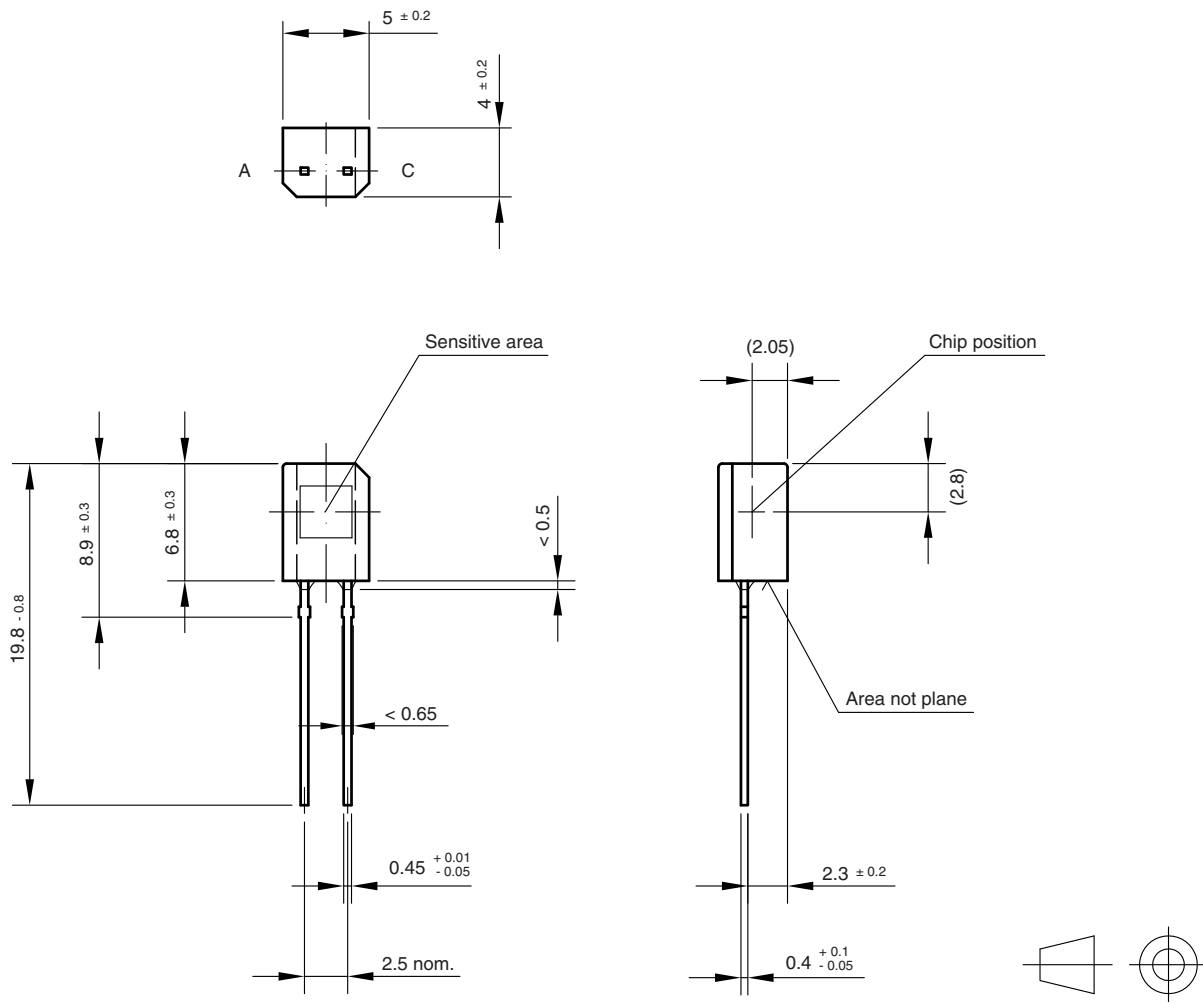


Fig. 6 - Relative Radiant Sensitivity vs. Angular Displacement

**PACKAGE DIMENSIONS** in millimeters



technical drawings  
according to DIN  
specifications

Drawing-No.: 6.544-5108.01-4  
Issue:1; 01.07.96  
96 12195



## **Disclaimer**

ALL PRODUCT, PRODUCT SPECIFICATIONS AND DATA ARE SUBJECT TO CHANGE WITHOUT NOTICE TO IMPROVE RELIABILITY, FUNCTION OR DESIGN OR OTHERWISE.

Vishay Intertechnology, Inc., its affiliates, agents, and employees, and all persons acting on its or their behalf (collectively, "Vishay"), disclaim any and all liability for any errors, inaccuracies or incompleteness contained in any datasheet or in any other disclosure relating to any product.

Vishay makes no warranty, representation or guarantee regarding the suitability of the products for any particular purpose or the continuing production of any product. To the maximum extent permitted by applicable law, Vishay disclaims (i) any and all liability arising out of the application or use of any product, (ii) any and all liability, including without limitation special, consequential or incidental damages, and (iii) any and all implied warranties, including warranties of fitness for particular purpose, non-infringement and merchantability.

Statements regarding the suitability of products for certain types of applications are based on Vishay's knowledge of typical requirements that are often placed on Vishay products in generic applications. Such statements are not binding statements about the suitability of products for a particular application. It is the customer's responsibility to validate that a particular product with the properties described in the product specification is suitable for use in a particular application. Parameters provided in datasheets and / or specifications may vary in different applications and performance may vary over time. All operating parameters, including typical parameters, must be validated for each customer application by the customer's technical experts. Product specifications do not expand or otherwise modify Vishay's terms and conditions of purchase, including but not limited to the warranty expressed therein.

Except as expressly indicated in writing, Vishay products are not designed for use in medical, life-saving, or life-sustaining applications or for any other application in which the failure of the Vishay product could result in personal injury or death. Customers using or selling Vishay products not expressly indicated for use in such applications do so at their own risk. Please contact authorized Vishay personnel to obtain written terms and conditions regarding products designed for such applications.

No license, express or implied, by estoppel or otherwise, to any intellectual property rights is granted by this document or by any conduct of Vishay. Product names and markings noted herein may be trademarks of their respective owners.