

# NL17SG04

## Single Inverter

The NL17SG04 MiniGate™ is an advanced high-speed CMOS Inverter in ultra-small footprint.

The NL17SG04 input structures provides protection when voltages up to 4.6 V are applied.

### Features

- Wide Operating  $V_{CC}$  Range: 0.9 V to 3.6 V
- High Speed:  $t_{PD} = 2.3$  ns (Typ) at  $V_{CC} = 3.0$  V,  $C_L = 15$  pF
- Low Power Dissipation:  $I_{CC} = 0.5$   $\mu$ A (Max) at  $T_A = 25^\circ$ C
- 4.6 V Overvoltage Tolerant (OVT) Input Pins
- Ultra-Small Packages
- These are Pb-Free and Halide-Free Devices

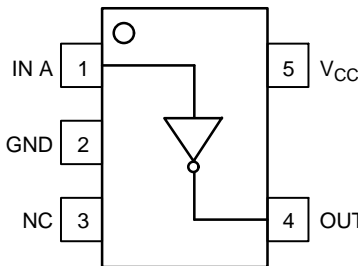

Figure 1. SOT-953 (Top Thru View)

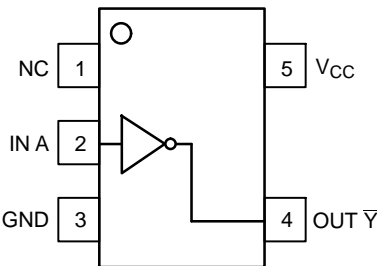

Figure 2. SC-88A (Top View)

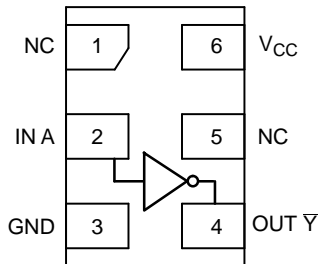

Figure 3. UDFN (Top View)

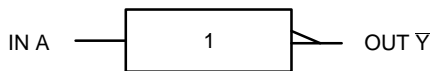

Figure 4. Logic Symbol



ON Semiconductor®

[www.onsemi.com](http://www.onsemi.com)

### MARKING DIAGRAMS



SOT-953  
CASE 527AE

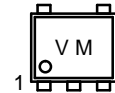

UDFN6  
1.0 x 1.0  
CASE 517BX



UDFN6  
1.45 x 1.0  
CASE 517AQ

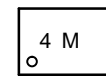

SC-88A  
DF SUFFIX  
CASE 419A

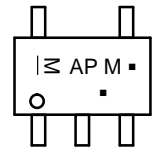

M = Date Code\*  
▪ = Pb-Free Package

(Note: Microdot may be in either location)

\*Date Code orientation and/or position may vary depending upon manufacturing location.

### PIN ASSIGNMENT

|   | SOT-953         | SC-88A          | UDFN6           |
|---|-----------------|-----------------|-----------------|
| 1 | IN A            | NC              | NC              |
| 2 | GND             | IN A            | IN A            |
| 3 | NC              | GND             | GND             |
| 4 | OUT Y-bar       | OUT Y-bar       | OUT Y-bar       |
| 5 | V <sub>CC</sub> | V <sub>CC</sub> | NC              |
| 6 |                 |                 | V <sub>CC</sub> |

### FUNCTION TABLE

| A Input | Y-bar Output |
|---------|--------------|
| L       | H            |
| H       | L            |

### ORDERING INFORMATION

See detailed ordering and shipping information on page 5 of this data sheet.

# NL17SG04

## MAXIMUM RATINGS

| Symbol        | Parameter                                                                                     | Value                                  | Unit               |
|---------------|-----------------------------------------------------------------------------------------------|----------------------------------------|--------------------|
| $V_{CC}$      | DC Supply Voltage                                                                             | -0.5 to +5.5                           | V                  |
| $V_{IN}$      | DC Input Voltage                                                                              | -0.5 to +4.6                           | V                  |
| $V_{OUT}$     | DC Output Voltage<br>Output at High or Low State<br>Power-Down Mode ( $V_{CC} = 0\text{ V}$ ) | -0.5 to $V_{CC} + 0.5$<br>-0.5 to +4.6 | V                  |
| $I_{IK}$      | DC Input Diode Current<br>$V_{IN} < \text{GND}$                                               | -20                                    | mA                 |
| $I_{OK}$      | DC Output Diode Current<br>$V_{OUT} < \text{GND}$                                             | -20                                    | mA                 |
| $I_{OUT}$     | DC Output Source/Sink Current                                                                 | $\pm 20$                               | mA                 |
| $I_{CC}$      | DC Supply Current per Supply Pin                                                              | $\pm 20$                               | mA                 |
| $I_{GND}$     | DC Ground Current per Ground Pin                                                              | $\pm 20$                               | mA                 |
| $T_{STG}$     | Storage Temperature Range                                                                     | -65 to +150                            | $^{\circ}\text{C}$ |
| $T_L$         | Lead Temperature, 1 mm from Case for 10 Seconds                                               | 260                                    | $^{\circ}\text{C}$ |
| $T_J$         | Junction Temperature Under Bias                                                               | +150                                   | $^{\circ}\text{C}$ |
| MSL           | Moisture Sensitivity                                                                          | Level 1                                |                    |
| $F_R$         | Flammability Rating<br>Oxygen Index: 28 to 34                                                 | UL 94 V-0 @ 0.125 in                   |                    |
| $V_{ESD}$     | ESD Withstand Voltage<br>Human Body Model (Note 2)<br>Machine Model (Note 3)                  | >2000<br>>100                          | V                  |
| $I_{LATCHUP}$ | Latchup Performance<br>Above $V_{CC}$ and Below GND at 125 $^{\circ}\text{C}$ (Note 4)        | $\pm 100$                              | mA                 |

Stresses exceeding those listed in the Maximum Ratings table may damage the device. If any of these limits are exceeded, device functionality should not be assumed, damage may occur and reliability may be affected.

1. Measured with minimum pad spacing on an FR4 board, using 10 mm-by-1 inch, 2-ounce copper trace with no air flow.
2. Tested to EIA/JESD22-A114-A.
3. Tested to EIA/JESD22-A115-A.
4. Tested to EIA/JESD78.

## RECOMMENDED OPERATING CONDITIONS

| Symbol                | Characteristics                                                                            | Min        | Max             | Unit               |
|-----------------------|--------------------------------------------------------------------------------------------|------------|-----------------|--------------------|
| $V_{CC}$              | Positive DC Supply Voltage                                                                 | 0.9        | 3.6             | V                  |
| $V_{IN}$              | Digital Input Voltage                                                                      | 0.0        | 3.6             | V                  |
| $V_{OUT}$             | Output Voltage<br>Output at High or Low State<br>Power-Down Mode ( $V_{CC} = 0\text{ V}$ ) | 0.0<br>0.0 | $V_{CC}$<br>3.6 | V                  |
| $T_A$                 | Operating Temperature Range                                                                | -55        | +125            | $^{\circ}\text{C}$ |
| $\Delta t / \Delta V$ | Input Transition Rise or Fall Rate<br>$V_{CC} = 3.3\text{ V} \pm 0.3\text{ V}$             | 0          | 10              | ns/V               |

Functional operation above the stresses listed in the Recommended Operating Ranges is not implied. Extended exposure to stresses beyond the Recommended Operating Ranges limits may affect device reliability.

# NL17SG04

## DC ELECTRICAL CHARACTERISTICS

| Symbol          | Parameter                 | Conditions                                           | V <sub>CC</sub> (V)       | T <sub>A</sub> = 25°C |                       | T <sub>A</sub> = -55°C to +125°C |                       | Unit |
|-----------------|---------------------------|------------------------------------------------------|---------------------------|-----------------------|-----------------------|----------------------------------|-----------------------|------|
|                 |                           |                                                      |                           | Min                   | Max                   | Min                              | Max                   |      |
| V <sub>IH</sub> | High-Level Input Voltage  |                                                      | 0.9                       | V <sub>CC</sub>       |                       | V <sub>CC</sub>                  |                       | V    |
|                 |                           |                                                      | 1.1 to 1.3                | 0.7xV <sub>CC</sub>   |                       | 0.7xV <sub>CC</sub>              |                       |      |
|                 |                           |                                                      | 1.4 to 1.6                | 0.65xV <sub>CC</sub>  |                       | 0.65xV <sub>CC</sub>             |                       |      |
|                 |                           |                                                      | 1.65 to 1.95              | 0.65xV <sub>CC</sub>  |                       | 0.65xV <sub>CC</sub>             |                       |      |
|                 |                           |                                                      | 2.3 to 2.7                | 1.7                   |                       | 1.7                              |                       |      |
|                 |                           |                                                      | 3.0 to 3.6                | 2.0                   |                       | 2.0                              |                       |      |
| V <sub>IL</sub> | Low-Level Input Voltage   |                                                      | 0.9                       |                       | GND                   |                                  | GND                   | V    |
|                 |                           |                                                      | 1.1 to 1.3                |                       | 0.3xV <sub>CC</sub>   |                                  | 0.3xV <sub>CC</sub>   |      |
|                 |                           |                                                      | 1.4 to 1.6                |                       | 0.35xV <sub>CC</sub>  |                                  | 0.35xV <sub>CC</sub>  |      |
|                 |                           |                                                      | 1.65 to 1.95              |                       | 0.35xV <sub>CC</sub>  |                                  | 0.35xV <sub>CC</sub>  |      |
|                 |                           |                                                      | 2.3 to 2.7                |                       | 0.7                   |                                  | 0.7                   |      |
|                 |                           |                                                      | 3.0 to 3.6                |                       | 0.8                   |                                  | 0.8                   |      |
| V <sub>OH</sub> | High-Level Output Voltage | V <sub>IN</sub> = V <sub>IH</sub> or V <sub>IL</sub> | I <sub>OH</sub> = -20 μA  | 0.9                   | 0.75                  |                                  | 0.75                  | V    |
|                 |                           |                                                      | I <sub>OH</sub> = -0.3 mA | 1.1 to 1.3            | 0.75xV <sub>CC</sub>  |                                  | 0.75xV <sub>CC</sub>  |      |
|                 |                           |                                                      | I <sub>OH</sub> = -1.7 mA | 1.4 to 1.6            | 0.75xV <sub>CC</sub>  |                                  | 0.75xV <sub>CC</sub>  |      |
|                 |                           |                                                      | I <sub>OH</sub> = -3.0 mA | 1.65 to 1.95          | V <sub>CC</sub> -0.45 |                                  | V <sub>CC</sub> -0.45 |      |
|                 |                           |                                                      | I <sub>OH</sub> = -4.0 mA | 2.3 to 2.7            | 2.0                   |                                  | 2.0                   |      |
|                 |                           |                                                      | I <sub>OH</sub> = -8.0 mA | 3.0 to 3.6            | 2.48                  |                                  | 2.48                  |      |
| V <sub>OL</sub> | Low-Level Output Voltage  | V <sub>IN</sub> = V <sub>IH</sub> or V <sub>IL</sub> | I <sub>OL</sub> = 20 μA   | 0.9                   |                       | 0.1                              | 0.1                   | V    |
|                 |                           |                                                      | I <sub>OL</sub> = 0.3 mA  | 1.1 to 1.3            |                       | 0.25xV <sub>CC</sub>             | 0.25xV <sub>CC</sub>  |      |
|                 |                           |                                                      | I <sub>OL</sub> = 1.7 mA  | 1.4 to 1.6            |                       | 0.25xV <sub>CC</sub>             | 0.25xV <sub>CC</sub>  |      |
|                 |                           |                                                      | I <sub>OL</sub> = 3.0 mA  | 1.65 to 1.95          |                       | 0.45                             | 0.45                  |      |
|                 |                           |                                                      | I <sub>OL</sub> = 4.0 mA  | 2.3 to 2.7            |                       | 0.4                              | 0.4                   |      |
|                 |                           |                                                      | I <sub>OL</sub> = 8.0 mA  | 3.0 to 3.6            |                       | 0.4                              | 0.4                   |      |
| I <sub>IN</sub> | Input Leakage Current     | 0 ≤ V <sub>IN</sub> ≤ 3.6 V                          | 0 to 3.6                  |                       | ±0.1                  |                                  | ±1.0                  | μA   |
| I <sub>CC</sub> | Quiescent Supply Current  | V <sub>IN</sub> = V <sub>CC</sub> or GND             | 3.6                       |                       | 0.5                   |                                  | 10.0                  | μA   |

Product parametric performance is indicated in the Electrical Characteristics for the listed test conditions, unless otherwise noted. Product performance may not be indicated by the Electrical Characteristics if operated under different conditions.

# NL17SG04

## AC ELECTRICAL CHARACTERISTICS Input $t_r = t_f = 3.0$ ns

| Symbol                   | Parameter                              | Test Condition                         | $V_{CC}$ (V) | $T_A = 25^\circ\text{C}$ |       |      | $T_A = -55^\circ\text{C to } +125^\circ\text{C}$ |      | Unit |
|--------------------------|----------------------------------------|----------------------------------------|--------------|--------------------------|-------|------|--------------------------------------------------|------|------|
|                          |                                        |                                        |              | Min                      | Typ   | Max  | Min                                              | Max  |      |
| $t_{PLH}$ ,<br>$t_{PHL}$ | Propagation Delay,<br>A to Y           | $C_L = 10$ pF,<br>$R_L = 1$ M $\Omega$ | 0.9          | -                        | 10.0  | 13.3 | -                                                | 17.0 | ns   |
|                          |                                        |                                        | 1.1 to 1.3   | -                        | 8.7   | 11.2 | -                                                | 14.0 |      |
|                          |                                        |                                        | 1.4 to 1.6   | -                        | 4.9   | 8.5  | -                                                | 10.0 |      |
|                          |                                        |                                        | 1.65 to 1.95 | -                        | 3.8   | 6.2  | -                                                | 6.7  |      |
|                          |                                        |                                        | 2.3 to 2.7   | -                        | 2.6   | 3.9  | -                                                | 4.4  |      |
|                          |                                        |                                        | 3.0 to 3.6   | -                        | 2.1   | 3.1  | -                                                | 3.7  |      |
|                          |                                        | $C_L = 15$ pF,<br>$R_L = 1$ M $\Omega$ | 0.9          | -                        | 11.55 | 13.7 | -                                                | 19.7 | ns   |
|                          |                                        |                                        | 1.1 to 1.3   | -                        | 7.2   | 10.8 | -                                                | 15.6 |      |
|                          |                                        |                                        | 1.4 to 1.6   | -                        | 5.4   | 9.3  | -                                                | 11.2 |      |
|                          |                                        |                                        | 1.65 to 1.95 | -                        | 4.2   | 6.9  | -                                                | 7.1  |      |
|                          |                                        |                                        | 2.3 to 2.7   | -                        | 2.8   | 4.4  | -                                                | 5.0  |      |
|                          |                                        |                                        | 3.0 to 3.6   | -                        | 2.3   | 3.4  | -                                                | 3.9  |      |
|                          |                                        | $C_L = 30$ pF,<br>$R_L = 1$ M $\Omega$ | 0.9          | -                        | 16.85 | 18.9 | -                                                | 22.3 | ns   |
|                          |                                        |                                        | 1.1 to 1.3   | -                        | 10.2  | 13.4 | -                                                | 17.5 |      |
|                          |                                        |                                        | 1.4 to 1.6   | -                        | 7.4   | 13.1 | -                                                | 15.9 |      |
|                          |                                        |                                        | 1.65 to 1.95 | -                        | 5.6   | 9.2  | -                                                | 9.6  |      |
|                          |                                        |                                        | 2.3 to 2.7   | -                        | 3.7   | 5.7  | -                                                | 6.1  |      |
|                          |                                        |                                        | 3.0 to 3.6   | -                        | 2.9   | 4.4  | -                                                | 4.8  |      |
| $C_{IN}$                 | Input Capacitance                      |                                        | 0 to 3.6     |                          | 3     | -    | -                                                | pF   |      |
| $C_{PD}$                 | Power Dissipation Capacitance (Note 5) | $f = 10$ MHz                           | 0.9 to 3.6   | -                        | 4     | -    | -                                                | pF   |      |

Product parametric performance is indicated in the Electrical Characteristics for the listed test conditions, unless otherwise noted. Product performance may not be indicated by the Electrical Characteristics if operated under different conditions.

5.  $C_{PD}$  is defined as the value of the internal equivalent capacitance which is calculated from the operating current consumption without load. Average operating current can be obtained by the equation:  $I_{CC(OPR)} = C_{PD} \cdot V_{CC} \cdot f_{in} + I_{CC}$ .  $C_{PD}$  is used to determine the no-load dynamic power consumption;  $P_D = C_{PD} \cdot V_{CC}^2 \cdot f_{in} + I_{CC} \cdot V_{CC}$ .

# NL17SG04

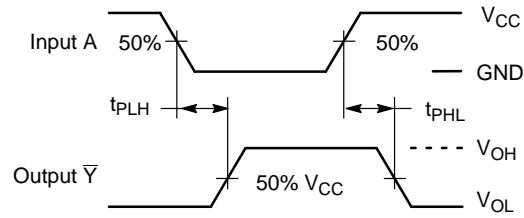

**Figure 5. Switching Waveforms**

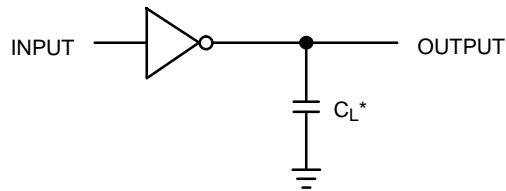

\*Includes all probe and jig capacitance.  
A 1-MHz square input wave is recommended for propagation delay tests.

**Figure 6. Test Circuit**

## ORDERING INFORMATION

| Device         | Package                      | Shipping†          |
|----------------|------------------------------|--------------------|
| NL17SG04P5T5G  | SOT-953<br>(Pb-Free)         | 8000 / Tape & Reel |
| NL17SG04DFT2G  | SC-88A<br>(Pb-Free)          | 3000 / Tape & Reel |
| NL17SG04AMUTCG | UDFN6 1.45x1 mm<br>(Pb-Free) | 3000 / Tape & Reel |
| NL17SG04CMUTCG | UDFN6 1x1 mm<br>(Pb-Free)    | 3000 / Tape & Reel |

†For information on tape and reel specifications, including part orientation and tape sizes, please refer to our Tape and Reel Packaging Specifications Brochure, BRD8011/D.

# MECHANICAL CASE OUTLINE

## PACKAGE DIMENSIONS

ON Semiconductor®



SCALE 2:1

SC-88A (SC-70-5/SOT-353)  
CASE 419A-02  
ISSUE L

DATE 17 JAN 2013



### SOLDER FOOTPRINT



NOTES:

1. DIMENSIONING AND TOLERANCING PER ANSI Y14.5M, 1982.
2. CONTROLLING DIMENSION: INCH.
3. 419A-01 OBSOLETE. NEW STANDARD 419A-02.
4. DIMENSIONS A AND B DO NOT INCLUDE MOLD FLASH, PROTRUSIONS, OR GATE BURRS.

| DIM | INCHES    |       | MILLIMETERS |      |
|-----|-----------|-------|-------------|------|
|     | MIN       | MAX   | MIN         | MAX  |
| A   | 0.071     | 0.087 | 1.80        | 2.20 |
| B   | 0.045     | 0.053 | 1.15        | 1.35 |
| C   | 0.031     | 0.043 | 0.80        | 1.10 |
| D   | 0.004     | 0.012 | 0.10        | 0.30 |
| G   | 0.026 BSC |       | 0.65 BSC    |      |
| H   | ---       | 0.004 | ---         | 0.10 |
| J   | 0.004     | 0.010 | 0.10        | 0.25 |
| K   | 0.004     | 0.012 | 0.10        | 0.30 |
| N   | 0.008 REF |       | 0.20 REF    |      |
| S   | 0.079     | 0.087 | 2.00        | 2.20 |

### GENERIC MARKING DIAGRAM\*

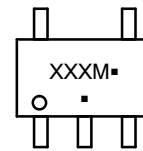

- XXX = Specific Device Code
- M = Date Code
- = Pb-Free Package

(Note: Microdot may be in either location)

\*This information is generic. Please refer to device data sheet for actual part marking. Pb-Free indicator, "G" or microdot "■", may or may not be present. Some products may not follow the Generic Marking.

- |                                                                                                                |                                                                                              |                                                                                                |                                                                                                  |                                                                                                                                                                    |
|----------------------------------------------------------------------------------------------------------------|----------------------------------------------------------------------------------------------|------------------------------------------------------------------------------------------------|--------------------------------------------------------------------------------------------------|--------------------------------------------------------------------------------------------------------------------------------------------------------------------|
| <p>STYLE 1:<br/>PIN 1. BASE<br/>2. EMITTER<br/>3. BASE<br/>4. COLLECTOR<br/>5. COLLECTOR</p>                   | <p>STYLE 2:<br/>PIN 1. ANODE<br/>2. EMITTER<br/>3. BASE<br/>4. COLLECTOR<br/>5. CATHODE</p>  | <p>STYLE 3:<br/>PIN 1. ANODE 1<br/>2. N/C<br/>3. ANODE 2<br/>4. CATHODE 2<br/>5. CATHODE 1</p> | <p>STYLE 4:<br/>PIN 1. SOURCE 1<br/>2. DRAIN 1/2<br/>3. SOURCE 1<br/>4. GATE 1<br/>5. GATE 2</p> | <p>STYLE 5:<br/>PIN 1. CATHODE<br/>2. COMMON ANODE<br/>3. CATHODE 2<br/>4. CATHODE 3<br/>5. CATHODE 4</p>                                                          |
| <p>STYLE 6:<br/>PIN 1. EMITTER 2<br/>2. BASE 2<br/>3. EMITTER 1<br/>4. COLLECTOR<br/>5. COLLECTOR 2/BASE 1</p> | <p>STYLE 7:<br/>PIN 1. BASE<br/>2. EMITTER<br/>3. BASE<br/>4. COLLECTOR<br/>5. COLLECTOR</p> | <p>STYLE 8:<br/>PIN 1. CATHODE<br/>2. COLLECTOR<br/>3. N/C<br/>4. BASE<br/>5. EMITTER</p>      | <p>STYLE 9:<br/>PIN 1. ANODE<br/>2. CATHODE<br/>3. ANODE<br/>4. ANODE<br/>5. ANODE</p>           | <p>Note: Please refer to datasheet for style callout. If style type is not called out in the datasheet refer to the device datasheet pinout or pin assignment.</p> |

|                  |                          |                                                                                                                                                                                  |
|------------------|--------------------------|----------------------------------------------------------------------------------------------------------------------------------------------------------------------------------|
| DOCUMENT NUMBER: | 98ASB42984B              | Electronic versions are uncontrolled except when accessed directly from the Document Repository. Printed versions are uncontrolled except when stamped "CONTROLLED COPY" in red. |
| DESCRIPTION:     | SC-88A (SC-70-5/SOT-353) | PAGE 1 OF 1                                                                                                                                                                      |

ON Semiconductor and ON are trademarks of Semiconductor Components Industries, LLC dba ON Semiconductor or its subsidiaries in the United States and/or other countries. ON Semiconductor reserves the right to make changes without further notice to any products herein. ON Semiconductor makes no warranty, representation or guarantee regarding the suitability of its products for any particular purpose, nor does ON Semiconductor assume any liability arising out of the application or use of any product or circuit, and specifically disclaims any and all liability, including without limitation special, consequential or incidental damages. ON Semiconductor does not convey any license under its patent rights nor the rights of others.

# MECHANICAL CASE OUTLINE

## PACKAGE DIMENSIONS

ON Semiconductor®

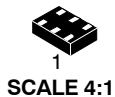

UDFN6, 1.45x1.0, 0.5P  
CASE 517AQ-01  
ISSUE O

DATE 15 MAY 2008

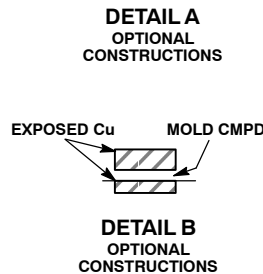
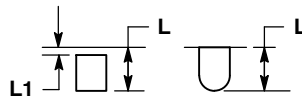
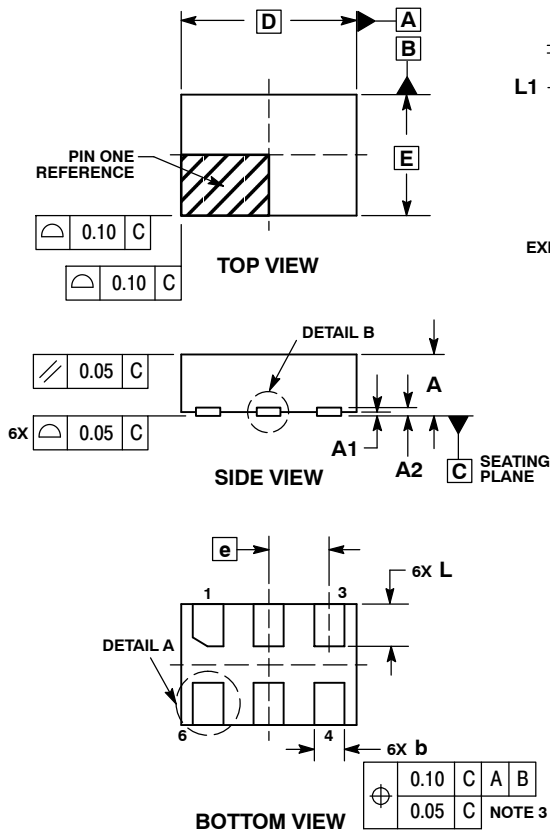

- NOTES:
1. DIMENSIONING AND TOLERANCING PER ASME Y14.5M, 1994.
  2. CONTROLLING DIMENSION: MILLIMETERS.
  3. DIMENSION b APPLIES TO PLATED TERMINAL AND IS MEASURED BETWEEN 0.15 AND 0.30 mm FROM THE TERMINAL TIP.

| MILLIMETERS |      |      |
|-------------|------|------|
| DIM         | MIN  | MAX  |
| A           | 0.45 | 0.55 |
| A1          | 0.00 | 0.05 |
| A2          | 0.07 | REF  |
| b           | 0.20 | 0.30 |
| D           | 1.45 | BSC  |
| E           | 1.00 | BSC  |
| e           | 0.50 | BSC  |
| L           | 0.30 | 0.40 |
| L1          | ---  | 0.15 |

### GENERIC MARKING DIAGRAM\*



- X = Specific Device Code
- M = Date Code

\*This information is generic. Please refer to device data sheet for actual part marking. Pb-Free indicator, "G" or microdot "•", may or may not be present.

### MOUNTING FOOTPRINT

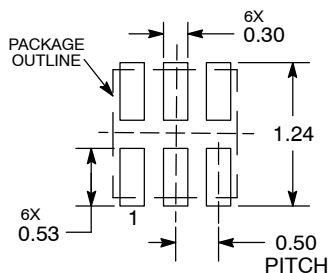

DIMENSIONS: MILLIMETERS

\*For additional information on our Pb-Free strategy and soldering details, please download the ON Semiconductor Soldering and Mounting Techniques Reference Manual, SOLDERRM/D.

|                         |                           |                                                                                                                                                                                  |
|-------------------------|---------------------------|----------------------------------------------------------------------------------------------------------------------------------------------------------------------------------|
| <b>DOCUMENT NUMBER:</b> | 98AON30313E               | Electronic versions are uncontrolled except when accessed directly from the Document Repository. Printed versions are uncontrolled except when stamped "CONTROLLED COPY" in red. |
| <b>STATUS:</b>          | ON SEMICONDUCTOR STANDARD |                                                                                                                                                                                  |
| <b>NEW STANDARD:</b>    |                           |                                                                                                                                                                                  |
| <b>DESCRIPTION:</b>     | UDFN6, 1.45X1.0, 0.5P     | <b>PAGE 1 OF 2</b>                                                                                                                                                               |









# MECHANICAL CASE OUTLINE

## PACKAGE DIMENSIONS

ON Semiconductor®



SCALE 4:1

**SOT-953**  
CASE 527AE  
ISSUE E

DATE 02 AUG 2011

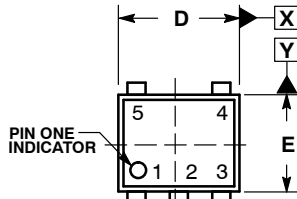

TOP VIEW

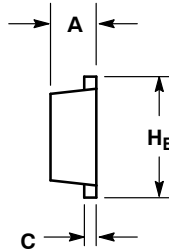

SIDE VIEW

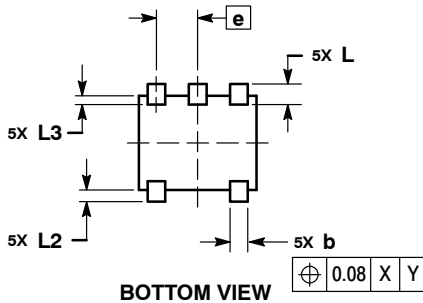

BOTTOM VIEW

**NOTES:**

1. DIMENSIONING AND TOLERANCING PER ASME Y14.5M, 1994.
2. CONTROLLING DIMENSION: MILLIMETERS
3. MAXIMUM LEAD THICKNESS INCLUDES LEAD FINISH. MINIMUM LEAD THICKNESS IS THE MINIMUM THICKNESS OF THE BASE MATERIAL.
4. DIMENSIONS D AND E DO NOT INCLUDE MOLD FLASH, PROTRUSIONS, OR GATE BURRS.

| DIM            | MILLIMETERS |      |      |
|----------------|-------------|------|------|
|                | MIN         | NOM  | MAX  |
| A              | 0.34        | 0.37 | 0.40 |
| b              | 0.10        | 0.15 | 0.20 |
| C              | 0.07        | 0.12 | 0.17 |
| D              | 0.95        | 1.00 | 1.05 |
| E              | 0.75        | 0.80 | 0.85 |
| e              | 0.35 BSC    |      |      |
| H <sub>E</sub> | 0.95        | 1.00 | 1.05 |
| L              | 0.175 REF   |      |      |
| L2             | 0.05        | 0.10 | 0.15 |
| L3             | ---         | ---  | 0.15 |

**GENERIC MARKING DIAGRAM\***

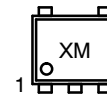

X = Specific Device Code  
M = Month Code

\*This information is generic. Please refer to device data sheet for actual part marking.  
Pb-Free indicator, "G" or microdot "▪", may or may not be present.

**SOLDERING FOOTPRINT\***

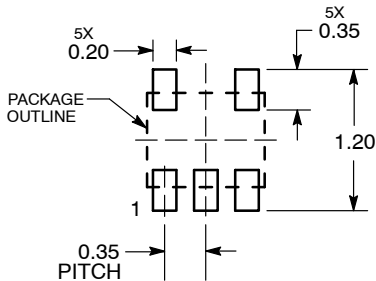

DIMENSIONS: MILLIMETERS

\*For additional information on our Pb-Free strategy and soldering details, please download the ON Semiconductor Soldering and Mounting Techniques Reference Manual, SOLDERRM/D.

|                         |                    |                                                                                                                                                                                  |
|-------------------------|--------------------|----------------------------------------------------------------------------------------------------------------------------------------------------------------------------------|
| <b>DOCUMENT NUMBER:</b> | <b>98AON26457D</b> | Electronic versions are uncontrolled except when accessed directly from the Document Repository. Printed versions are uncontrolled except when stamped "CONTROLLED COPY" in red. |
| <b>DESCRIPTION:</b>     | <b>SOT-953</b>     | <b>PAGE 1 OF 1</b>                                                                                                                                                               |

ON Semiconductor and are trademarks of Semiconductor Components Industries, LLC dba ON Semiconductor or its subsidiaries in the United States and/or other countries. ON Semiconductor reserves the right to make changes without further notice to any products herein. ON Semiconductor makes no warranty, representation or guarantee regarding the suitability of its products for any particular purpose, nor does ON Semiconductor assume any liability arising out of the application or use of any product or circuit, and specifically disclaims any and all liability, including without limitation special, consequential or incidental damages. ON Semiconductor does not convey any license under its patent rights nor the rights of others.

ON Semiconductor and  are trademarks of Semiconductor Components Industries, LLC dba ON Semiconductor or its subsidiaries in the United States and/or other countries. ON Semiconductor owns the rights to a number of patents, trademarks, copyrights, trade secrets, and other intellectual property. A listing of ON Semiconductor's product/patent coverage may be accessed at [www.onsemi.com/site/pdf/Patent-Marking.pdf](http://www.onsemi.com/site/pdf/Patent-Marking.pdf). ON Semiconductor reserves the right to make changes without further notice to any products herein. ON Semiconductor makes no warranty, representation or guarantee regarding the suitability of its products for any particular purpose, nor does ON Semiconductor assume any liability arising out of the application or use of any product or circuit, and specifically disclaims any and all liability, including without limitation special, consequential or incidental damages. Buyer is responsible for its products and applications using ON Semiconductor products, including compliance with all laws, regulations and safety requirements or standards, regardless of any support or applications information provided by ON Semiconductor. "Typical" parameters which may be provided in ON Semiconductor data sheets and/or specifications can and do vary in different applications and actual performance may vary over time. All operating parameters, including "Typicals" must be validated for each customer application by customer's technical experts. ON Semiconductor does not convey any license under its patent rights nor the rights of others. ON Semiconductor products are not designed, intended, or authorized for use as a critical component in life support systems or any FDA Class 3 medical devices or medical devices with a same or similar classification in a foreign jurisdiction or any devices intended for implantation in the human body. Should Buyer purchase or use ON Semiconductor products for any such unintended or unauthorized application, Buyer shall indemnify and hold ON Semiconductor and its officers, employees, subsidiaries, affiliates, and distributors harmless against all claims, costs, damages, and expenses, and reasonable attorney fees arising out of, directly or indirectly, any claim of personal injury or death associated with such unintended or unauthorized use, even if such claim alleges that ON Semiconductor was negligent regarding the design or manufacture of the part. ON Semiconductor is an Equal Opportunity/Affirmative Action Employer. This literature is subject to all applicable copyright laws and is not for resale in any manner.

## PUBLICATION ORDERING INFORMATION

### LITERATURE FULFILLMENT:

Email Requests to: [orderlit@onsemi.com](mailto:orderlit@onsemi.com)

ON Semiconductor Website: [www.onsemi.com](http://www.onsemi.com)

### TECHNICAL SUPPORT

North American Technical Support:  
Voice Mail: 1 800-282-9855 Toll Free USA/Canada  
Phone: 011 421 33 790 2910

### Europe, Middle East and Africa Technical Support:

Phone: 00421 33 790 2910

For additional information, please contact your local Sales Representative