



SB01-05Q

Schottky Barrier Diode 50V, 0.1A, Low IR, Single MCP

ON Semiconductor®

<http://onsemi.com>

Applications

- High frequency rectification (switching regulators, converters, choppers)

Features

- Low forward voltage (V_F max=0.55V)
- Low switching noise
- Low leakage current and high reliability due to highly reliable planar structure
- Small-sized package, permitting SB01-05Q-applied sets to be compact and slim
- Fast reverse recovery time (t_{rr} max=10ns)

Specifications

Absolute Maximum Ratings at $T_a=25^\circ\text{C}$

Parameter	Symbol	Conditions	Ratings	Unit
Repetitive Peak Reverse Voltage	V_{RRM}		50	V
Nonrepetitive Peak Reverse Surge Voltage	V_{RSM}		55	V
Average Output Current	I_O		100	mA
Surge Forward Current	I_{FSM}	50Hz sine wave, 1 cycle	2	A
Junction Temperature	T_j		-55 to +125	$^\circ\text{C}$
Storage Temperature	T_{stg}		-55 to +125	$^\circ\text{C}$

Stresses exceeding Maximum Ratings may damage the device. Maximum Ratings are stress ratings only. Functional operation above the Recommended Operating Conditions is not implied. Extended exposure to stresses above the Recommended Operating Conditions may affect device reliability.

Package Dimensions

unit : mm (typ)

7023A-005

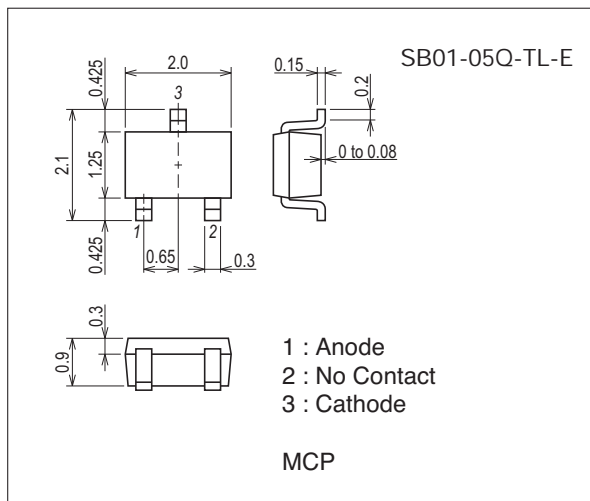

Product & Package Information

- Package : MCP
- JEITA, JEDEC : SC-70, SOT-323
- Minimum Packing Quantity : 3,000 pcs./reel

Packing Type: TL

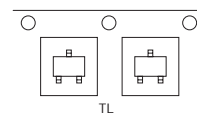

Marking

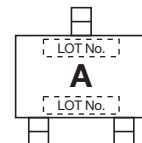

Electrical Connection

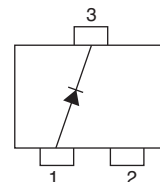

SB01-05Q

Electrical Characteristics at $T_a=25^\circ\text{C}$

Parameter	Symbol	Conditions	Ratings			Unit
			min	typ	max	
Reverse Voltage	V_R	$I_R=50\mu\text{A}$	50			V
Forward Voltage	V_F	$I_F=100\text{mA}$			0.55	V
Reverse Current	I_R	$V_R=25\text{V}$			15	μA
Interterminal Capacitance	C	$V_R=10\text{V}, f=1\text{MHz}$		4.4		pF
Reverse Recovery Time	t_{rr}	$I_F=I_R=10\text{mA}$, See specified Test Circuit.			10	ns

t_{rr} Test Circuit

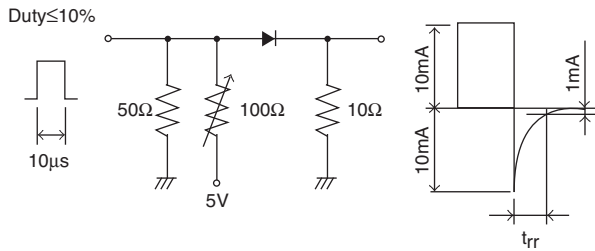

Ordering Information

Device	Package	Shipping	memo
SB01-05Q-TL-E	MCP	3,000pcs./reel	Pb Free

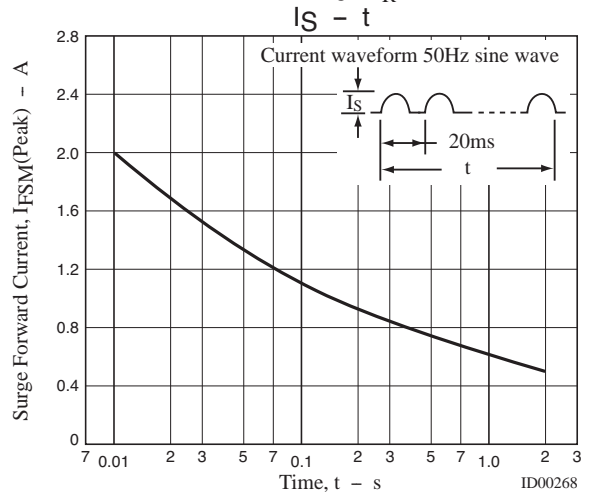
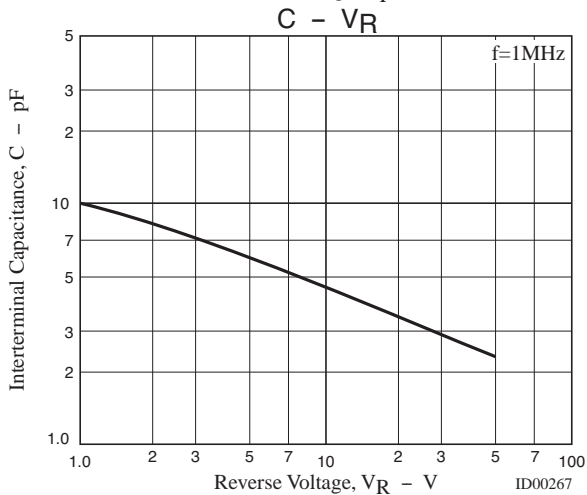
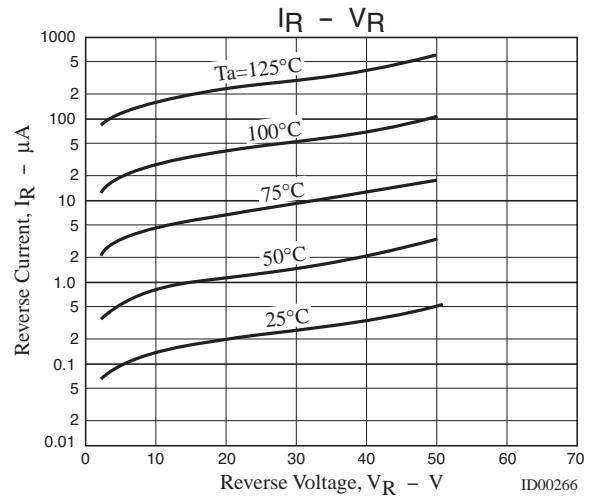
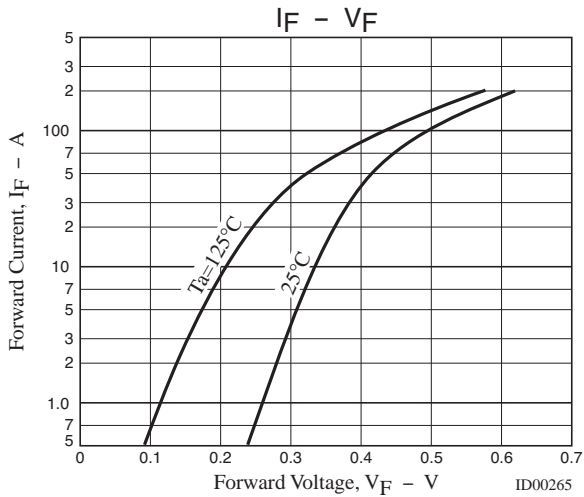

SB01-05Q

Outline Drawing

SB01-05Q-TL-E

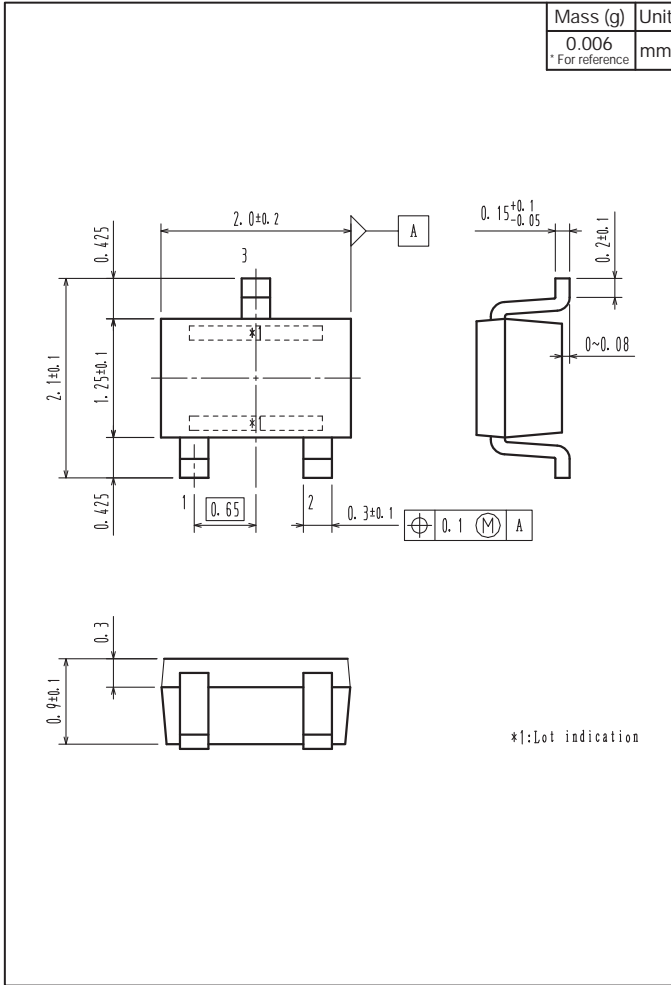

Land Pattern Example

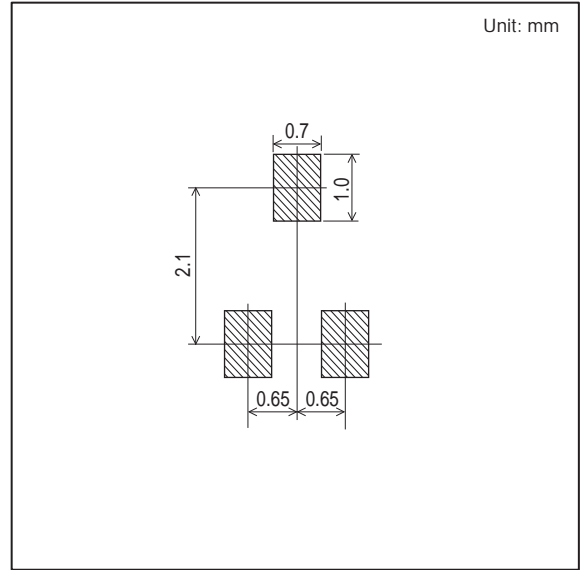

ON Semiconductor and the ON logo are registered trademarks of Semiconductor Components Industries, LLC (SCILLC). SCILLC owns the rights to a number of patents, trademarks, copyrights, trade secrets, and other intellectual property. A listing of SCILLC's product/patent coverage may be accessed at www.onsemi.com/site/pdf/Patent-Marking.pdf. SCILLC reserves the right to make changes without further notice to any products herein. SCILLC makes no warranty, representation or guarantee regarding the suitability of its products for any particular purpose, nor does SCILLC assume any liability arising out of the application or use of any product or circuit, and specifically disclaims any and all liability, including without limitation special, consequential or incidental damages. "Typical" parameters which may be provided in SCILLC data sheets and/or specifications can and do vary in different applications and actual performance may vary over time. All operating parameters, including "Typicals" must be validated for each customer application by customer's technical experts. SCILLC does not convey any license under its patent rights nor the rights of others. SCILLC products are not designed, intended, or authorized for use as components in systems intended for surgical implant into the body, or other applications intended to support or sustain life, or for any other application in which the failure of the SCILLC product could create a situation where personal injury or death may occur. Should Buyer purchase or use SCILLC products for any such unintended or unauthorized application, Buyer shall indemnify and hold SCILLC and its officers, employees, subsidiaries, affiliates, and distributors harmless against all claims, costs, damages, and expenses, and reasonable attorney fees arising out of, directly or indirectly, any claim of personal injury or death associated with such unintended or unauthorized use, even if such claim alleges that SCILLC was negligent regarding the design or manufacture of the part. SCILLC is an Equal Opportunity/Affirmative Action Employer. This literature is subject to all applicable copyright laws and is not for resale in any manner.