

Discontinuation Notice of Switch Mode Power Supply

S82K series

Product Discontinuation

Recommended Replacement



Switch Mode Power Supply
S82K series



S8VS series
(S8JX-G01515CD for 15V output models)

Discontinuation date : The end of September, 2010

Caution on recommended replacement

Dimensions and are different.
The positions of Input terminals and Output terminals are different.
There is a type with large Inrush current.
There is a type with long Startup time.
There is a type different in Overload protection characteristics.
Parallel operation can't be used.
There is no Undervoltage alarm indication for 15V output model (S8JX-G01515CD).
Undervoltage alarm output is changed to transistor output from relay output.

Difference from discontinued product

Model	Body Color	Dimensions	Wire connection	Mounting Dimensions	Characteristics	Operation ratings	Operation methods
S8VS series	*	--	--	**	*	*	*
	(depend on type)						
S8JX-G01515CD	--	--	--	**	*	*	*

** : Fully compatible

* : The change is a little / Almost compatible

-- : Not compatible

- : No corresponding specification

Product Discontinuation and recommended replacement

Product discontinuation S82K Series				Recommended replacement S8VS Series			
Power ratings	Output voltage	Output current	Model	Power ratings	Output voltage	Output current	Model
3W	5V	0.6A	S82K-00305	15W	5V	2A	S8VS-01505
	12V	0.25A	S82K-00312		12V	1.2A	S8VS-01512
	15V	0.2A	S82K-00315		15V	1A	S8JX-G01515CD *4
	24V	0.13A	S82K-00324		24V	0.65A	S8VS-01524
7.5W	5V	1.5A	S82K-00705	15W	5V	2A	S8VS-01505
	12V	0.6A	S82K-00712		12V	1.2A	S8VS-01512
	15V	0.5A	S82K-00715		15V	1A	S8JX-G01515CD *1
	24V	0.3A	S82K-00724		24V	0.65A	S8VS-01524
	±12V	0.3A 0.2A	S82K-00727		12V	1.2A	S8VS-01512 *1 2 units
	±15V	0.2A 0.2A	S82K-00728		15V	1A	S8JX-G01515CD *1,*4 2 units
15W	5V	2.5A	S82K-01505	15W	5V	2A	S8VS-01505 *2
	12V	1.2A	S82K-01512		12V	1.2A	S8VS-01512
	24V	0.6A	S82K-01524		24V	0.65A	S8VS-01524
30W	5V	5A	S82K-03005	30W	5V	4A	S8VS-03005 *3
	12V	2.5A	S82K-03012		12V	2.5A	S8VS-03012
	24V	1.3A	S82K-03024		24V	1.3A	S8VS-03024
50W	24V	2.1A	S82K-05024	60W	24V	2.5A	S8VS-06024 S8VS-06024□ *5
90W	24V	3.75A	S82K-09024 S82K-P09024	90W	24V	3.75A	S8VS-09024 S8VS-09024S *7 S8VS-09024□□ *6
100W	24V	4.2A	S82K-10024 S82K-P10024	120W	24V	5A	S8VS-12024 S8VS-12024□□ *6

*1. Generating (±) output by two-set connection. (Please refer to "Wire Connection" for details.)

*2. The output capacity is 10W (2A).

*3. The output capacity is 20W (4A).

*4. Undervoltage alarm indication is not available.

*5. Undervoltage alarm indication is available.

*6. Undervoltage alarm indication and Undervoltage alarm output are available.

*7. UL Class 2 on-specification product (S8VS-15W, 30W, and 60W models are UL Class 2 standard conformity)

Dimensions and Mounting dimensions

Product discontinuation

S82K Series

<3W,7.5W Models>

S82K-003□□ (3W)

S82K-007□□ (7.5W)

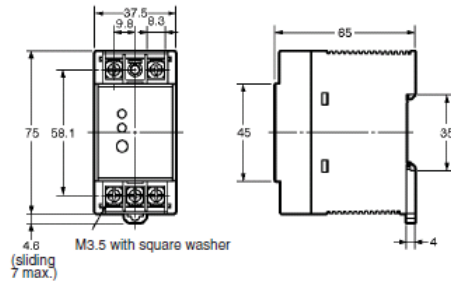
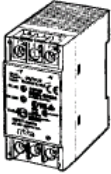

<15W Model>

S82K-015□□ (15W)

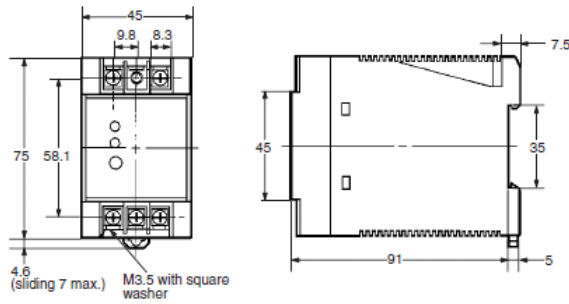
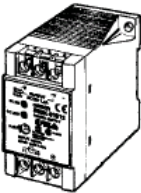

<30W,50W Models>

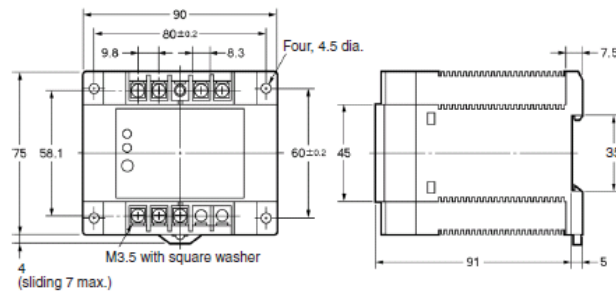
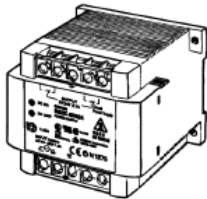

<90W,100W Models>

S82K-□09024 (90W)

S82K-□10024 (100W)

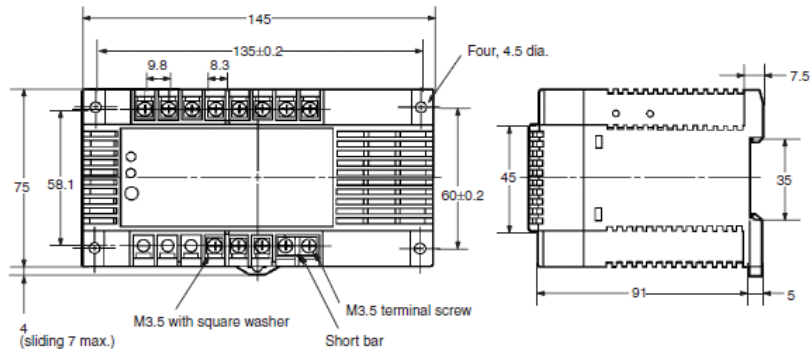
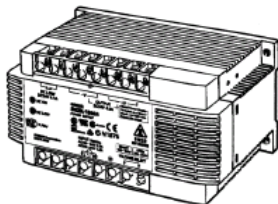

Recommended replacement

S8VS Series

<15W(5V,12V,24V),30W Models>

S8VS-015□□ (15W)

S8VS-030□□ (30W)

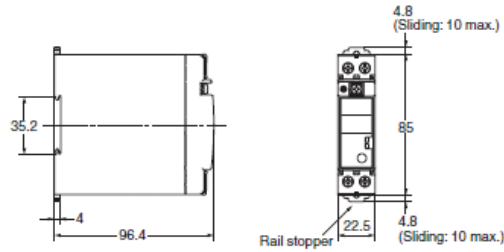

<15W(15V) Model>

S8JX-G01515CD (15W)

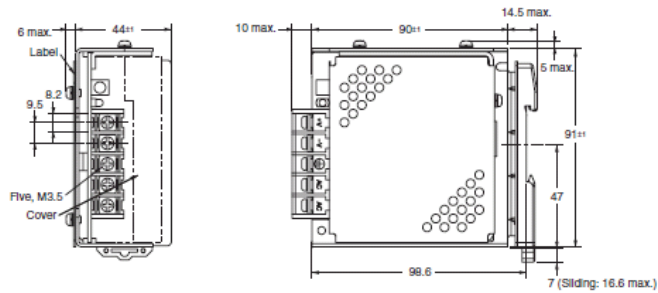

<60W Model>

S8VS-06024 (60W)

S8VS-06024□ (60W)

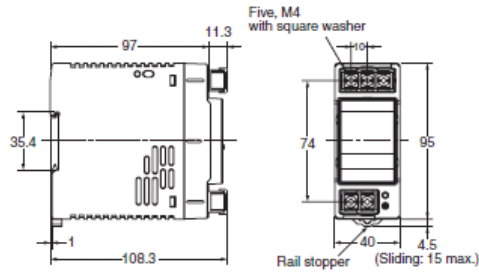

<90W,120W Models>

S8VS-09024 (90W)

S8VS-09024□□ (90W)

S8VS-09024S (90W)

S8VS-12024□□ (120W)

S8VS-12024 (120W)

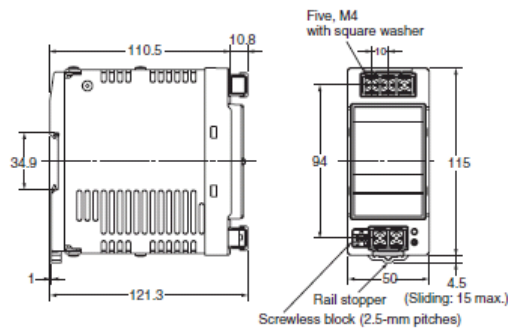

Product discontinuation

S82K Series

<3W,7.5W(Single output) Models>

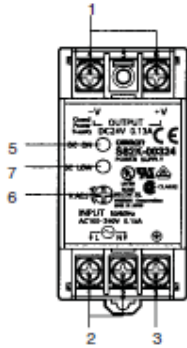

<7.5W(Dual outputs) Model>

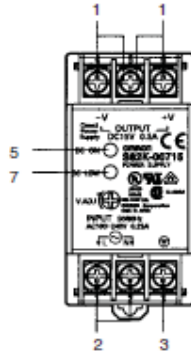

<15W Model>

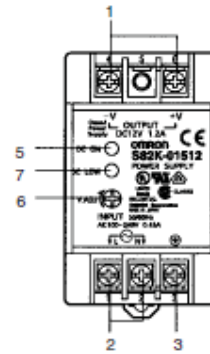

<30W,50W Models>

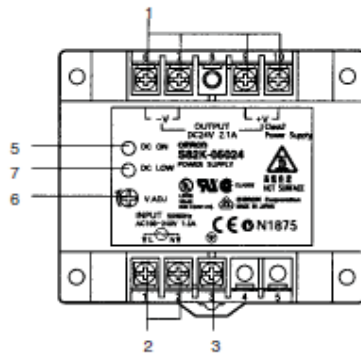

<90W,100W Models>

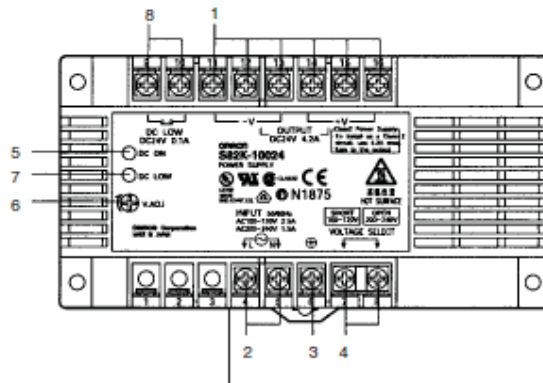

Parallel/Single
Operation Selector
(Only for S82K-
P10024)

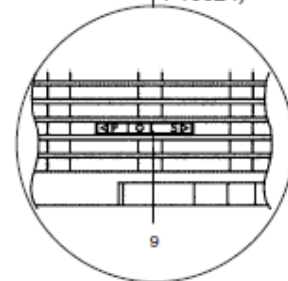

1. **DC Output Terminals:** Connect the load lines to these terminals.
2. **Input Terminals:** Connect the input lines to these terminals.
3. **Protective Earthing Terminals (PE):** Connect a ground line to these terminals.
4. **Input Voltage Selector Terminals (VOLTAGE SELECT):** Selects a 100 V or 200 V input voltage.
5. **Output Indicator (DC ON: green):** Lights while a Direct Current (DC) output is ON.
6. **Output Voltage Adjuster(V.ADJ):** Use to adjust the voltage.
7. **Undervoltage Alarm Indicator Terminal (DC LOW: red):** Lights when there is a drop in the output voltage.
8. **Undervoltage Alarm Output Terminals (DC LOW):** S82K-□09024/-□10024 only.
9. **Parallel/Single Operation Selector:** Set to "PARALLEL" for parallel operation.

Recommended replacement

S8VS Series

<15W(5V,12V,24V),30W Models>

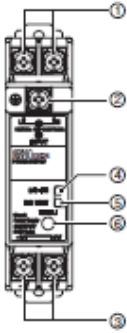

No.	Name	Function
1	AC Input terminals (L), (N)	Connect the input lines to these terminals. (See note 1.)
2	Protective Earth terminal (PE)	Connect the ground line to this terminal. (See note 2.)
3	DC Output terminals (-V), (+V)	Connect the load lines to these terminals.
4	Output indicator (DC ON: Green)	Lights while a direct current (DC) output is ON.
5	Undervoltage indicator (DC LOW: Red)	Lights when a drop is detected in the output voltage.
6	Output voltage adjuster (V.ADJ)	Use to adjust the voltage.

Note: 1. The fuse is located on the (L) side. It is NOT user-replaceable.

2. This is the protective earth terminal specified in the safety standards. Always ground this terminal.

<15W(15V) Model>

S8JX-G01515CD

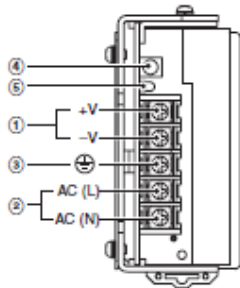

No.	Name	Function
1	DC Output Terminals (-V), (+V)	Connect the load lines to these terminals.
2	AC Input Terminals (L), (N)	Connect the input lines to these terminals. *1
3	Protective Earth Terminal (PE) (⊕)	Connect the ground line to these terminals. *2
4	Output Voltage Adjuster (V. ADJ)	Use to adjust the voltage.
5	Output Indicator (DC ON: Green)	Lights green while a direct current (DC) output is ON.

*1. The fuse is located on the (L) side. It is NOT user-replaceable.

*2. This is the protective earth terminal specified in the safety standards. Always ground this terminal.

<15W(±12V, ±15V) Models>

S8VS-01512 2 units

S8JX-G01515CD 2 units

Two power supplies can be connected in series.

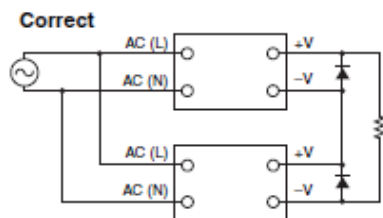

Note: 1. The diode is connected as shown in the figure. If the load is short-circuited, a reverse voltage will be generated inside the Power Supply. If this occurs the Power Supply may possibly deteriorate or be damaged. Always connect a diode as shown in the figure.

Select a diode having the following ratings.

Type	Schottky Barrier diode
Dielectric strength (VRRM)	Twice the rated output voltage or above
Forward current (IF)	Twice the rated output current or above

<60W Model>

S8VS-06024 (60W)

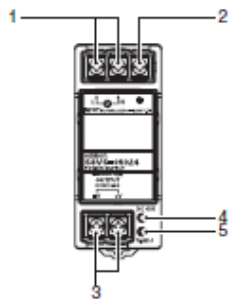

S8VS-06024□ (60W)

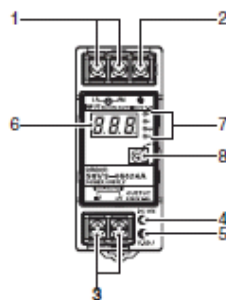

<90W,120W Models>

S8VS-09024 (90W)

S8VS-09024S (90W)

S8VS-12024 (120W)

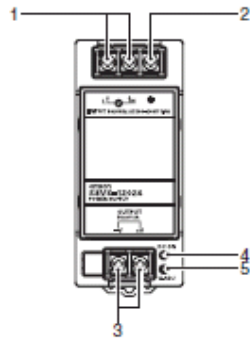

S8VS-09024□□ (90W)

S8VS-12024□□ (120W)

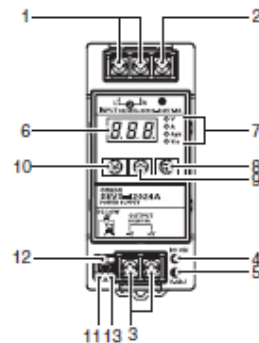

No.	Name	Function	
1	AC Input terminals (L), (N)	Connect the input lines to these terminals. (See note 1.)	
2	Protective Earth terminal (PE)	Connect the ground line to this terminal. (See note 2.)	
3	DC Output terminals (-V), (+V)	Connect the load lines to these terminals.	
4	Output indicator (DC ON: Green)	Lights while a direct current (DC) output is ON.	
5	Output voltage adjuster (V.ADJ)	Use to adjust the voltage.	
6	Main display (Red) (See note 3.)	Indicates the measurement or set value.	
7	Operation indicator (Orange) (See note 3.)	V	Lights up when the output voltage is indicated. Blinks during setup of undervoltage alarm value.
		A	Lights up during indication of output current.
		Apk	Lights up during indication of peak hold current.
		Yrs	Lights up during indication of maintenance forecast monitor. Blinks during setup of maintenance forecast monitor setting. (S8VS-□□□24A□)
7	Operation indicator (Orange) (See note 3.)	kh	Lights up during indication of total run time monitor. Blinks during setup of total run time monitor. (S8VS-□□□24B□)
8	Mode Key (See note 3.)	Use the Mode Key to change the indicated parameter or reset the peak hold current value.	
9	Up Key (See note 4.)	Use the Up Key to change to the setting mode or to increase the set value.	
10	Down Key (See note 4.)	Use the Down Key to change to the setting mode or to decrease the set value.	
11	Alarm outputs (See notes 4 and 5.)	Undervoltage output terminal (DC Low) Output when a drop is detected in the output voltage (voltage drop = transistor OFF).	
12	Maintenance Forecast output terminal (Yrs) (See note 6.)	Total run time output terminal (kh) (See note 7.)	Output when the set value for maintenance is reached (transistor OFF).
			Output when the set value for total run time is reached (transistor OFF).
13	Common terminal	Common terminal (emitter) for terminals 11 and 12.	

- Note:** 1. The fuse is located on the (L) side. It is NOT user replaceable.
 2. This is the protective earth terminal specified in the safety standards. Always ground this terminal.
 3. S8VS-□□□24A□/B□ only.
 4. S8VS-□□□24A□/B□ only (excluding S8VS-06024□).
 5. Both sinking and sourcing outputs are available.
 6. S8VS-□□□24A□ only (excluding S8VS-06024A).
 7. S8VS-□□□24B□ only (excluding S8VS-06024B).

Characteristics

	Product discontinuation S82K Series	Recommended replacement S8VS Series
Input Voltage	3W,7.5W,15W,30W,50W models 100 to 240 VAC (85 to 264 VAC) (free) 90 to 350 VDC (3W,7.5W,15W only) 90W,100W models 100 to 120 VAC (85 to 132 VAC) / 200 to 240 VAC (170 to 264 VAC) (selectable)	All models 100 to 240 VAC (85 to 264 VAC) (free)
Inrush Current	3W,7.5W,15W models 15A max. (100V input) 30A max. (200V input) 30W,50W,90W,100W models 25A max. (100V input) 50A max. (200V input) *for cold start at 25 °C	15W(5V,12V,24V),30W,60W,90W,120W models 25A max. (100V input) 50A max. (200V input) 15W(15V) model (S8JX-G01515CD) 20A max. (100V input) 40A max. (200V input) *for cold start at 25 °C
Startup time	3W,7.5W,15W,30W,50W models 100ms max. 90W,100W models 200ms max.	15W(5V,12V,24V) models 100ms max. 15W(15V) model (S8JX-G01515CD) 500ms max. 30W,60W,90W,120W models 1000ms max.
Hold time	All models 20ms min.	All models 20ms min.
Overload protection	3W,7.5W(single output),15W models 105 to 160% of rated load current, gradual current/voltage drop, automatic reset 7.5W(dual outputs) model 105 to 250% of rated load current, gradual current/voltage drop, automatic reset 30W,50W models 105 to 160% of rated load current, gradual current increase, voltage drop, intermittent, automatic reset 90W,100W models 105 to 160% of rated load current, inverted L drop, automatic reset	15W(5V,12V,24V) models 105 to 160% of rated load current, voltage drop, automatic reset 15W(15V) model (S8JX-G01515CD) 105 to 160% of rated load current, voltage drop, intermittent, automatic reset 30W,60W,90W models 105 to 160% of rated load current, voltage drop, intermittent, automatic reset 120W model 105 to 160% of rated load current, voltage drop, automatic reset
Parallel operation	3W,7.5W,15W,30W,50W,90W models No 100W model Yes (up to 2 units)	All models No
Cooling method	All models Natural air-cooling	All models Natural air-cooling