

TLC1078, TLC1078Y, TLC1079, TLC1079Y LinCMOS™ μ POWER PRECISION OPERATIONAL AMPLIFIERS

SLOS179A – FEBRUARY 1997 – REVISED MARCH 2001

- Power Dissipation as Low as 10 μ W Typ Per Amplifier
- Operates on a Single Silver-Oxide Watch Battery, $V_{DD} = 1.4$ V Min
- $V_{IO} \dots 450 \mu\text{V}/850 \mu\text{V}$ Max in DIP and Small-Outline Package (TLC1078/79)
- Input Offset Voltage Drift $\dots 0.1 \mu\text{V}/\text{Month}$ Typ, Including the First 30 Days
- High-impedance LinCMOS™ Inputs
 $I_{IB} = 0.6$ pA Typ
- High Open-Loop Gain $\dots 800000$ Typ
- Output Drive Capability > 20 mA
- Slew Rate $\dots 47$ V/ms Typ
- Common-Mode Input Voltage Range Extends Below the Negative Rail
- Output Voltage Range Includes Negative Rail
- On-Chip ESD-Protection Circuitry
- Small-Outline Package Option Also Available in Tape and Reel

description

The TLC107x operational amplifiers offer ultra-low offset voltage, high gain, 110-kHz bandwidth, 47-V/ms slew rate, and just 150- μ W power dissipation per amplifier.

With a supply voltage of 1.4 V, common-mode input to the negative rail, and output swing to the negative rail, the TLC107xC is an ideal solution for low-voltage battery-operated systems. The 20-mA output drive capability means that the TLC107x can easily drive small resistive and large capacitive loads when needed, while maintaining ultra-low standby power dissipation.

Since this device is functionally compatible as well as pin compatible with the TLC27L2/4 and TLC27L7/9, the TLC107x easily upgrades existing designs that can benefit from its improved performance.

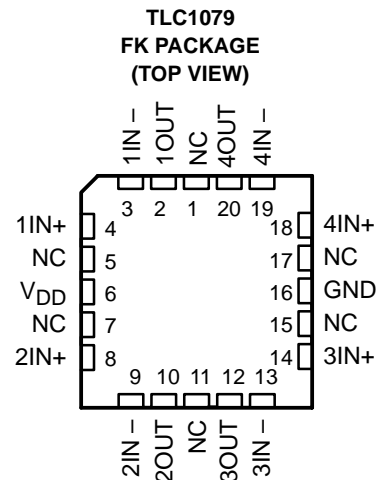
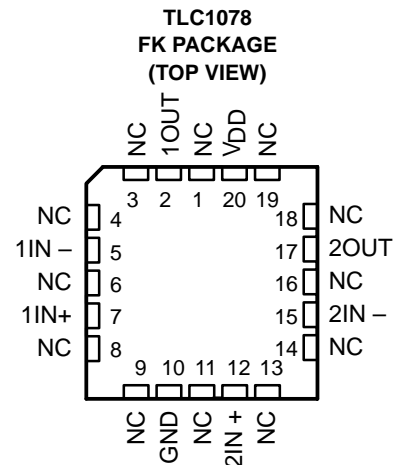
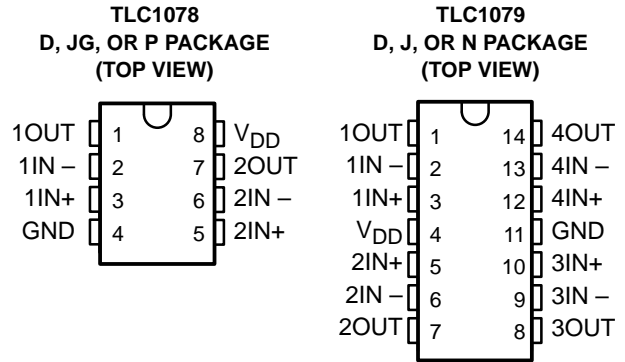

NC – No internal connection



Please be aware that an important notice concerning availability, standard warranty, and use in critical applications of Texas Instruments semiconductor products and disclaimers thereto appears at the end of this data sheet.

LinCMOS is a trademark of Texas Instruments Incorporated.

PRODUCTION DATA information is current as of publication date. Products conform to specifications per the terms of Texas Instruments standard warranty. Production processing does not necessarily include testing of all parameters.



Copyright © 2001, Texas Instruments Incorporated

TLC1078, TLC1078Y, TLC1079, TLC1079Y

LinCMOS™ μ POWER PRECISION OPERATIONAL AMPLIFIERS

SLOS179A – FEBRUARY 1997 – REVISED MARCH 2001

description (continued)

The TLC107x incorporates internal ESD-protection circuits that will prevent functional failures at voltages up to 2000 V as tested under MIL-PRF-38535, Method 3015.2; however, care should be exercised when handling these devices as exposure to ESD may result in degradation of the device parametric performance. The TLC107x design also inhibits latch-up of the device inputs and outputs even with surge currents as large 100 mA.

The C-suffix devices are characterized for operation from 0°C to 70°C. The I-suffix devices are characterized for operation from –40°C to 85°C. The M-suffix devices are characterized for operation over the full military temperature range of –55°C to 125°C. The wide range of packaging options includes small-outline and chip-carrier versions for high-density system applications.

AVAILABLE OPTIONS

T _A	PACKAGED DEVICES						CHIP FORM‡ (Y)
	SMALL OUTLINE† (D)	CHIP CARRIER (FK)	CERAMIC DIP (J)	CERAMIC DIP (JG)	PLASTIC DIP (N)	PLASTIC DIP (P)	
0°C to 70°C	TLC1078CD TLC1079CD	—	—	—	TLC1079CN	TLC1078CP	TLC1078Y TLC1079Y
–40°C to 85°C	TLC1078ID TLC1079ID	—	—	—	TLC1079IN	TLC1078IP	—
–55°C to 125°C	TLC1078MD TLC1079MD	TLC1078MFK TLC1079MFK	TLC1079MJ	TLC1078MJG	TLC1079MN	TLC1078MP	—

† The D package is available taped and reeled. Add the suffix R to the device type (e.g., TLC1078CDR).

‡ Chip forms are tested 25°C only.

symbol (each amplifier)

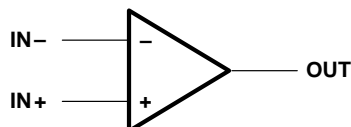

TLC1087Y chip information

This chip, when properly assembled, displays characteristics similar to the TLC1078C. Thermal compression or ultrasonic bonding may be used on the doped-aluminum bonding pads. Chips can be mounted with conductive epoxy or a gold-silicon preform.

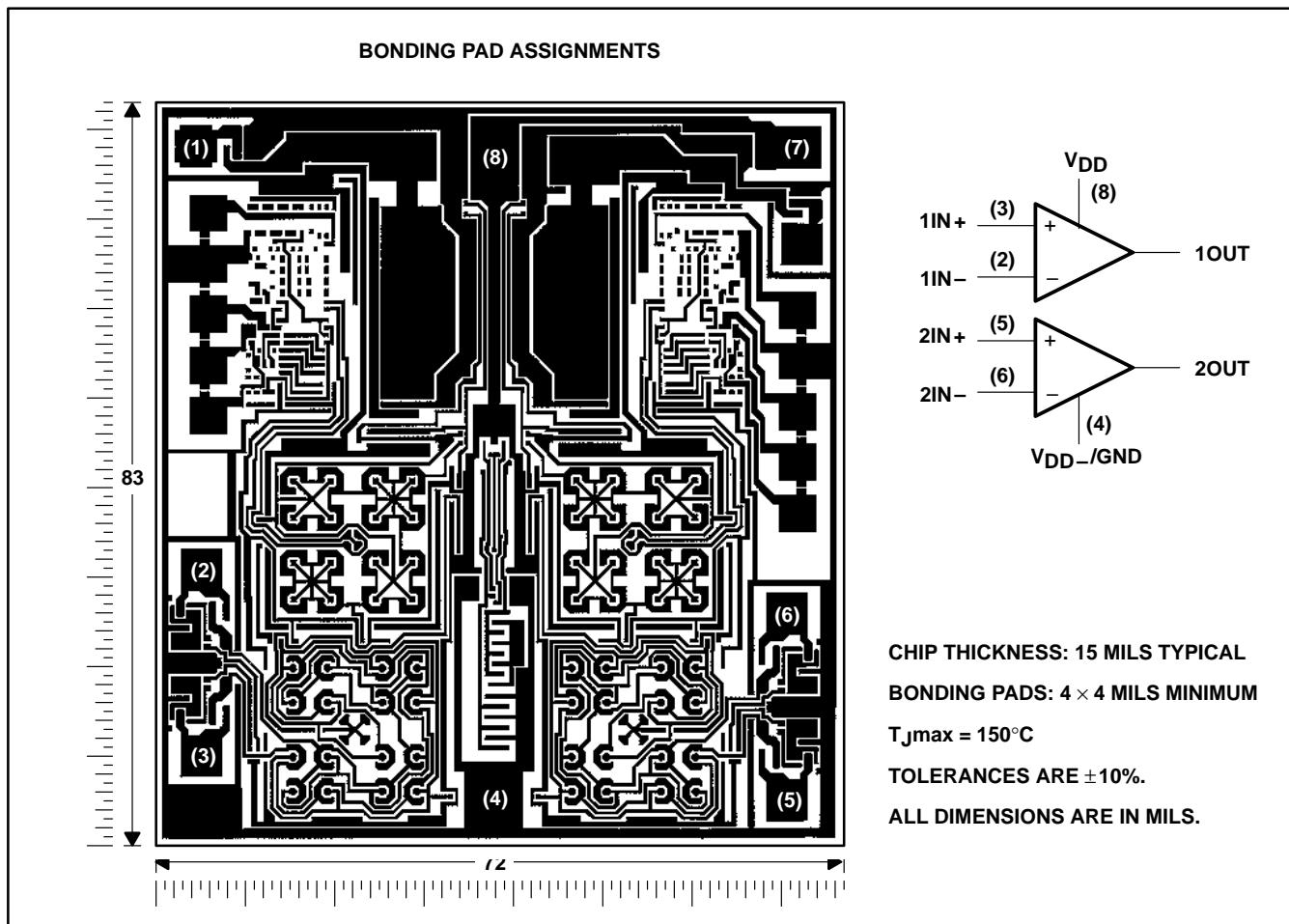

TLC1078, TLC1078Y, TLC1079, TLC1079Y
LinCMOS™ μ POWER PRECISION
OPERATIONAL AMPLIFIERS

SLOS179A – FEBRUARY 1997 – REVISED MARCH 2001

TLC1079Y chip information

This chip, when properly assembled, display characteristics similar to the TLC1079C. Thermal compression or ultrasonic bonding may be used on the doped-aluminum bonding pads. Chips can be mounted with conductive epoxy or a gold-silicon preform.

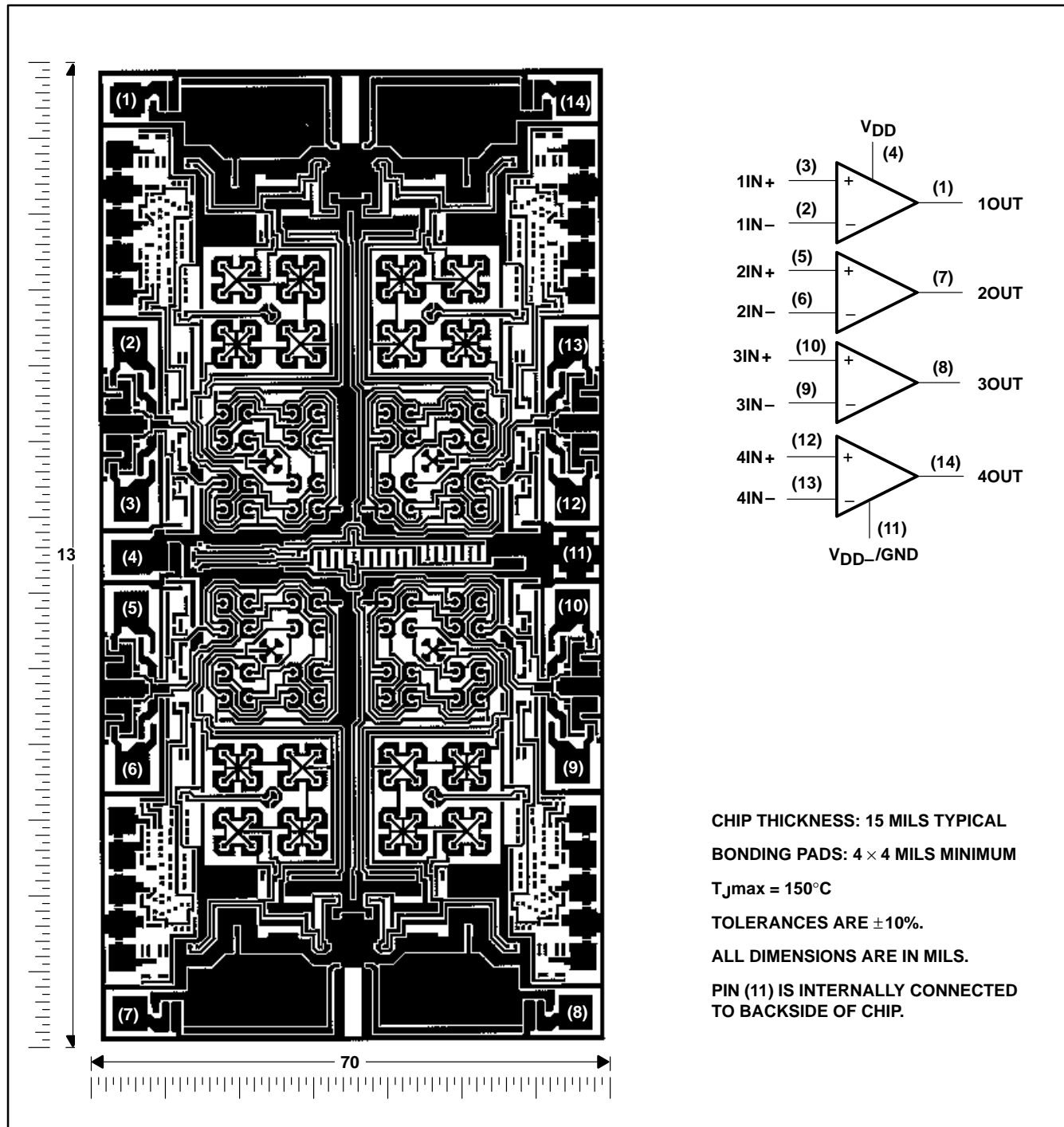

equivalent schematic (each amplifier)

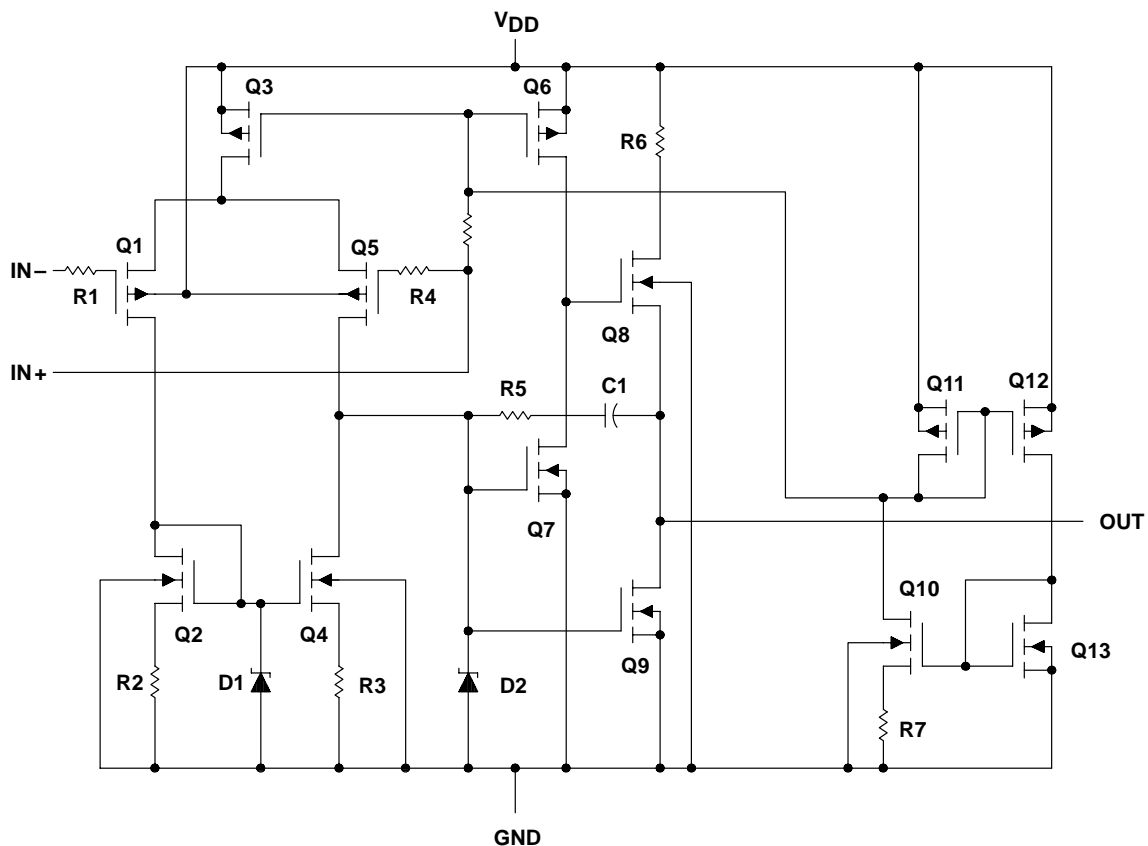

ACTUAL DEVICE COMPONENT COUNT		
COMPONENT	TLC1078	TLC1079
Transistors	38	76
Resistors	16	32
Diodes	12	24
Capacitors	2	4

absolute maximum ratings over operating free-air temperature range (unless otherwise noted)†

Supply voltage, V_{DD} (see Note 1)	18 V
Differential input voltage, V_{ID} (see Note 2)	$\pm V_{DD}$
Input voltage range, V_I (any input)	-0.3 V to V_{DD}
Input current, I_I (each input)	± 5 mA
Output current, I_O (each output)	± 30 mA
Total current into V_{DD} (see Note 3)	45 mA
Duration of short-circuit at (or below) $T_A = 25^\circ\text{C}$ (see Note 3)	unlimited
Continuous total power dissipation	see Dissipation Rating Table
Operating free-air temperature range, T_A : C suffix	0°C to 70°C
I suffix	-40°C to 85°C
M suffix	-55°C to 125°C
Storage temperature range	-65°C to 150°C
Case temperature for 60 seconds: FK package	260°C
Lead temperature 1,6 mm (1/16 inch) from case for 10 seconds: D or P package	260°C
Lead temperature 1,6 mm (1/16 inch) from case for 60 seconds: JG package	300°C

† Stresses beyond those listed under “absolute maximum ratings” may cause permanent damage to the device. These are stress ratings only, and functional operation of the device at these or any other conditions beyond those indicated under “recommended operating conditions” is not implied. Exposure to absolute-maximum-rated conditions for extended periods may affect device reliability.

- NOTES: 1. All voltage values, except differential voltages, are with respect to network ground.
 2. Differential voltages are at $IN+$ with respect to $IN-$.
 3. The output may be shorted to either supply. Temperature and/or supply voltages must be limited to ensure that the maximum dissipation ratings are not exceeded.

DISSIPATION RATING TABLE

PACKAGE	$T_A \leq 25^\circ\text{C}$ POWER RATING	DERATING FACTOR ABOVE $T_A = 25^\circ\text{C}$	$T_A = 70^\circ\text{C}$ POWER RATING	$T_A = 85^\circ\text{C}$ POWER RATING	$T_A = 125^\circ\text{C}$ POWER RATING
D-8	725 mW	5.8 mW/ $^\circ\text{C}$	464 mW	377 mW	145 mW
D-14	950 mW	7.6 mW/ $^\circ\text{C}$	608 mW	494 mW	190 mW
FK	1375 mW	11.0 mW/ $^\circ\text{C}$	880 mW	715 mW	275 mW
J	1375 mW	11.0 mW/ $^\circ\text{C}$	880 mW	715 mW	275 mW
JG	1050 mW	8.4 mW/ $^\circ\text{C}$	672 mW	546 mW	210 mW
N	1150 mW	9.2 mW/ $^\circ\text{C}$	736 mW	598 mW	230 mW
P	1000 mW	8.0 mW/ $^\circ\text{C}$	640 mW	520 mW	200 mW

recommended operating conditions

		C SUFFIX		I SUFFIX		M SUFFIX		UNIT
		MIN	MAX	MIN	MAX	MIN	MAX	
Supply voltage, V_{DD}		1.4	16	3	16	4	16	V
Common-mode input voltage, V_{IC}	$V_{DD} = 5$ V	-0.2	4	-0.2	4	0	4	V
	$V_{DD} = 10$ V	-0.2	9	-0.2	9	0	9	
Operating free-air temperature, T_A		0	70	-40	85	-55	125	$^\circ\text{C}$



electrical characteristics at specified free-air temperature

PARAMETER	TEST CONDITIONS	T _A †	TLC1078C						UNIT
			V _{DD} = 5 V			V _{DD} = 10 V			
			MIN	TYP	MAX	MIN	TYP	MAX	
V _{IO}	Input offset voltage	V _O = 1.4 V, R _S = 50 Ω , V _{IC} = 0, R _I = 1 M Ω	25°C	160	450	180	600	μ V	
α V _{IO}	Temperature coefficient of input offset voltage	25°C to 70°C	1.1			1			μ V/°C
I _{IO}	Input offset current (see Note 4)	V _O = V _{DD} /2, V _{IC} = V _{DD} /2	25°C	0.1	60	0.1	60	pA	
I _{IB}	Input bias current (see Note 4)	70°C	7	300	7	300	pA		
V _{ICR}	Common-mode input voltage range (see Note 5)	25°C	-0.2 to 4		-0.3 to 4.2		-0.2 to 9		V
			Full range		-0.2 to 3.5		-0.2 to 8.5		V
V _{OH}	High-level output voltage	V _{ID} = 100 mV, R _L = 1 M Ω	25°C	3.2	4.1	8.2	8.9	V	
			0°C	3.2	4.1	8.2	8.9	V	
			70°C	3.2	4.2	8.2	8.9	V	
V _{OL}	Low-level output voltage	V _{ID} = -100 mV, I _{OL} = 0	25°C	0	25	0	25	mV	
			0°C	0	25	0	25	mV	
			70°C	0	25	0	25	mV	
A _{VD}	Large-signal differential voltage amplification	R _L = 1 M Ω , See Note 6	25°C	250	525	500	850	V/mV	
			0°C	250	680	500	1010	V/mV	
			70°C	200	380	350	660	V/mV	
CMRR	Common-mode rejection ratio	V _{IC} = V _{ICRmin}	25°C	70	95	75	97	dB	
			0°C	70	95	75	97	dB	
			70°C	70	95	75	97	dB	
k _{SVR}	Supply-voltage rejection ratio (Δ V _{DD} / Δ V _{IO})	V _O = 1.4 V	25°C	75	98	75	98	dB	
			0°C	75	98	75	98	dB	
			70°C	75	98	75	98	dB	
I _{DD}	Supply current (two amplifiers)	V _O = V _{DD} /2, V _{IC} = V _{DD} /2, No load	25°C	20	34	29	46	μ A	
			0°C	24	42	36	66	μ A	
			70°C	16	28	22	40	μ A	

† Full range is 0°C to 70°C.

- NOTES: 4. The typical values of input bias current and input offset current below 5 pA were determined mathematically.
 5. This range also applies to each input individually.
 6. At V_{DD} = 5 V, V_O = 0.25 V to 2 V; at V_{DD} = 10 V, V_O = 1 V to 6 V.

TLC1078, TLC1078Y, TLC1079, TLC1079Y
LinCMOS™ μ POWER PRECISION
OPERATIONAL AMPLIFIERS

SLOS179A – FEBRUARY 1997 – REVISED MARCH 2001

electrical characteristics at specified free-air temperature

PARAMETER	TEST CONDITIONS	T_A †	TLC1079C						UNIT
			$V_{DD} = 5\text{ V}$			$V_{DD} = 10\text{ V}$			
			MIN	TYP	MAX	MIN	TYP	MAX	
V_{IO} Input offset voltage	$V_O = 1.4\text{ V}, V_{IC} = 0,$ $R_S = 50\ \Omega, R_I = 1\text{ M}\Omega$	25°C	190	850	200	1150	μV		
Full range		1200			1500				
α_{VIO} Temperature coefficient of input offset voltage		25°C to 70°C	1.1			1		$\mu\text{V}/^\circ\text{C}$	
I_{IO} Input offset current (see Note 4)	$V_O = V_{DD}/2,$ $V_{IC} = V_{DD}/2$	25°C	0.1	60	0.1	60	pA		
		70°C	7	300	7	300			
I_{IB} Input bias current (see Note 4)		25°C	0.6	60	0.7	60	pA		
		70°C	40	600	50	600			
V_{ICR} Common mode input voltage range (see Note 5)		25°C	-0.2 to 4	-0.3 to 4.2	-0.2 to 9	-0.3 to 9.2	V		
	Full range		-0.2 to 3.5		-0.2 to 8.5		V		
V_{OH} High-level output voltage	$V_{ID} = 100\text{ mV},$ $R_L = 1\text{ M}\Omega$	25°C	3.2	4.1	8.2	8.9	V		
		0°C	3.2	4.1	8.2	8.9			
		70°C	3.2	4.2	8.2	8.9			
V_{OL} Low-level output voltage	$V_{ID} = -100\text{ mV},$ $I_{OL} = 0$	25°C	0	25	0	25	mV		
		0°C	0	25	0	25			
		70°C	0	25	0	25			
A_{VD} Large-signal differential voltage amplification	$R_L = 1\text{ M}\Omega,$ See Note 6	25°C	250	525	500	850	V/mV		
		0°C	250	700	500	1010			
		70°C	200	380	350	660			
CMRR Common mode rejection ratio	$V_{IC} = V_{ICRmin}$	25°C	70	95	75	97	dB		
		0°C	70	95	75	97			
		70°C	70	95	75	97			
k_{SVR} Supply-voltage rejection ratio ($\Delta V_{DD}/\Delta V_{IO}$)	$V_{DD} = 5\text{ V to }10\text{ V},$ $V_O = 1.4\text{ V}$	25°C	75	98	75	98	dB		
		0°C	75	98	75	98			
		70°C	75	98	75	98			
I_{DD} Supply current (four amplifiers)	$V_O = V_{DD}/2,$ $V_{IC} = V_{DD}/2,$ No load	25°C	40	68	57	92	μA		
		0°C	48	84	72	132			
		70°C	31	56	44	80			

† Full range is 0°C to 70°C.

- NOTES: 4. The typical values of input bias current and input offset current below 5 pA were determined mathematically.
5. This range also applies to each input individually.
6. At $V_{DD} = 5\text{ V}, V_O = 0.25\text{ V to }2\text{ V};$ at $V_{DD} = 10\text{ V}, V_O = 1\text{ V to }6\text{ V}.$



operating characteristics at specified free-air temperature

PARAMETER	TEST CONDITIONS	T _A	TLC1078C						UNIT
			V _{DD} = 5 V			V _{DD} = 10 V			
			MIN	TYP	MAX	MIN	TYP	MAX	
SR Slew rate at unity gain	R _L = 1 M Ω , C _L = 20 pF, V _{I(PP)} = 1 V, See Figure 1	25°C	32			47			V/ms
		0°C	35			51			
		70°C	27			38			
V _n Equivalent input noise voltage	f = 1 kHz, R _S = 20 Ω	25°C	68			68			nV/ $\sqrt{\text{Hz}}$
B ₁ Unity-gain bandwidth	C _L = 20 pF, See Figure 2	25°C	85			110			kHz
		0°C	100			125			
		70°C	65			90			
ϕ_m Phase margin at unity gain	C _L = 20 pF, See Figure 2	25°C	34°			38°			
		0°C	36°			40°			
		70°C	30°			34°			

operating characteristics at specified free-air temperature

PARAMETER	TEST CONDITIONS	T _A	TLC1079C						UNIT
			V _{DD} = 5 V			V _{DD} = 10 V			
			MIN	TYP	MAX	MIN	TYP	MAX	
SR Slew rate at unity gain	R _L = 1 M Ω , C _L = 20 pF, V _{I(PP)} = 1 V, See Figure 1	25°C	32			47			V/ms
		0°C	35			51			
		70°C	27			38			
V _n Equivalent input noise voltage	f = 1 kHz, R _S = 20 Ω	25°C	68			68			nV/ $\sqrt{\text{Hz}}$
B ₁ Unity-gain bandwidth	C _L = 20 pF, See Figure 2	25°C	85			110			kHz
		0°C	100			125			
		70°C	65			90			
ϕ_m Phase margin at unity gain	C _L = 20 pF, See Figure 2	25°C	34°			38°			
		0°C	36°			40°			
		70°C	30°			34°			

TLC1078, TLC1078Y, TLC1079, TLC1079Y
LinCMOS™ μ POWER PRECISION
OPERATIONAL AMPLIFIERS

SLOS179A – FEBRUARY 1997 – REVISED MARCH 2001

electrical characteristics at specified free-air temperature

PARAMETER	TEST CONDITIONS	T _A †	TLC1078I						UNIT
			V _{DD} = 5 V			V _{DD} = 10 V			
			MIN	TYP	MAX	MIN	TYP	MAX	
V _{IO}	Input offset voltage	V _O = 1.4 V, R _S = 50 Ω, V _{IC} = 0, R _I = 1 MΩ	25°C	160	450	180	600	μV	
α _{VIO}	Temperature coefficient of input offset voltage		Full range	950		1100		μV/°C	
I _{IO}	Input offset current (see Note 4)	V _O = V _{DD} /2, V _{IC} = V _{DD} /2	25°C	0.1	60	0.1	60	pA	
I _{IB}	Input bias current (see Note 4)		85°C	24	1000	26	1000	pA	
V _{ICR}	Common-mode input voltage range (see Note 5)		25°C	-0.2 to 4	-0.3 to 4.2	-0.2 to 9	-0.3 to 9.2	V	
			Full range	-0.2 to 3.5		-0.2 to 8.5		V	
V _{OH}	High-level output voltage	V _{ID} = 100 mV, R _L = 1 MΩ	25°C	3.2	4.1	8.2	8.9	V	
			-40°C	3.2	4.1	8.2	8.9		
			85°C	3.2	4.2	8.2	8.9		
V _{OL}	Low-level output voltage	V _{ID} = -100 mV, I _{OL} = 0	25°C	0	25	0	25	mV	
			-40°C	0	25	0	25		
			85°C	0	25	0	25		
A _{VD}	Large-signal differential voltage amplification	R _L = 1 MΩ, See Note 6	25°C	250	525	500	850	V/mV	
			-40°C	250	900	500	1550		
			85°C	150	300	250	585		
CMRR	Common-mode rejection ratio	V _{IC} = V _{ICRmin}	25°C	70	95	75	97	dB	
			-40°C	70	95	75	97		
			85°C	70	95	75	97		
k _{SVR}	Supply-voltage rejection ratio (ΔV _{DD} /ΔV _{IO})	V _O = 1.4 V	25°C	75	98	75	98	dB	
			-40°C	75	98	75	98		
			85°C	75	98	75	98		
I _{DD}	Supply current (two amplifiers)	V _O = V _{DD} /2, V _{IC} = V _{DD} /2, No load	25°C	20	34	29	46	μA	
			-40°C	31	54	50	86		
			85°C	15	26	20	36		

† Full range is -40°C to 80°C.

NOTES: 4. The typical values of input bias current and input offset current below 5 pA were determined mathematically.

5. This range also applies to each input individually.

6. At V_{DD} = 5 V, V_O = 0.25 V to 2 V; at V_{DD} = 10 V, V_O = 1 V to 6 V.



TLC1078, TLC1078Y, TLC1079, TLC1079Y
**LinCMOS™ μ POWER PRECISION
 OPERATIONAL AMPLIFIERS**

SLOS179A – FEBRUARY 1997 – REVISED MARCH 2001

electrical characteristics at specified free-air temperature

PARAMETER	TEST CONDITIONS	T _A †	TLC1079I						UNIT
			V _{DD} = 5 V			V _{DD} = 10 V			
			MIN	TYP	MAX	MIN	TYP	MAX	
V _{IO}	Input offset voltage	V _O = 1.4 V, V _{IC} = 0, R _S = 50 Ω, R _I = 1 MΩ	25°C	190	850	200	1150	μV	
	Full range			1350		1650			
α _{VIO}	Temperature coefficient of input offset voltage		25°C to 85°C	1.1		1		μV/°C	
I _{IO}	Input offset current (see Note 4)	V _O = V _{DD} / 2, V _{IC} = V _{DD} / 2	25°C	0.1	60	0.1	60	pA	
			85°C	24	1000	26	1000		
I _{IB}	Input bias current (see Note 4)		25°C	0.6	60	0.7	60	pA	
			85°C	200	2000	220	2000		
V _{ICR}	Common-mode input voltage range (see Note 5)		25°C	-0.2 to 4	-0.3 to 4.2	-0.2 to 9	-0.3 to 9.2	V	
			Full range	-0.2 to 3.5		-0.2 to 8.5		V	
V _{OH}	High-level output voltage	V _{ID} = 100 mV, R _L = 1 MΩ	25°C	3.2	4.1	8.2	8.9	V	
				-40°C	3.2	4.1	8.2		8.9
				85°C	3.2	4.2	8.2		8.9
V _{OL}	Low-level output voltage	V _{ID} = -100 mV, I _{OL} = 0	25°C		0 25		0 25	mV	
				-40°C		0 25			0 25
				85°C		0 25			0 25
A _{VD}	Large-signal differential voltage amplification	R _L = 1 MΩ, See Note 6	25°C	250	525	500	850	V/mV	
				-40°C	250	900	500		1550
				85°C	150	330	250		585
CMRR	Common-mode rejection ratio	V _{IC} = V _{ICRmin}	25°C	70	95	75	97	dB	
				-40°C	70	95	75		97
				85°C	70	95	75		97
k _{SVR}	Supply-voltage rejection ratio (ΔV _{DD} /ΔV _{IO})	V _{DD} = 5 V to 10 V, V _O = 1.4 V	25°C	75	98	75	98	dB	
				-40°C	75	98	75		98
				85°C	75	98	75		98
I _{DD}	Supply current (four amplifiers)	V _O = V _{DD} / 2, V _{IC} = V _{DD} / 2, No load	25°C	40	68	57	92	μA	
				-40°C	62	108	98		172
				85°C	29	52	40		72

† Full range is -40°C to 85°C.

- NOTES: 4. The typical values of input bias current and input offset current below 5 pA were determined mathematically.
 5. This range also applies to each input individually.
 6. At V_{DD} = 5 V, V_O = 0.25 V to 2 V; at V_{DD} = 10 V, V_O = 1 V to 6 V.



TLC1078, TLC1078Y, TLC1079, TLC1079Y
LinCMOS™ μ POWER PRECISION
OPERATIONAL AMPLIFIERS

SLOS179A – FEBRUARY 1997 – REVISED MARCH 2001

operating characteristics at specified free-air temperature

PARAMETER	TEST CONDITIONS	T _A	TLC1078I						UNIT
			V _{DD} = 5 V			V _{DD} = 10 V			
			MIN	TYP	MAX	MIN	TYP	MAX	
SR Slew rate at unity gain	R _L = 1 M Ω , C _L = 20 pF, V _{I(PP)} = 1 V, See Figure 1	25°C	32			47			V/ms
		-40°C	39			59			
		85°C	25			34			
V _n Equivalent input noise voltage	f = 1 kHz, R _S = 20 Ω	25°C	68			68			nV/ $\sqrt{\text{Hz}}$
B ₁ Unity-gain bandwidth	C _L = 20 pF, See Figure 2	25°C	85			110			kHz
		-40°C	130			155			
		85°C	55			80			
ϕ_m Phase margin at unity gain	C _L = 20 pF, See Figure 2	25°C	34°			38°			
		-40°C	38°			40°			
		85°C	28°			32°			

operating characteristics at specified free-air temperature

PARAMETER	TEST CONDITIONS	T _A	TLC1079I						UNIT
			V _{DD} = 5 V			V _{DD} = 10 V			
			MIN	TYP	MAX	MIN	TYP	MAX	
SR Slew rate at unity gain	R _L = 1 M Ω , C _L = 20 pF, V _{I(PP)} = 1 V, See Figure 1	25°C	32			47			V/ms
		-40°C	39			59			
		85°C	25			34			
V _n Equivalent input noise voltage	f = 1 kHz, R _S = 20 Ω	25°C	68			68			nV/ $\sqrt{\text{Hz}}$
B ₁ Unity-gain bandwidth	C _L = 20 pF, See Figure 2	25°C	85			110			kHz
		-40°C	130			155			
		85°C	55			80			
ϕ_m Phase margin at unity gain	C _L = 20 pF, See Figure 2	25°C	34°			38°			
		-40°C	38°			42°			
		85°C	28°			32°			



TLC1078, TLC1078Y, TLC1079, TLC1079Y
LinCMOS™ μ POWER PRECISION
OPERATIONAL AMPLIFIERS

SLOS179A – FEBRUARY 1997 – REVISED MARCH 2001

electrical characteristics at specified operating free-air temperature

PARAMETER	TEST CONDITIONS	T _A †	TLC1078M						UNIT
			V _{DD} = 5 V			V _{DD} = 10 V			
			MIN	TYP	MAX	MIN	TYP	MAX	
V _{IO} Input offset voltage	V _O = 1.4 V, V _{IC} = 0, R _S = 50 Ω , R _L = 1 M Ω	25°C	160		450	180		600	μ V
		Full range	1250			1400			
α V _{IO} Temperature coefficient of input offset voltage		25°C to 125°C	1.4			1.4			μ V/°C
I _{IO} Input offset current (see Note 4)	V _O = V _{DD} /2, V _{IC} = V _{DD} /2	25°C	0.1	60		0.1	60		pA
		125°C	1.4	15		1.8	15		nA
I _{IB} Input bias current (see Note 4)		25°C	0.6	60		0.7	60		pA
		125°C	9	35		10	35		nA
V _{ICR} Common-mode input voltage range (see Note 5)		25°C	0 to 4	-0.3 to 4.2		0 to 9	-0.3 to 9.2		V
		Full range	0 to 3.5			0 to 8.5			V
V _{OH} High-level output voltage	V _{ID} = 100 mV, R _L = 1 M Ω	25°C	3.2	4.1		8.2	8.9		V
		-55°C	3.2	4.1		8.2	8.8		
		125°C	3.2	4.2		8.2	9		
V _{OL} Low-level output voltage	V _{ID} = -100 mV, I _{OL} = 0	25°C		0	25		0	25	mV
		-55°C		0	25		0	25	
		125°C		0	25		0	25	
A _{VD} Large-signal differential voltage amplification	R _L = 1 M Ω , See Note 6	25°C	250	525		500	850		V/mV
		-55°C	250	950		500	1750		
		125°C	35	200		75	380		
CMRR Common-mode rejection ratio	V _{IC} = V _{ICRmin}	25°C	70	95		75	97		dB
		-55°C	70	95		75	97		
		125°C	70	85		75	91		
k _{SVR} Supply-voltage rejection ratio (Δ V _{DD} /ΔV _{IO})	V _O = 1.4 V	25°C	75	98		75	98		dB
		-55°C	70	98		70	98		
		125°C	70	98		70	98		
I _{DD} Supply current (two amplifiers)	V _O = V _{DD} /2, V _{IC} = V _{DD} /2, No load	25°C		20	34		29	46	μ A
		-55°C		35	60		56	96	
		125°C		14	24		18	30	

† Full range is -55°C to 125°C.

- NOTES: 4. The typical values of input bias current and input offset current below 5 pA were determined mathematically.
5. This range also applies to each input individually.
6. At V_{DD} = 5 V, V_O = 0.25 V to 2 V; at V_{DD} = 10 V, V_O = 1 V to 6 V.



TLC1078, TLC1078Y, TLC1079, TLC1079Y
LinCMOS™ μ POWER PRECISION
OPERATIONAL AMPLIFIERS

SLOS179A – FEBRUARY 1997 – REVISED MARCH 2001

electrical characteristics at specified free-air temperature

PARAMETER	TEST CONDITIONS	T_A †	TLC1079M						UNIT
			$V_{DD} = 5\text{ V}$			$V_{DD} = 10\text{ V}$			
			MIN	TYP	MAX	MIN	TYP	MAX	
V_{IO} Input offset voltage	$V_O = 1.4\text{ V}, V_{IC} = 0,$ $R_S = 50\ \Omega, R_I = 1\text{ M}\Omega$	25°C	190 850		200 1150		μV		
Full range		1600		1900					
α_{VIO} Temperature coefficient of input offset voltage		25°C to 125°C	1.4		1.4		$\mu\text{V}/^\circ\text{C}$		
I_{IO} Input offset current (see Note 4)	$V_O = V_{DD}/2,$ $V_{IC} = V_{DD}/2$	25°C	0.1	60	0.1	60	pA		
		125°C	1.4	15	1.8	15	nA		
I_{IB} Input bias current (see Note 4)		25°C	0.6	60	0.7	60	pA		
		125°C	9	35	10	35	nA		
V_{ICR} Common mode input voltage range (see Note 5)		25°C	0 to 4	-0.3 to 4.2	0 to 9	-0.3 to 9.2	V		
	Full range		0 to 3.5		0 to 8.5		V		
V_{OH} High-level output voltage	$V_{ID} = 100\text{ mV},$ $R_L = 1\text{ M}\Omega$	25°C	3.2	4.1	8.2	8.9	V		
		-55°C	3.2	4.1	8.2	8.9			
		125°C	3.2	4.2	8.2	9			
V_{OL} Low-level output voltage	$V_{ID} = -100\text{ mV},$ $I_{OL} = 0$	25°C	0 25		0 25		mV		
		-55°C	0 25		0 25				
		125°C	0 25		0 25				
A_{VD} Large-signal differential voltage amplification	$R_L = 1\text{ M}\Omega,$ See Note 6	25°C	250	525	500	850	V/mV		
		-55°C	250	950	500	1750			
		125°C	35	200	75	380			
CMRR Common-mode rejection ratio	$V_{IC} = V_{ICRmin}$	25°C	70	95	75	97	dB		
		-55°C	70	95	75	97			
		125°C	70	85	75	91			
k_{SVR} Supply voltage rejection ratio ($\Delta V_{DD}/\Delta V_{IO}$)	$V_{DD} = 5\text{ V to }10\text{ V},$ $V_O = 1.4\text{ V}$	25°C	75	98	75	98	dB		
		-55°C	70	98	70	98			
		125°C	70	98	70	98			
I_{DD} Supply current (four amplifiers)	$V_O = V_{DD}/2,$ $V_{IC} = V_{DD}/2,$ No load	25°C	40	68	57	92	μA		
		-55°C	69	120	111	192			
		125°C	27	48	35	60			

† Full range is -55°C to 125°C.

NOTES: 4. The typical values of input bias current and input offset current below 5 pA were determined mathematically.

5. This range also applies to each input individually.

6. At $V_{DD} = 5\text{ V}, V_O = 0.25\text{ V to }2\text{ V};$ at $V_{DD} = 10\text{ V}, V_O = 1\text{ V to }6\text{ V}.$



operating characteristics at specified free-air temperature

PARAMETER	TEST CONDITIONS	T_A	TLC1078M						UNIT
			$V_{DD} = 5\text{ V}$			$V_{DD} = 10\text{ V}$			
			MIN	TYP	MAX	MIN	TYP	MAX	
SR Slew rate at unity gain	$R_L = 1\text{ M}\Omega$, $C_L = 20\text{ pF}$, $V_{I(PP)} = 1\text{ V}$, See Figure 1	25°C	32			47			V/ms
		-55°C	41			63			
		125°C	20			27			
V_n Equivalent input noise voltage	$f = 1\text{ kHz}$, $R_S = 20\ \Omega$	25°C	68			68			nV/ $\sqrt{\text{Hz}}$
B_1 Unity-gain bandwidth	$C_L = 20\text{ pF}$, See Figure 2	25°C	85			110			kHz
		-55°C	140			165			
		125°C	45			70			
ϕ_m Phase margin at unity gain	$C_L = 20\text{ pF}$, See Figure 2	25°C	34°			38°			
		-55°C	39°			43°			
		125°C	25°			29°			

operating characteristics at specified free-air temperature

PARAMETER	TEST CONDITIONS	T_A	TLC1079M						UNIT
			$V_{DD} = 5\text{ V}$			$V_{DD} = 10\text{ V}$			
			MIN	TYP	MAX	MIN	TYP	MAX	
SR Slew rate at unity gain	$R_L = 1\text{ M}\Omega$, $C_L = 20\text{ pF}$, $V_{I(PP)} = 1\text{ V}$, See Figure 1	25°C	32			47			V/ms
		-55°C	41			63			
		125°C	20			27			
V_n Equivalent input noise voltage	$f = 1\text{ kHz}$, $R_S = 20\ \Omega$	25°C	68			68			nV/ $\sqrt{\text{Hz}}$
B_1 Unity-gain bandwidth	$C_L = 20\text{ pF}$, See Figure 2	25°C	85			110			kHz
		-55°C	140			165			
		125°C	45			70			
		25°C	34°			38°			
ϕ_m Phase margin at unity gain	$C_L = 20\text{ pF}$, See Figure 2	-55°C	39°			43°			
		125°C	25°			29°			

PARAMETER MEASUREMENT INFORMATION

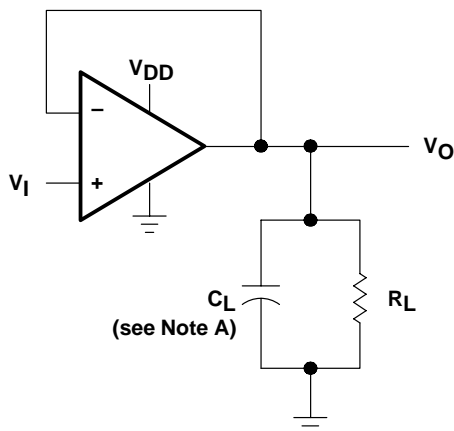

NOTE A: C_L includes fixture capacitance.

Figure 1. Slew-Rate Test Circuit

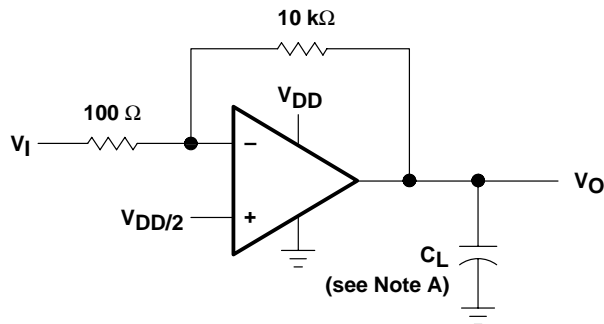

Figure 2. Unity-Gain Bandwidth and Phase-Margin Test Circuit

TYPICAL CHARACTERISTICS

Table of Graphs

		FIGURE
α_{VIO}	Temperature coefficient of input offset voltage	Distribution 3 – 6
I_{IB}	Input bias current	vs Free-air temperature 7
I_{IQ}	Input offset current	vs Free-air temperature 7
V_{IC}	Common-mode input voltage	vs Supply voltage 8
V_{OH}	High-level output voltage	vs High-level output current vs Supply voltage vs Free-air temperature 9, 10 11 12
V_{OL}	Low-level output voltage	vs Common-mode input voltage vs Differential input voltage vs Free-air temperature vs Low-level output current 13, 14 15 16 17, 18
A_{VD}	Large-signal differential voltage amplification	vs Supply voltage vs Free-air temperature vs Frequency 19 20 21, 22
V_{OM}	Maximum peak output voltage	vs Frequency 23
I_{DD}	Supply current	vs Supply voltage vs Free-air temperature 24 25
SR	Slew rate	vs Supply voltage vs Free-air temperature 26 27
	Normalized slew rate	vs Free-air temperature 28
V_n	Equivalent input noise voltage	vs Frequency 29
B_1	Unity-gain bandwidth	vs Supply voltage vs Free-air temperature 30 31
ϕ_m	Phase margin	vs Supply voltage vs Free-air temperature vs Capacitive load 32 33 34
	Phase shift	vs Frequency 21, 22

TYPICAL CHARACTERISTICS

DISTRIBUTION OF TLC1078
 INPUT OFFSET VOLTAGE
 TEMPERATURE COEFFICIENT

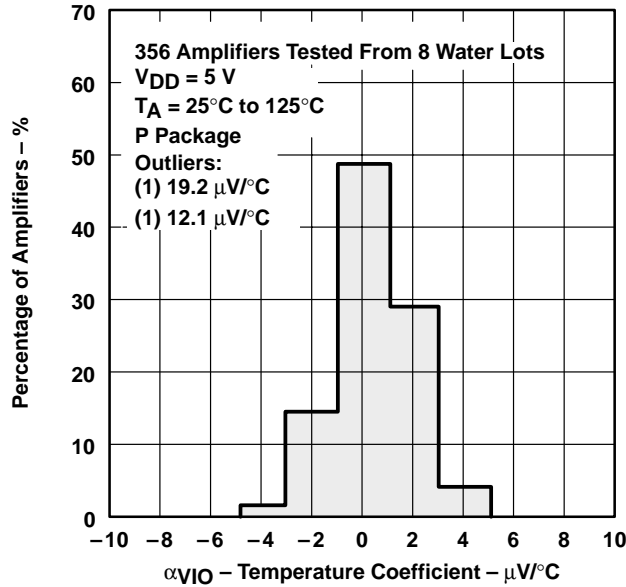

Figure 3

DISTRIBUTION OF TLC1078
 INPUT OFFSET VOLTAGE
 TEMPERATURE COEFFICIENT

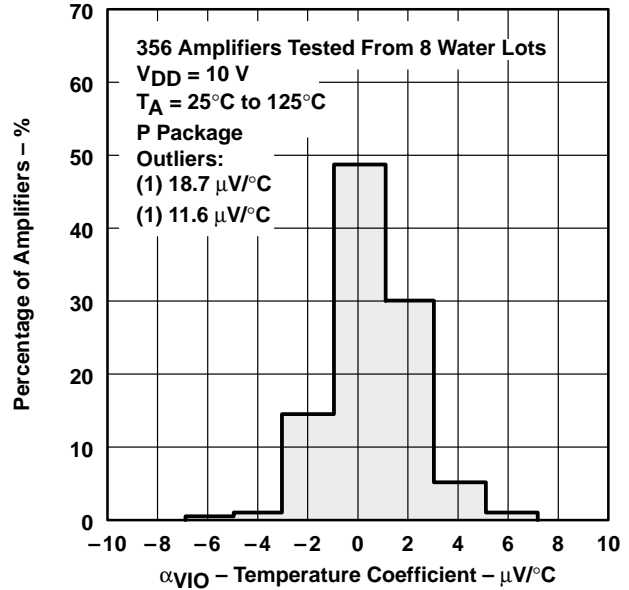

Figure 4

DISTRIBUTION OF TLC1079
 INPUT OFFSET VOLTAGE
 TEMPERATURE COEFFICIENT

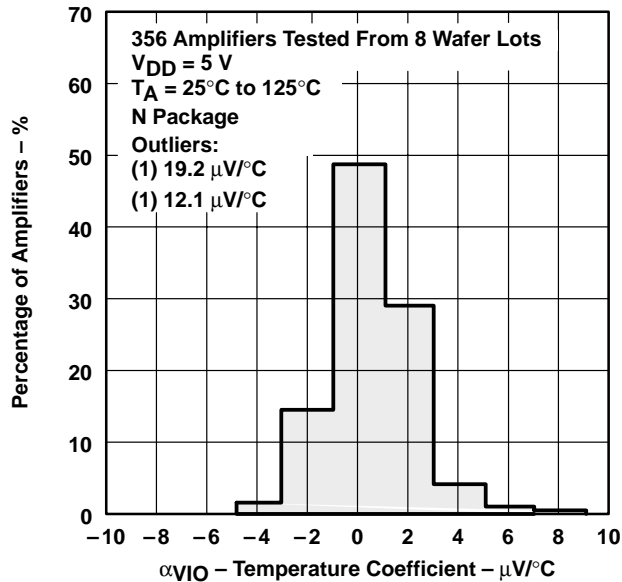

Figure 5

DISTRIBUTION OF TLC1079
 INPUT OFFSET VOLTAGE
 TEMPERATURE COEFFICIENT

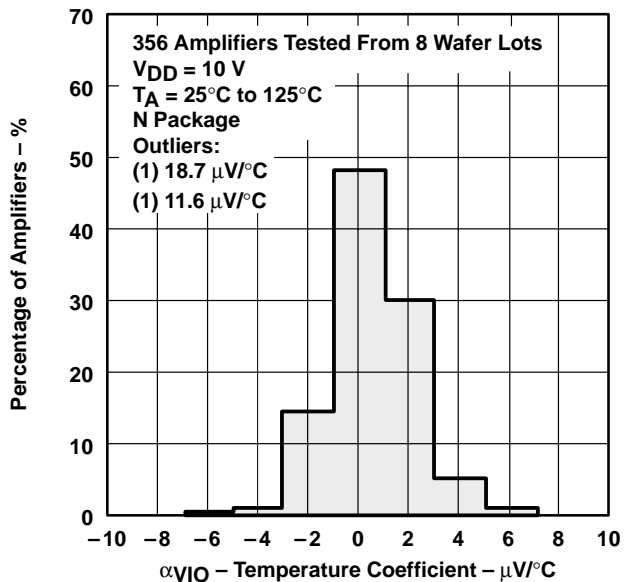
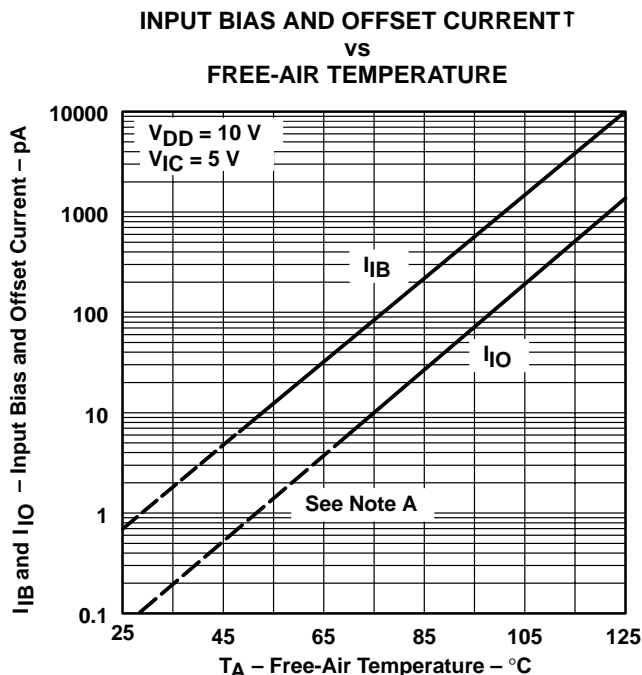

Figure 6

TYPICAL CHARACTERISTICS



NOTE A: The typical values of input bias current and input offset current below 5 pA were determined mathematically.

Figure 7

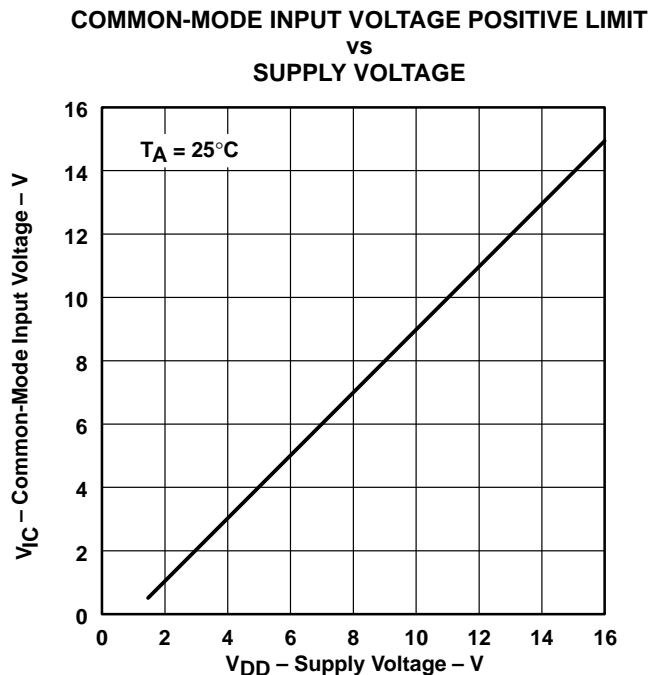

Figure 8

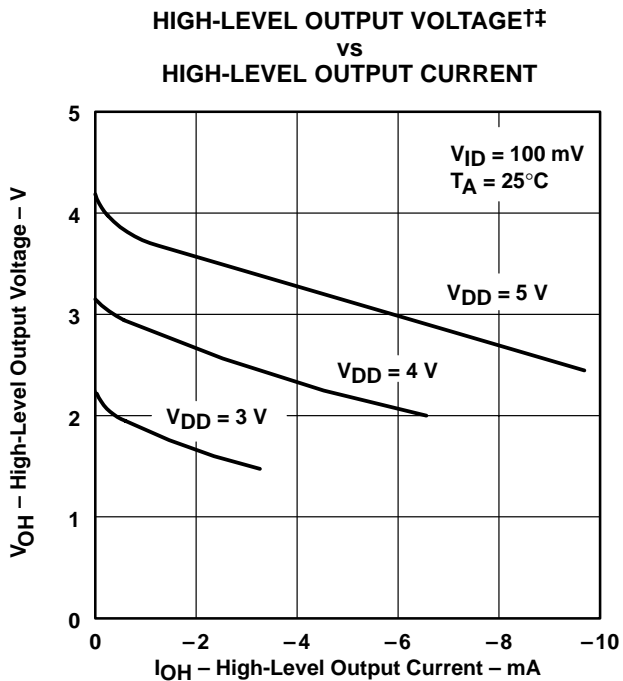

Figure 9

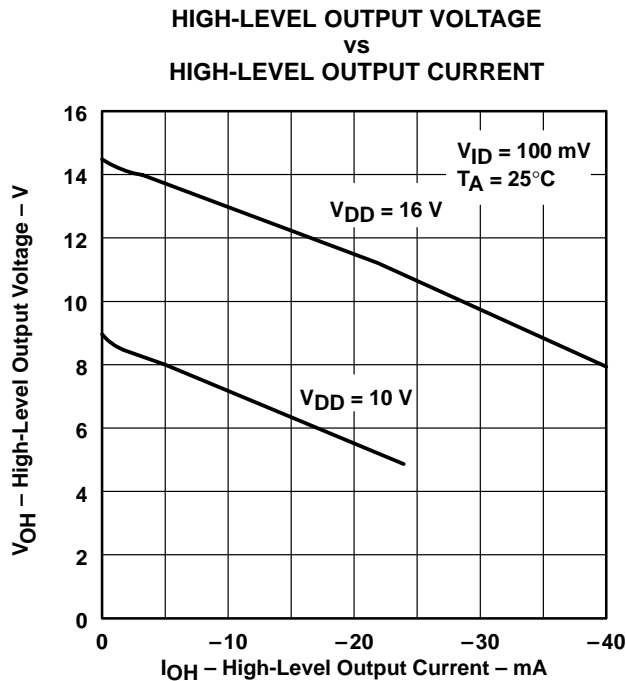

Figure 10

† Data at high and low temperatures are applicable only within the rated operating free-air temperature ranges of the various devices.
 † The $V_{DD} = 3\text{ V}$ curve does not apply to the TLC107xM.

TYPICAL CHARACTERISTICS

HIGH-LEVEL OUTPUT VOLTAGE
 vs
 SUPPLY VOLTAGE

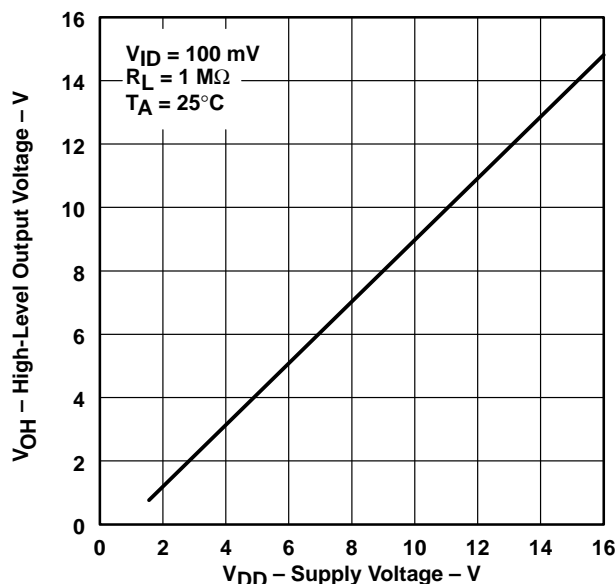

Figure 11

HIGH-LEVEL OUTPUT VOLTAGE†
 vs
 FREE-AIR TEMPERATURE

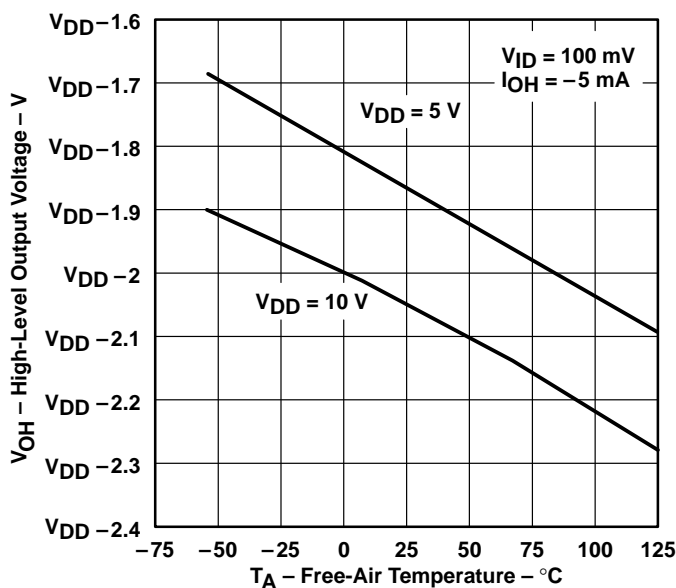

Figure 12

LOW-LEVEL OUTPUT VOLTAGE
 vs
 COMMON-MODE INPUT VOLTAGE

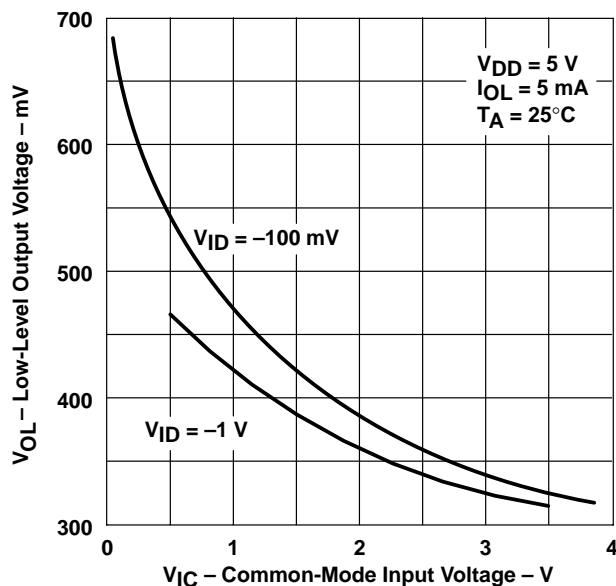

Figure 13

LOW-LEVEL OUTPUT VOLTAGE
 vs
 COMMON-MODE INPUT VOLTAGE

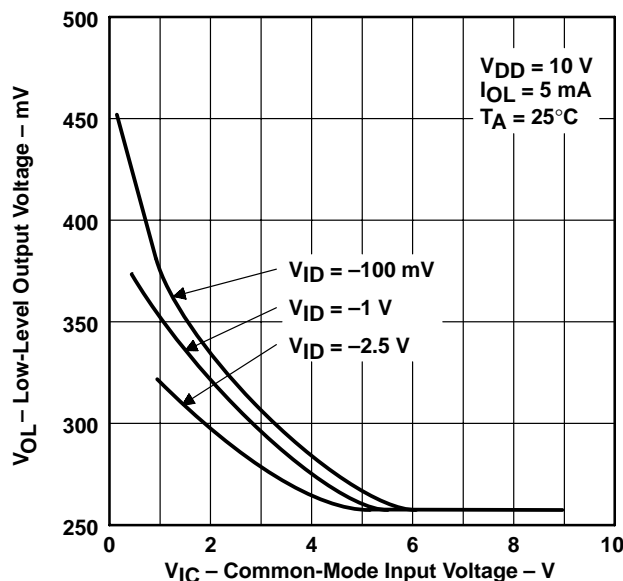

Figure 14

† Data at high and low temperatures are applicable only within the rated operating free-air temperature ranges of the various devices.

TYPICAL CHARACTERISTICS

LOW-LEVEL OUTPUT VOLTAGE
 vs
 DIFFERENTIAL INPUT VOLTAGE

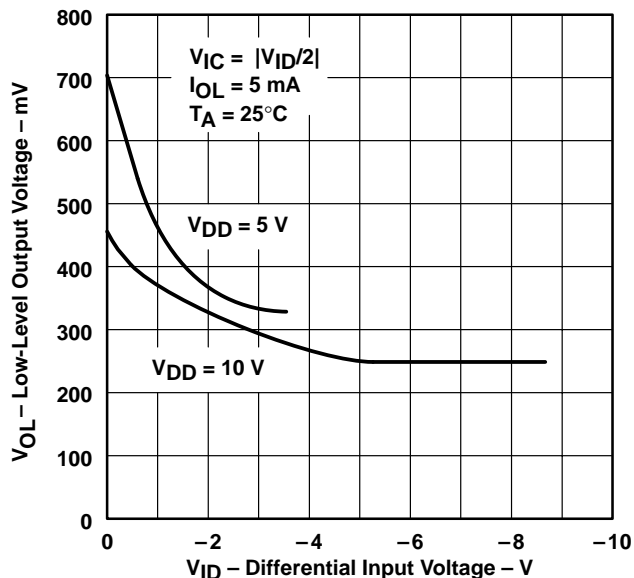

Figure 15

LOW-LEVEL OUTPUT VOLTAGE†
 vs
 FREE-AIR TEMPERATURE

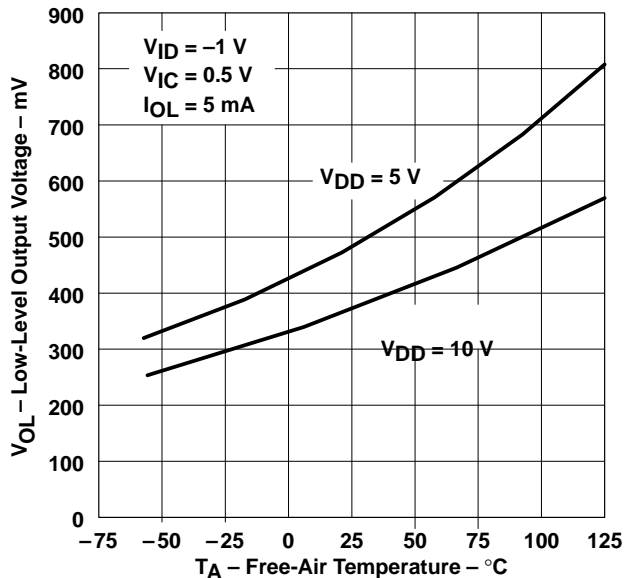

Figure 16

LOW-LEVEL OUTPUT VOLTAGE
 vs
 LOW-LEVEL OUTPUT CURRENT

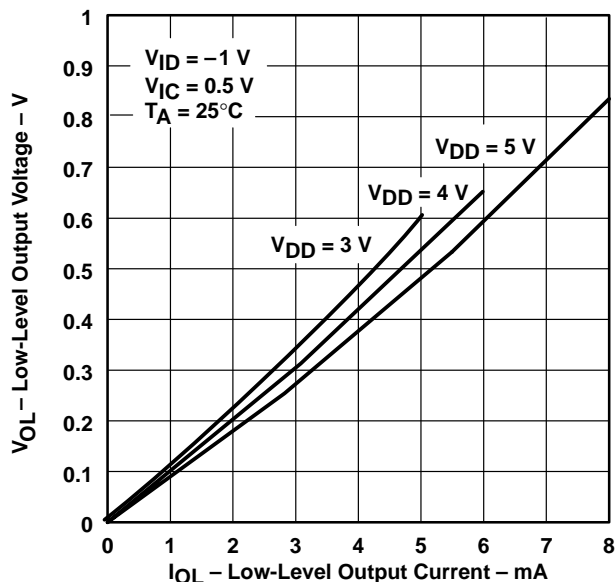

Figure 17

LOW-LEVEL OUTPUT VOLTAGE
 vs
 LOW-LEVEL OUTPUT CURRENT

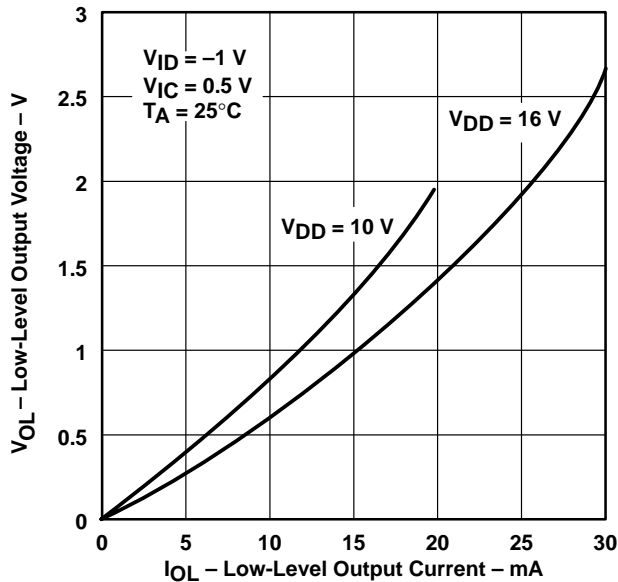

Figure 18

† Data at high and low temperatures are applicable only within the rated operating free-air temperature ranges of the various devices.

TYPICAL CHARACTERISTICS

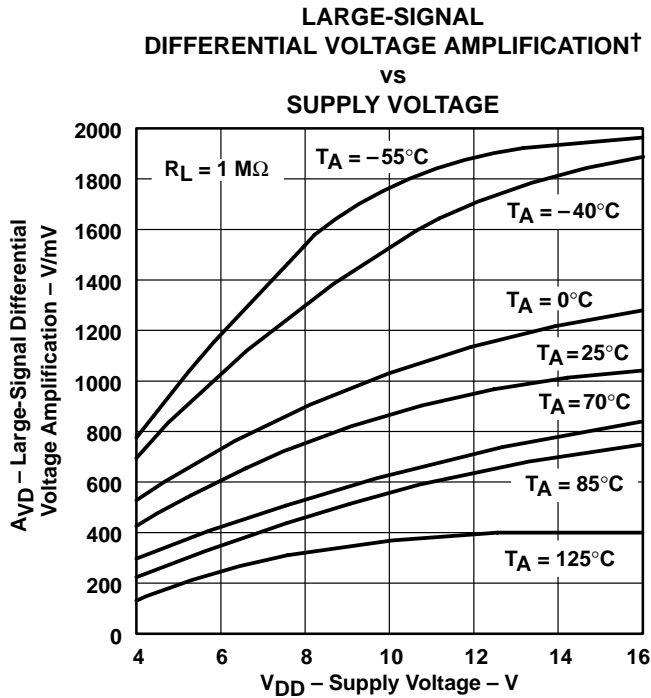

Figure 19

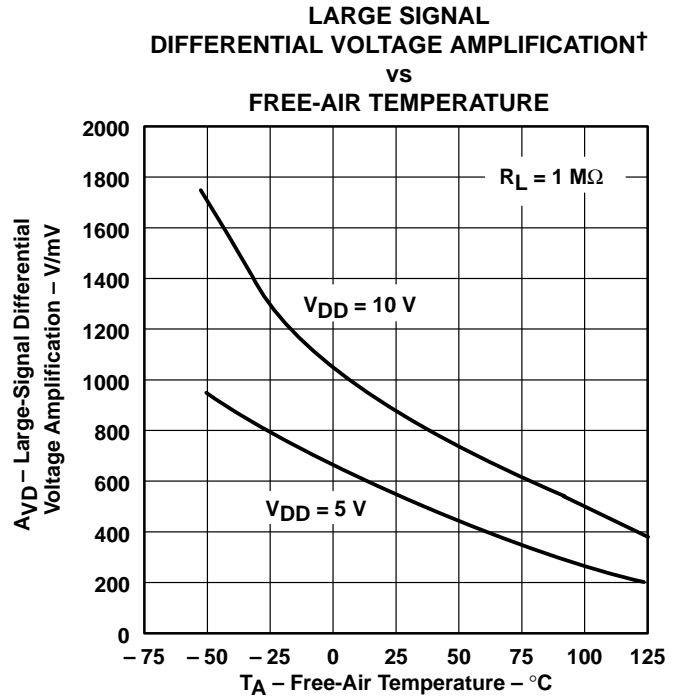

Figure 20

**LARGE-SIGNAL DIFFERENTIAL VOLTAGE
AMPLIFICATION AND PHASE SHIFT
vs
FREQUENCY**

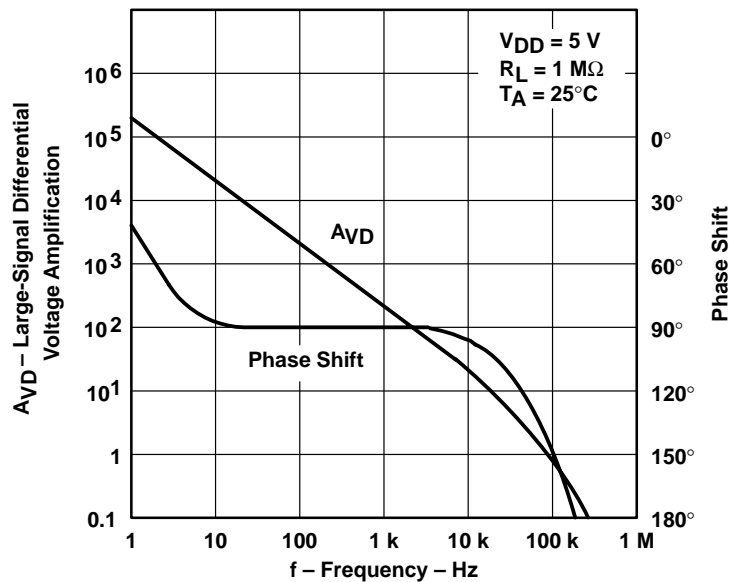

Figure 21

† Data at high and low temperatures are applicable only within the rated operating free-air temperature ranges of the various devices.

TYPICAL CHARACTERISTICS

LARGE-SIGNAL DIFFERENTIAL VOLTAGE
 AMPLIFICATION AND PHASE SHIFT
 VS
 FREQUENCY

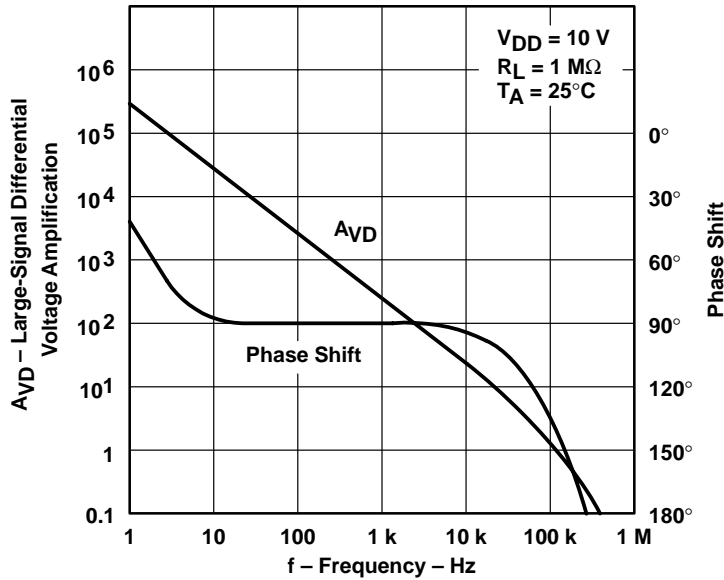

Figure 22

MAXIMUM PEAK OUTPUT VOLTAGE
 VS
 FREQUENCY

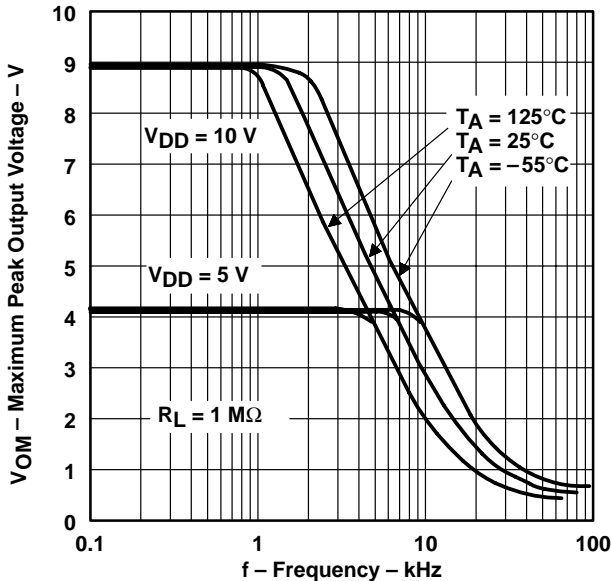

Figure 23

SUPPLY CURRENT†
 VS
 SUPPLY VOLTAGE

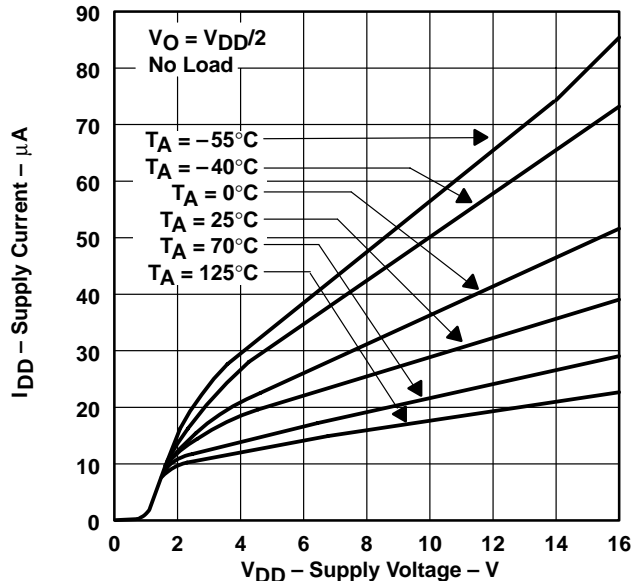
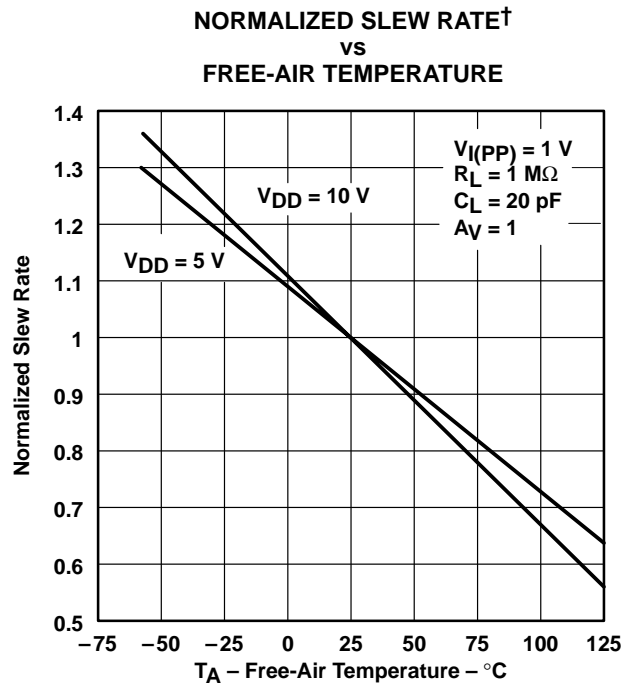
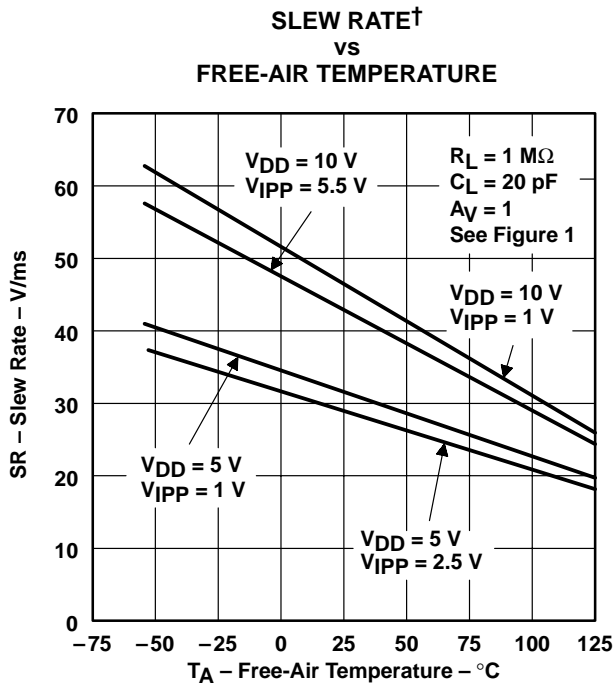
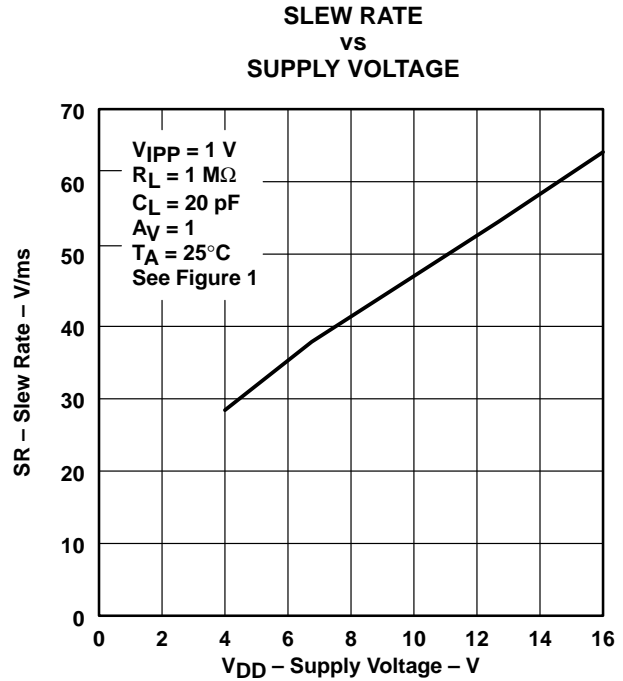
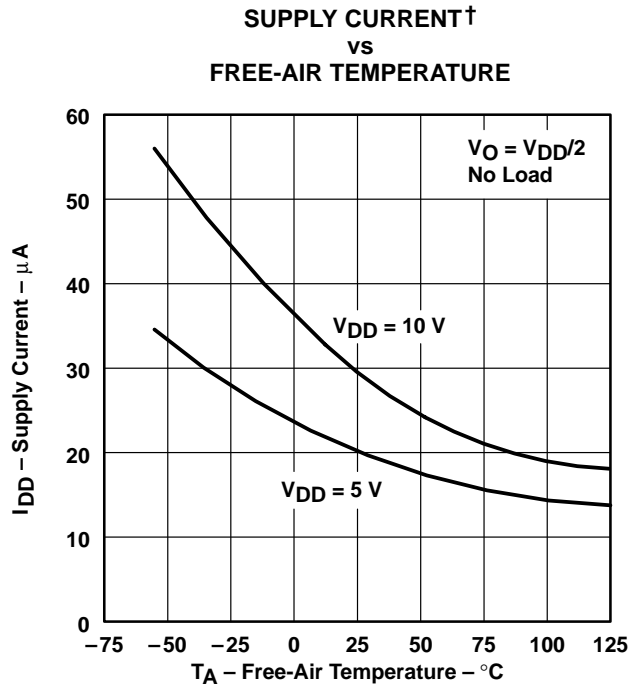

Figure 24

† Data at high and low temperatures are applicable only within the rated operating free-air temperature ranges of the various devices.

TYPICAL CHARACTERISTICS



† Data at high and low temperatures are applicable only within the rated operating free-air temperature ranges of the various devices.

TYPICAL CHARACTERISTICS

EQUIVALENT INPUT NOISE VOLTAGE
 VS
 FREQUENCY

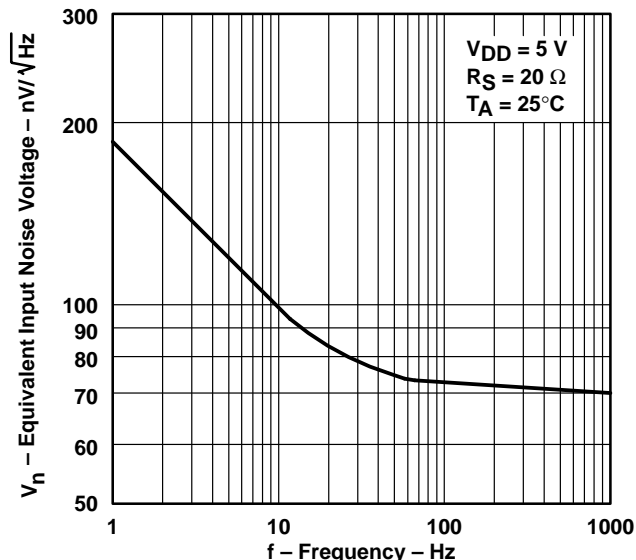

Figure 29

UNITY-GAIN BANDWIDTH
 VS
 SUPPLY VOLTAGE

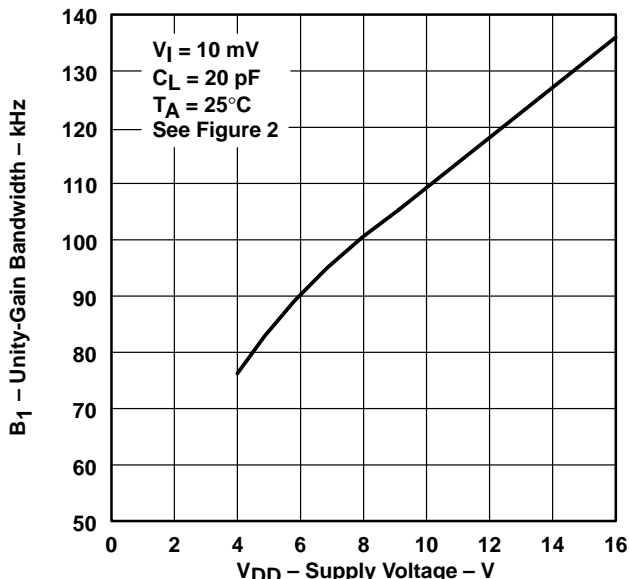

Figure 30

UNITY-GAIN BANDWIDTH†
 VS
 FREE-AIR TEMPERATURE

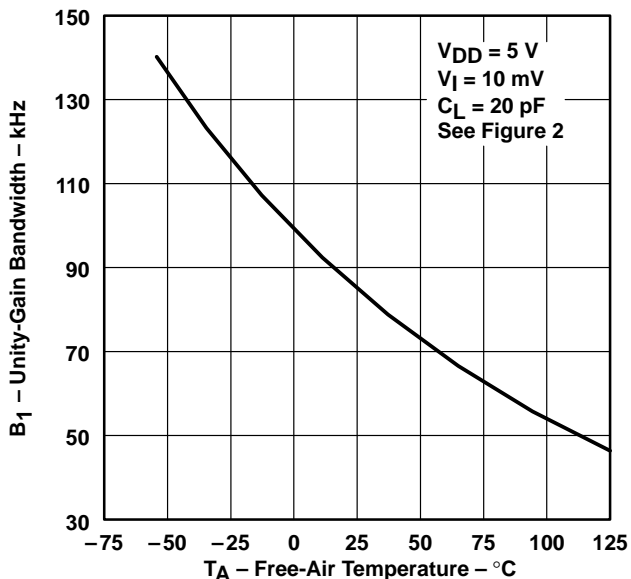

Figure 31

PHASE MARGIN
 VS
 SUPPLY VOLTAGE

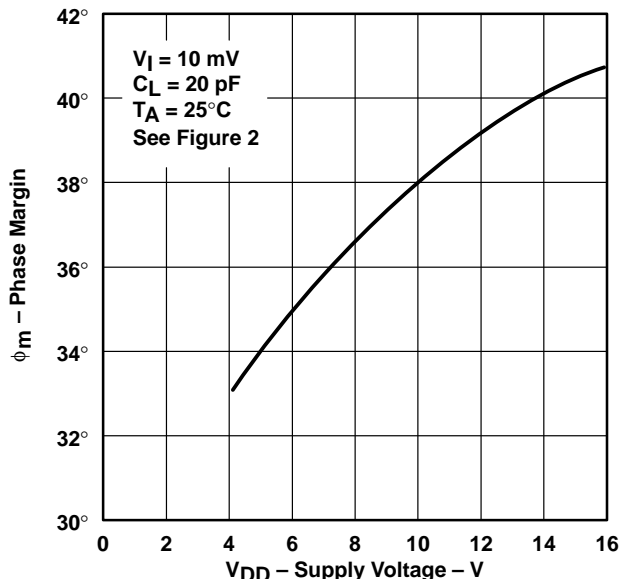

Figure 32

† Data at high and low temperatures are applicable only within the rated operating free-air temperature ranges of the various devices.

TYPICAL CHARACTERISTICS

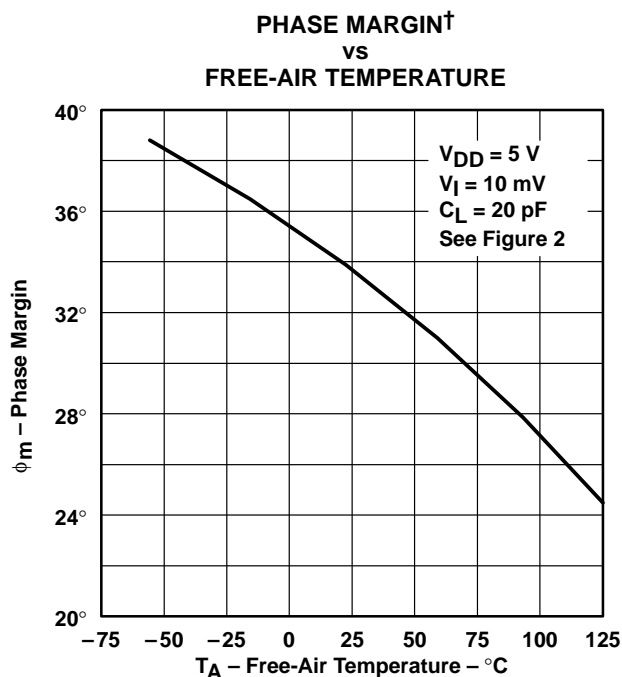

Figure 33

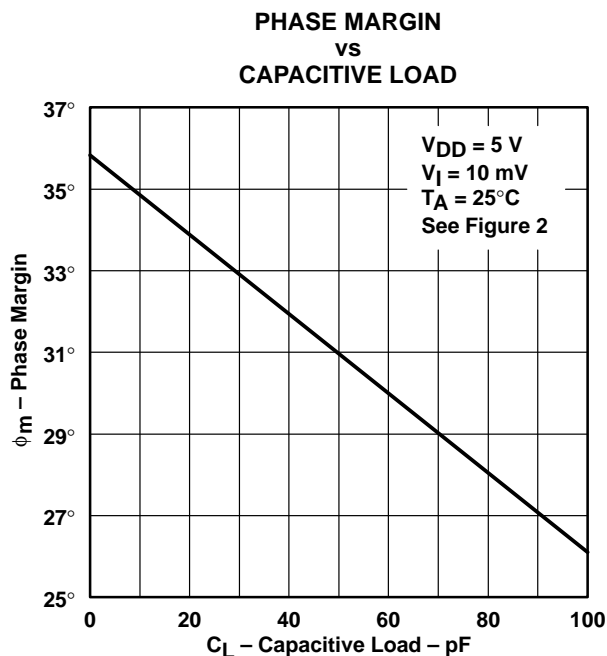

Figure 34

† Data at high and low temperatures are applicable only within the rated operating free-air temperature ranges of the various devices.

PACKAGING INFORMATION

Orderable Device	Status (1)	Package Type	Package Drawing	Pins	Package Qty	Eco Plan (2)	Lead finish/ Ball material (6)	MSL Peak Temp (3)	Op Temp (°C)	Device Marking (4/5)	Samples
TLC1078CD	ACTIVE	SOIC	D	8	75	RoHS & Green	NIPDAU	Level-1-260C-UNLIM	0 to 70	1078C	Samples
TLC1078CDR	ACTIVE	SOIC	D	8	2500	RoHS & Green	NIPDAU	Level-1-260C-UNLIM	0 to 70	1078C	Samples
TLC1078CP	ACTIVE	PDIP	P	8	50	RoHS & Green	NIPDAU	N / A for Pkg Type	0 to 70	TLC1078CP	Samples
TLC1078ID	ACTIVE	SOIC	D	8	75	RoHS & Green	NIPDAU	Level-1-260C-UNLIM	-40 to 85	1078I	Samples
TLC1078IDG4	LIFEBUY	SOIC	D	8	75	RoHS & Green	NIPDAU	Level-1-260C-UNLIM	-40 to 85	1078I	
TLC1078IDR	ACTIVE	SOIC	D	8	2500	RoHS & Green	NIPDAU	Level-1-260C-UNLIM	-40 to 85	1078I	Samples
TLC1078IP	ACTIVE	PDIP	P	8	50	RoHS & Green	NIPDAU	N / A for Pkg Type	-40 to 85	TLC1078IP	Samples
TLC1079CD	ACTIVE	SOIC	D	14	50	RoHS & Green	NIPDAU	Level-1-260C-UNLIM	0 to 70	TLC1079C	Samples
TLC1079CDR	ACTIVE	SOIC	D	14	2500	RoHS & Green	NIPDAU	Level-1-260C-UNLIM		TLC1079C	Samples
TLC1079CN	ACTIVE	PDIP	N	14	25	RoHS & Green	NIPDAU	N / A for Pkg Type		TLC1079CN	Samples
TLC1079ID	ACTIVE	SOIC	D	14	50	RoHS & Green	NIPDAU	Level-1-260C-UNLIM		TLC1079I	Samples
TLC1079IDR	ACTIVE	SOIC	D	14	2500	RoHS & Green	NIPDAU	Level-1-260C-UNLIM		TLC1079I	Samples
TLC1079IN	ACTIVE	PDIP	N	14	25	RoHS & Green	NIPDAU	N / A for Pkg Type		TLC1079IN	Samples

(1) The marketing status values are defined as follows:

ACTIVE: Product device recommended for new designs.

LIFEBUY: TI has announced that the device will be discontinued, and a lifetime-buy period is in effect.

NRND: Not recommended for new designs. Device is in production to support existing customers, but TI does not recommend using this part in a new design.

PREVIEW: Device has been announced but is not in production. Samples may or may not be available.

OBSOLETE: TI has discontinued the production of the device.

(2) **RoHS:** TI defines "RoHS" to mean semiconductor products that are compliant with the current EU RoHS requirements for all 10 RoHS substances, including the requirement that RoHS substance do not exceed 0.1% by weight in homogeneous materials. Where designed to be soldered at high temperatures, "RoHS" products are suitable for use in specified lead-free processes. TI may reference these types of products as "Pb-Free".

RoHS Exempt: TI defines "RoHS Exempt" to mean products that contain lead but are compliant with EU RoHS pursuant to a specific EU RoHS exemption.

Green: TI defines "Green" to mean the content of Chlorine (Cl) and Bromine (Br) based flame retardants meet JS709B low halogen requirements of <=1000ppm threshold. Antimony trioxide based flame retardants must also meet the <=1000ppm threshold requirement.

- (3) MSL, Peak Temp. - The Moisture Sensitivity Level rating according to the JEDEC industry standard classifications, and peak solder temperature.
- (4) There may be additional marking, which relates to the logo, the lot trace code information, or the environmental category on the device.
- (5) Multiple Device Markings will be inside parentheses. Only one Device Marking contained in parentheses and separated by a "~" will appear on a device. If a line is indented then it is a continuation of the previous line and the two combined represent the entire Device Marking for that device.
- (6) Lead finish/Ball material - Orderable Devices may have multiple material finish options. Finish options are separated by a vertical ruled line. Lead finish/Ball material values may wrap to two lines if the finish value exceeds the maximum column width.

Important Information and Disclaimer:The information provided on this page represents TI's knowledge and belief as of the date that it is provided. TI bases its knowledge and belief on information provided by third parties, and makes no representation or warranty as to the accuracy of such information. Efforts are underway to better integrate information from third parties. TI has taken and continues to take reasonable steps to provide representative and accurate information but may not have conducted destructive testing or chemical analysis on incoming materials and chemicals. TI and TI suppliers consider certain information to be proprietary, and thus CAS numbers and other limited information may not be available for release.

In no event shall TI's liability arising out of such information exceed the total purchase price of the TI part(s) at issue in this document sold by TI to Customer on an annual basis.

TAPE AND REEL INFORMATION

QUADRANT ASSIGNMENTS FOR PIN 1 ORIENTATION IN TAPE

*All dimensions are nominal

Device	Package Type	Package Drawing	Pins	SPQ	Reel Diameter (mm)	Reel Width W1 (mm)	A0 (mm)	B0 (mm)	K0 (mm)	P1 (mm)	W (mm)	Pin1 Quadrant
TLC1078CDR	SOIC	D	8	2500	330.0	12.4	6.4	5.2	2.1	8.0	12.0	Q1
TLC1078IDR	SOIC	D	8	2500	330.0	12.4	6.4	5.2	2.1	8.0	12.0	Q1
TLC1079CDR	SOIC	D	14	2500	330.0	16.4	6.5	9.0	2.1	8.0	16.0	Q1
TLC1079IDR	SOIC	D	14	2500	330.0	16.4	6.5	9.0	2.1	8.0	16.0	Q1

TAPE AND REEL BOX DIMENSIONS



*All dimensions are nominal

Device	Package Type	Package Drawing	Pins	SPQ	Length (mm)	Width (mm)	Height (mm)
TLC1078CDR	SOIC	D	8	2500	340.5	336.1	25.0
TLC1078IDR	SOIC	D	8	2500	340.5	336.1	25.0
TLC1079CDR	SOIC	D	14	2500	350.0	350.0	43.0
TLC1079IDR	SOIC	D	14	2500	350.0	350.0	43.0

TUBE

*All dimensions are nominal

Device	Package Name	Package Type	Pins	SPQ	L (mm)	W (mm)	T (μm)	B (mm)
TLC1078CD	D	SOIC	8	75	505.46	6.76	3810	4
TLC1078CD	D	SOIC	8	75	507	8	3940	4.32
TLC1078CP	P	PDIP	8	50	506	13.97	11230	4.32
TLC1078ID	D	SOIC	8	75	505.46	6.76	3810	4
TLC1078ID	D	SOIC	8	75	507	8	3940	4.32
TLC1078IDG4	D	SOIC	8	75	507	8	3940	4.32
TLC1078IDG4	D	SOIC	8	75	505.46	6.76	3810	4
TLC1078IP	P	PDIP	8	50	506	13.97	11230	4.32
TLC1079CD	D	SOIC	14	50	505.46	6.76	3810	4
TLC1079CN	N	PDIP	14	25	506	13.97	11230	4.32
TLC1079ID	D	SOIC	14	50	505.46	6.76	3810	4
TLC1079IN	N	PDIP	14	25	506	13.97	11230	4.32

D (R-PDSO-G14)

PLASTIC SMALL OUTLINE



- NOTES:
- A. All linear dimensions are in inches (millimeters).
 - B. This drawing is subject to change without notice.
 -  Body length does not include mold flash, protrusions, or gate burrs. Mold flash, protrusions, or gate burrs shall not exceed 0.006 (0,15) each side.
 -  Body width does not include interlead flash. Interlead flash shall not exceed 0.017 (0,43) each side.
 - E. Reference JEDEC MS-012 variation AB.



D0008A

PACKAGE OUTLINE

SOIC - 1.75 mm max height

SMALL OUTLINE INTEGRATED CIRCUIT



4214825/C 02/2019

NOTES:

1. Linear dimensions are in inches [millimeters]. Dimensions in parenthesis are for reference only. Controlling dimensions are in inches. Dimensioning and tolerancing per ASME Y14.5M.
2. This drawing is subject to change without notice.
3. This dimension does not include mold flash, protrusions, or gate burrs. Mold flash, protrusions, or gate burrs shall not exceed $.006$ [0.15] per side.
4. This dimension does not include interlead flash.
5. Reference JEDEC registration MS-012, variation AA.

EXAMPLE BOARD LAYOUT

D0008A

SOIC - 1.75 mm max height

SMALL OUTLINE INTEGRATED CIRCUIT



LAND PATTERN EXAMPLE
 EXPOSED METAL SHOWN
 SCALE:8X



SOLDER MASK DETAILS

4214825/C 02/2019

NOTES: (continued)

- 6. Publication IPC-7351 may have alternate designs.
- 7. Solder mask tolerances between and around signal pads can vary based on board fabrication site.

EXAMPLE STENCIL DESIGN

D0008A

SOIC - 1.75 mm max height

SMALL OUTLINE INTEGRATED CIRCUIT



SOLDER PASTE EXAMPLE
BASED ON .005 INCH [0.125 MM] THICK STENCIL
SCALE:8X

4214825/C 02/2019

NOTES: (continued)

8. Laser cutting apertures with trapezoidal walls and rounded corners may offer better paste release. IPC-7525 may have alternate design recommendations.
9. Board assembly site may have different recommendations for stencil design.

P (R-PDIP-T8)

PLASTIC DUAL-IN-LINE PACKAGE



- NOTES:
- A. All linear dimensions are in inches (millimeters).
 - B. This drawing is subject to change without notice.
 - C. Falls within JEDEC MS-001 variation BA.

N (R-PDIP-T**)

PLASTIC DUAL-IN-LINE PACKAGE

16 PINS SHOWN



4040049/E 12/2002

- NOTES:
- A. All linear dimensions are in inches (millimeters).
 - B. This drawing is subject to change without notice.
 - (C) Falls within JEDEC MS-001, except 18 and 20 pin minimum body length (Dim A).
 - (D) The 20 pin end lead shoulder width is a vendor option, either half or full width.

IMPORTANT NOTICE AND DISCLAIMER

TI PROVIDES TECHNICAL AND RELIABILITY DATA (INCLUDING DATA SHEETS), DESIGN RESOURCES (INCLUDING REFERENCE DESIGNS), APPLICATION OR OTHER DESIGN ADVICE, WEB TOOLS, SAFETY INFORMATION, AND OTHER RESOURCES "AS IS" AND WITH ALL FAULTS, AND DISCLAIMS ALL WARRANTIES, EXPRESS AND IMPLIED, INCLUDING WITHOUT LIMITATION ANY IMPLIED WARRANTIES OF MERCHANTABILITY, FITNESS FOR A PARTICULAR PURPOSE OR NON-INFRINGEMENT OF THIRD PARTY INTELLECTUAL PROPERTY RIGHTS.

These resources are intended for skilled developers designing with TI products. You are solely responsible for (1) selecting the appropriate TI products for your application, (2) designing, validating and testing your application, and (3) ensuring your application meets applicable standards, and any other safety, security, regulatory or other requirements.

These resources are subject to change without notice. TI grants you permission to use these resources only for development of an application that uses the TI products described in the resource. Other reproduction and display of these resources is prohibited. No license is granted to any other TI intellectual property right or to any third party intellectual property right. TI disclaims responsibility for, and you will fully indemnify TI and its representatives against, any claims, damages, costs, losses, and liabilities arising out of your use of these resources.

TI's products are provided subject to [TI's Terms of Sale](#) or other applicable terms available either on [ti.com](https://www.ti.com) or provided in conjunction with such TI products. TI's provision of these resources does not expand or otherwise alter TI's applicable warranties or warranty disclaimers for TI products.

TI objects to and rejects any additional or different terms you may have proposed.

Mailing Address: Texas Instruments, Post Office Box 655303, Dallas, Texas 75265
Copyright © 2023, Texas Instruments Incorporated