

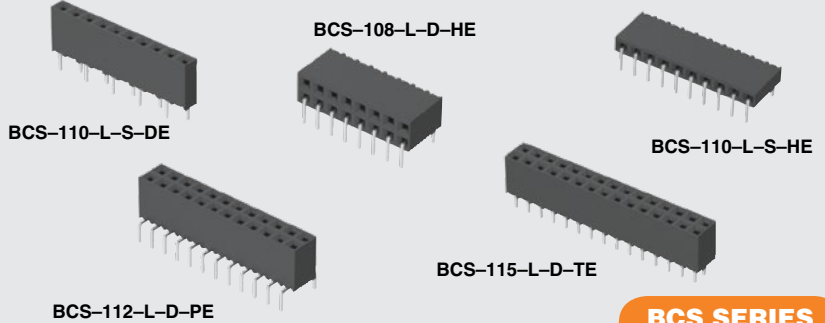

(2.54 mm) .100"



BCS SERIES

TIGER CLAW™ PASS-THROUGH SOCKET

Mates with:

TSW, MTSW, HTSW, HMTSW, TSS, ZSS, DW, EW, ZW, HW, TSM, MTLW, PHT

SPECIFICATIONS

For complete specifications see www.samtec.com?BCS

Insulator Material: Black Liquid Crystal Polymer

Contact Material: Phosphor Bronze

Plating:

Au or Sn over

50 μm (1.27 μm) Ni

Current Rating (BCS/TSW):

4.6 A per pin

(2 pins powered)

Voltage Rating:

475 VAC

(-TE/-DE/-PE mated with TSM)

450 VAC

(-HE mated with TSW)

Operating Temp Range:

-55 °C to +125 °C

Insertion Depth:

(4.34 mm) .171" to (7.24 mm)

.285" from top, (5.64 mm)

.222" plus board thickness

minimum from bottom.

-HE is (4.34 mm) .171"

to (6.35 mm) .250"

RoHS Compliant:

Yes

Lead-Free Solderable:

Yes

RECOGNITIONS

For complete scope of recognitions see www.samtec.com/quality



ALSO AVAILABLE (MOQ Required)

- Other platings

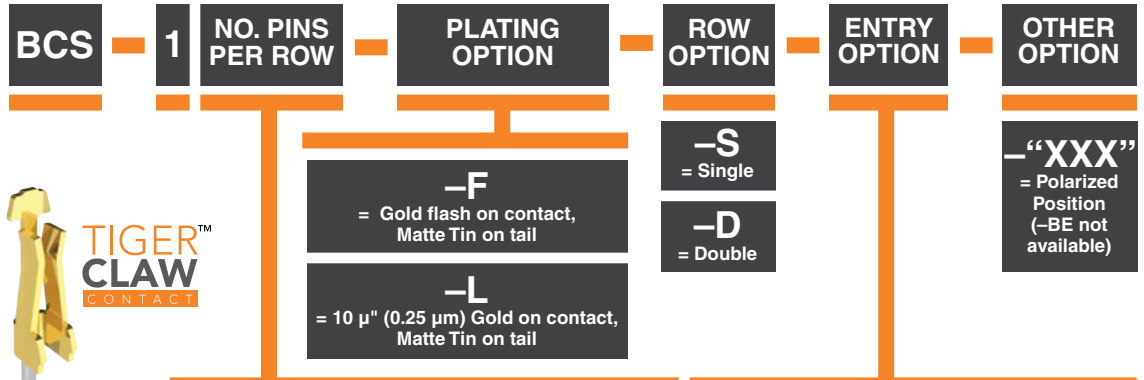

01 thru 50

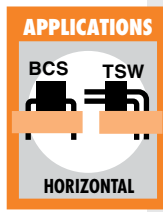
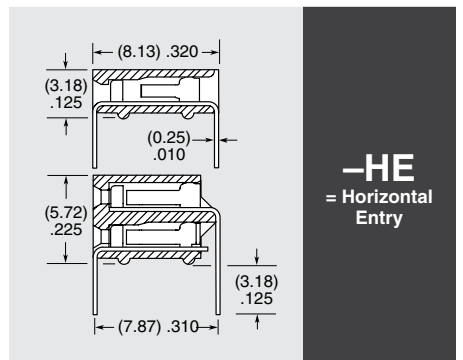
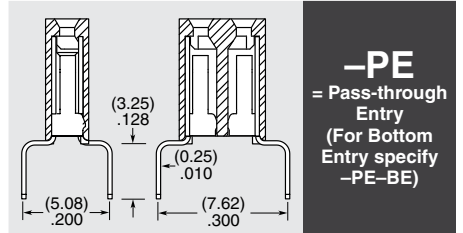
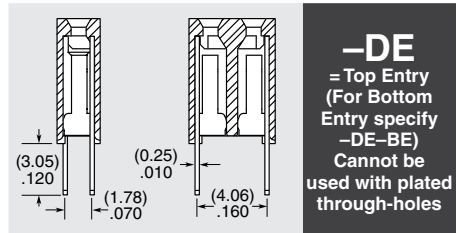
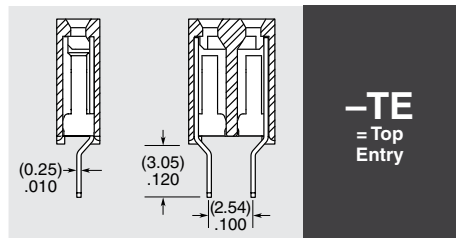
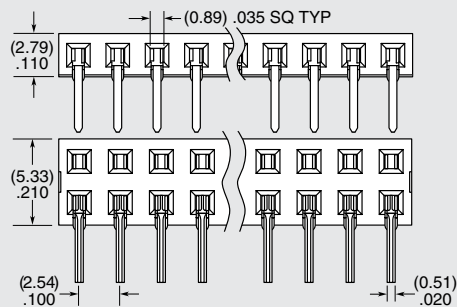
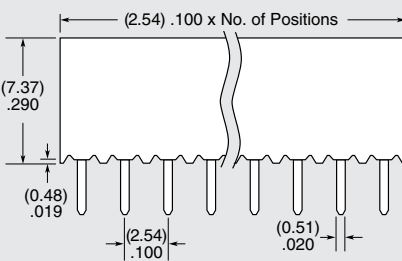
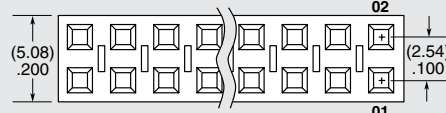
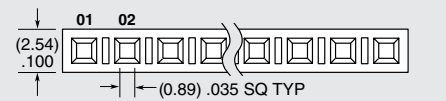

Note: Some lengths, styles and options are non-standard, non-returnable.

Due to technical progress, all designs, specifications and components are subject to change without notice.

WWW.SAMTEC.COM

All parts within this catalog are built to Samtec's specifications.

Customer specific requirements must be approved by Samtec and identified in a Samtec customer-specific drawing to apply.