

IRL3502SPbF

HEXFET® Power MOSFET

- Advanced Process Technology
- Surface Mount
- Optimized for 4.5V-7.0V Gate Drive
- Ideal for CPU Core DC-DC Converters
- Fast Switching
- Lead-Free

Description

These HEXFET Power MOSFETs were designed specifically to meet the demands of CPU core DC-DC converters in the PC environment. Advanced processing techniques combined with an optimized gate oxide design results in a die sized specifically to offer maximum efficiency at minimum cost.

The D²Pak is a surface mount power package capable of accommodating die sizes up to HEX-4. It provides the highest power capability and the lowest possible on-resistance in any existing surface mount package. The D²Pak is suitable for high current applications because of its low internal connection resistance and can dissipate up to 2.0W in a typical surface mount application.

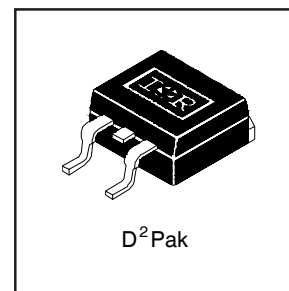
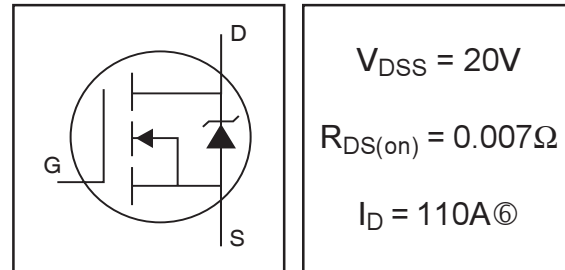

Absolute Maximum Ratings

	Parameter	Max.	Units
$I_D @ T_C = 25^\circ\text{C}$	Continuous Drain Current, $V_{GS} @ 4.5\text{V}$ Ⓞ	110Ⓞ	A
$I_D @ T_C = 100^\circ\text{C}$	Continuous Drain Current, $V_{GS} @ 4.5\text{V}$ Ⓞ	67	
I_{DM}	Pulsed Drain Current ① ⑤	420	
$P_D @ T_C = 25^\circ\text{C}$	Power Dissipation	140	W
	Linear Derating Factor	1.1	W/°C
V_{GS}	Gate-to-Source Voltage	± 10	V
V_{GSM}	Gate-to-Source Voltage (Start Up Transient, $t_p = 100\mu\text{s}$)	14	V
E_{AS}	Single Pulse Avalanche Energy② ⑤	390	mJ
I_{AR}	Avalanche Current①	64	A
E_{AR}	Repetitive Avalanche Energy①	14	mJ
dv/dt	Peak Diode Recovery dv/dt ③ ⑤	5.0	V/ns
T_J	Operating Junction and Storage Temperature Range	-55 to + 150	°C
T_{STG}			
	Soldering Temperature, for 10 seconds	300 (1.6mm from case)	

Thermal Resistance

	Parameter	Typ.	Max.	Units
$R_{\theta JC}$	Junction-to-Case	---	0.89	°C/W
$R_{\theta JA}$	Junction-to-Ambient (PCB Mounted, steady-state)**	---	40	

IRL3502SPbF

International
IR Rectifier

Electrical Characteristics @ T_J = 25°C (unless otherwise specified)

	Parameter	Min.	Typ.	Max.	Units	Conditions
V _{(BR)DSS}	Drain-to-Source Breakdown Voltage	20	—	—	V	V _{GS} = 0V, I _D = 250μA
ΔV _{(BR)DSS} /ΔT _J	Breakdown Voltage Temp. Coefficient	—	0.019	—	V/°C	Reference to 25°C, I _D = 1.0mA ^⑤
R _{DS(on)}	Static Drain-to-Source On-Resistance	—	—	0.008	Ω	V _{GS} = 4.5V, I _D = 64A ^④
		—	—	0.007		V _{GS} = 7.0V, I _D = 64A ^④
V _{GS(th)}	Gate Threshold Voltage	0.70	—	—	V	V _{DS} = V _{GS} , I _D = 250μA
g _{fs}	Forward Transconductance	77	—	—	S	V _{DS} = 10V, I _D = 64A ^⑤
I _{DSS}	Drain-to-Source Leakage Current	—	—	25	μA	V _{DS} = 20V, V _{GS} = 0V
		—	—	250		V _{DS} = 10V, V _{GS} = 0V, T _J = 150°C
I _{GSS}	Gate-to-Source Forward Leakage	—	—	100	nA	V _{GS} = 10V
	Gate-to-Source Reverse Leakage	—	—	-100		V _{GS} = -10V
Q _g	Total Gate Charge	—	—	110	nC	I _D = 64A
Q _{gs}	Gate-to-Source Charge	—	—	27		V _{DS} = 16V
Q _{gd}	Gate-to-Drain ("Miller") Charge	—	—	39		V _{GS} = 4.5V, See Fig. 6 ^{④⑤}
t _{d(on)}	Turn-On Delay Time	—	10	—	ns	V _{DD} = 10V
t _r	Rise Time	—	140	—		I _D = 64A
t _{d(off)}	Turn-Off Delay Time	—	96	—		R _G = 3.8Ω, V _{GS} = 4.5V
t _f	Fall Time	—	130	—		R _D = 0.15Ω, ^{④⑤}
L _S	Internal Source Inductance	—	7.5	—	nH	Between lead, and center of die contact
C _{iss}	Input Capacitance	—	4700	—	pF	V _{GS} = 0V
C _{oss}	Output Capacitance	—	1900	—		V _{DS} = 15V
C _{rss}	Reverse Transfer Capacitance	—	640	—		f = 1.0MHz, See Fig. 5 ^⑤

Source-Drain Ratings and Characteristics

	Parameter	Min.	Typ.	Max.	Units	Conditions
I _S	Continuous Source Current (Body Diode)	—	—	110 ^⑥	A	MOSFET symbol showing the integral reverse p-n junction diode.
I _{SM}	Pulsed Source Current (Body Diode) ^{①⑤}	—	—	420		
V _{SD}	Diode Forward Voltage	—	—	1.3	V	T _J = 25°C, I _S = 64A, V _{GS} = 0V ^④
t _{rr}	Reverse Recovery Time	—	87	130	ns	T _J = 25°C, I _F = 64A
Q _{rr}	Reverse Recovery Charge	—	200	310	nC	di/dt = 100A/μs ^{④⑤}
t _{on}	Forward Turn-On Time	Intrinsic turn-on time is negligible (turn-on is dominated by L _S +L _D)				

Notes:

- ① Repetitive rating; pulse width limited by max. junction temperature.
- ② Starting T_J = 25°C, L = 190μH
R_G = 25Ω, I_{AS} = 64A.
- ③ I_{SD} ≤ 64A, di/dt ≤ 86A/μs, V_{DD} ≤ V_{(BR)DSS},
T_J ≤ 150°C
- ④ Pulse width ≤ 300μs; duty cycle ≤ 2%.
- ⑤ Uses IRL3502 data and test conditions
- ⑥ Calculated continuous current based on maximum allowable junction temperature; for recommended current-handling of the package refer to Design Tip # 93-4

** When mounted on FR-4 board using minimum recommended footprint.
For recommended footprint and soldering techniques refer to application note #AN-994.

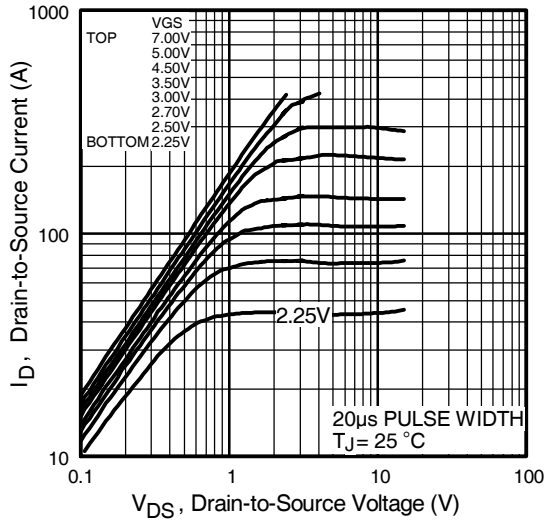

Fig 1. Typical Output Characteristics

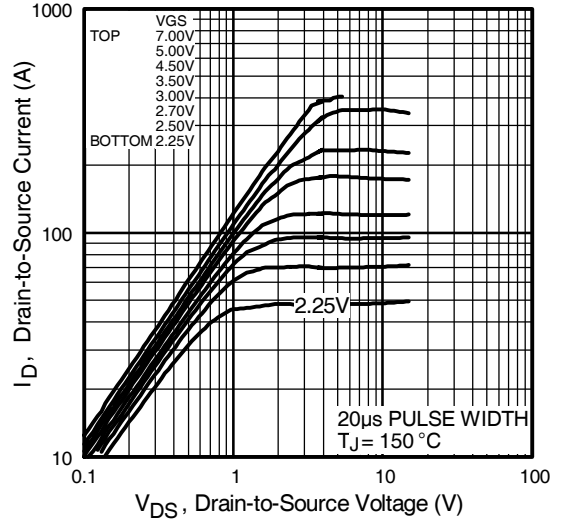

Fig 2. Typical Output Characteristics

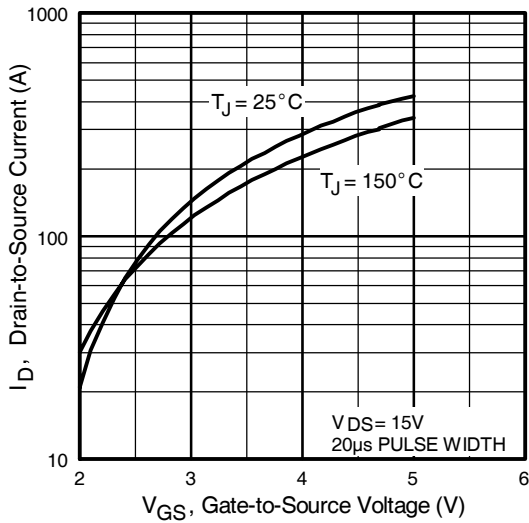

Fig 3. Typical Transfer Characteristics

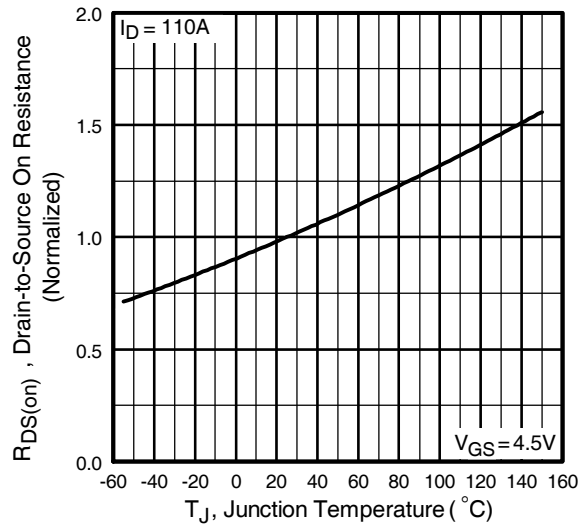

Fig 4. Normalized On-Resistance Vs. Temperature

IRL3502SPbF

International
IR Rectifier

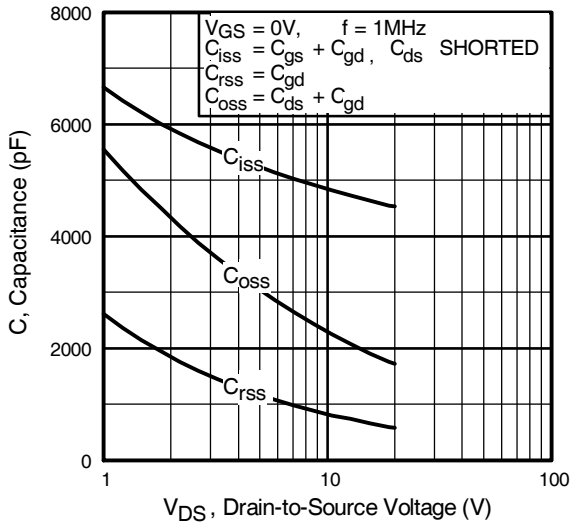

Fig 5. Typical Capacitance Vs. Drain-to-Source Voltage

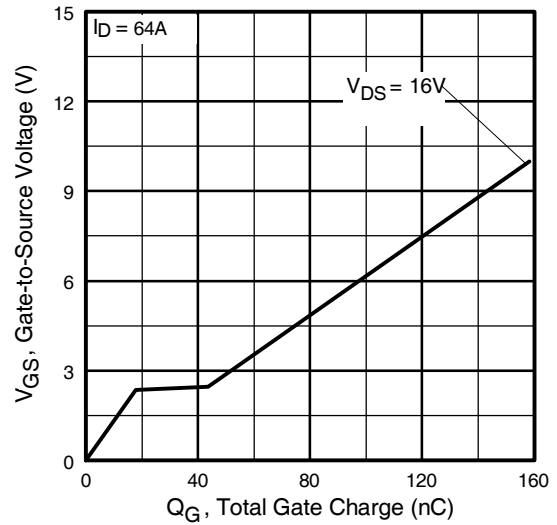

Fig 6. Typical Gate Charge Vs. Gate-to-Source Voltage

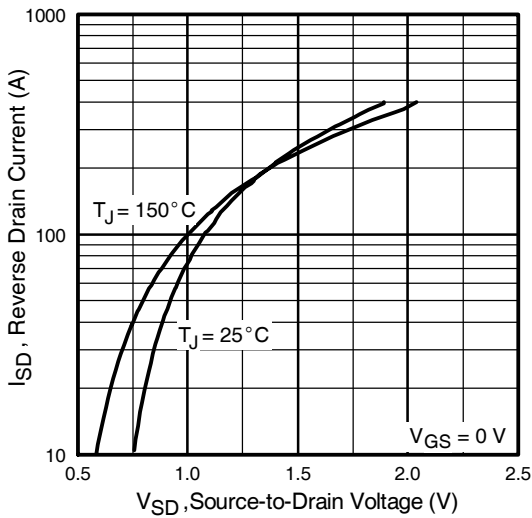

Fig 7. Typical Source-Drain Diode Forward Voltage

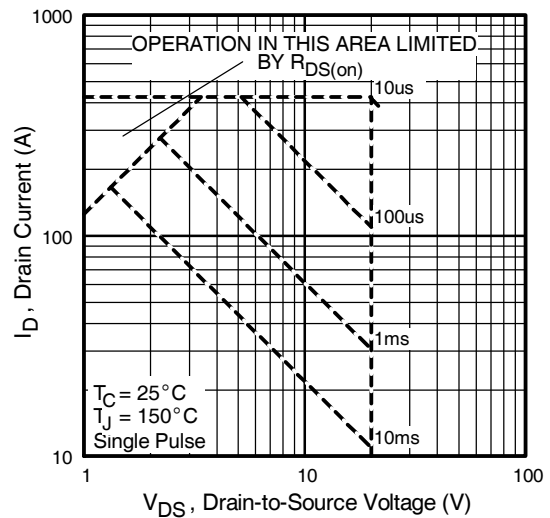

Fig 8. Maximum Safe Operating Area

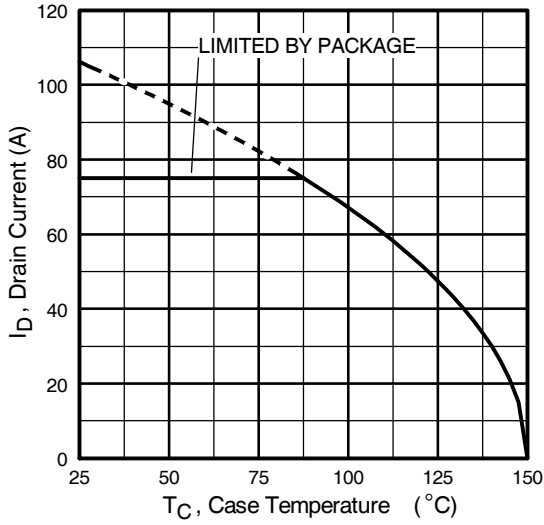

Fig 9. Maximum Drain Current Vs. Case Temperature

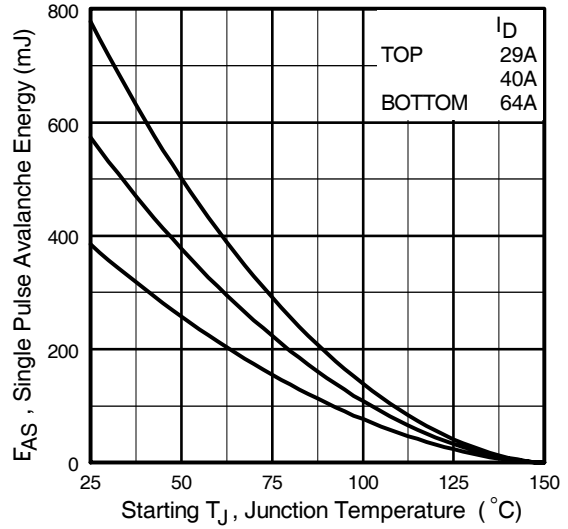

Fig 10. Maximum Avalanche Energy Vs. Drain Current

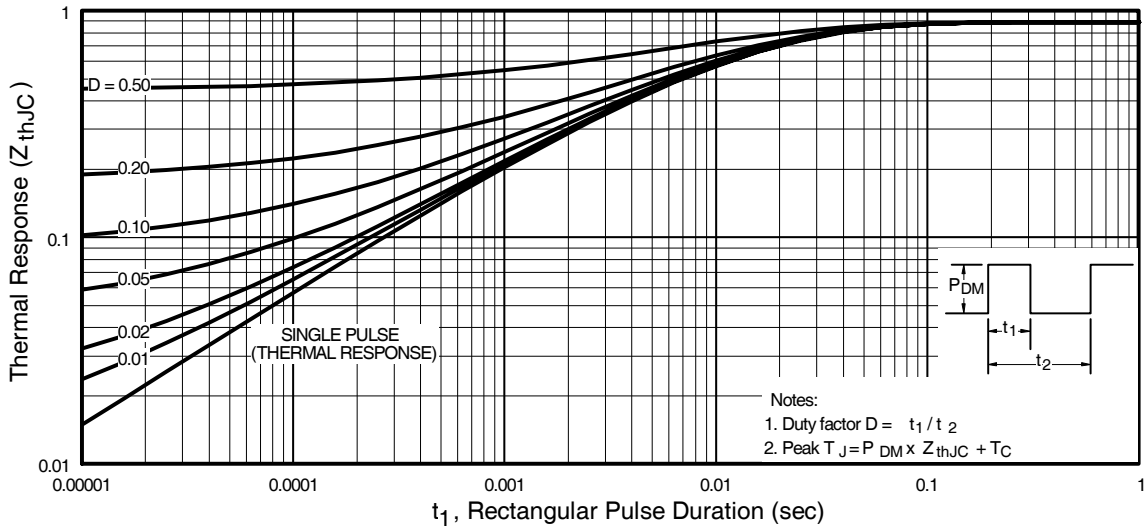

Fig 11. Maximum Effective Transient Thermal Impedance, Junction-to-Case

IRL3502SPbF

International
IR Rectifier

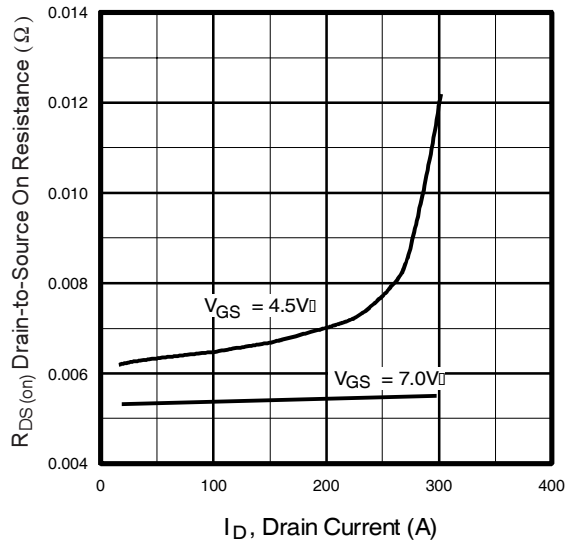

Fig 12. On-Resistance Vs. Drain Current

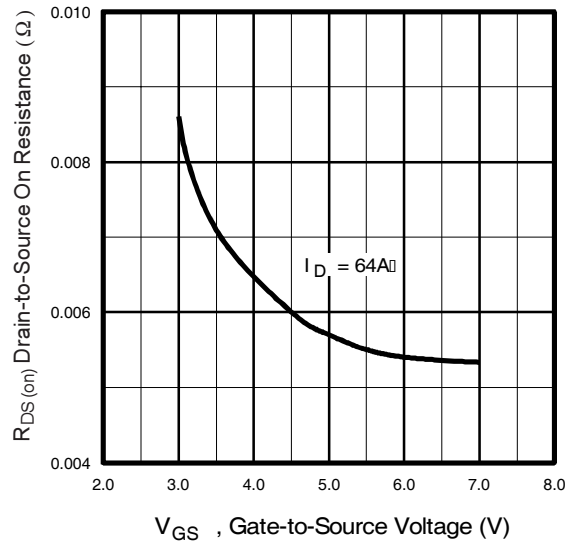
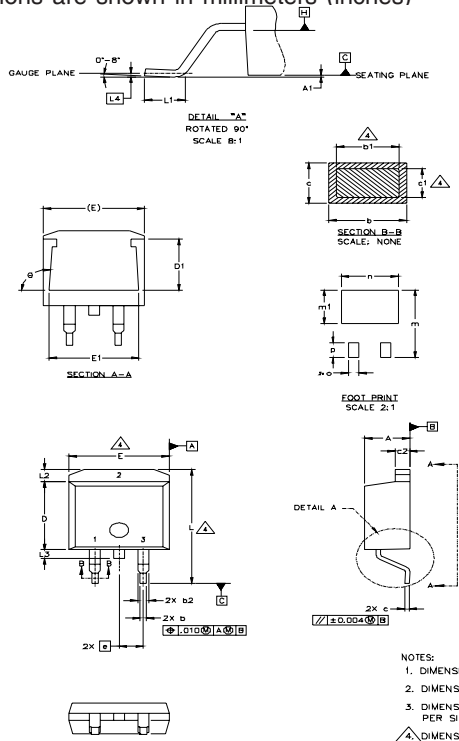

Fig 13. On-Resistance Vs. Gate Voltage

D²Pak Package Outline

Dimensions are shown in millimeters (inches)



SYMBOL	DIMENSIONS				NOTES
	MILLIMETERS		INCHES		
	MIN.	MAX.	MIN.	MAX.	
A	4.06	4.83	.160	.190	4
A1		0.127		.005	
b	0.51	0.99	.020	.039	
b1	0.51	0.89	.020	.035	4
b2	1.14	1.40	.045	.055	
c	0.43	0.63	.017	.025	
c1	0.38	0.74	.015	.029	3
c2	1.14	1.40	.045	.055	
D	8.51	9.65	.335	.380	
D1	5.33		.210		3
E	9.65	10.67	.380	.420	
E1	6.22		.245		
e	2.54 BSC		.100 BSC		
L	14.61	15.88	.575	.625	
L1	1.78	2.79	.070	.110	
L2		1.65		.065	
L3	1.27	1.78	.050	.070	
L4	0.25 BSC		.010 BSC		
m	17.78		.700		
m1	8.89		.350		
n	11.43		.450		
o	2.08		.082		
p	3.81		.150		
θ	90°	9.3°	90°	9.3°	

LEAD ASSIGNMENTS

- | | | |
|---------------|----------------------|---------------|
| HEXFET | IGBTs, CoPACK | DIODES |
| 1.- GATE | 1.- GATE | 1.- ANODE * |
| 2.- DRAIN | 2.- COLLECTOR | 2.- CATHODE |
| 3.- SOURCE | 3.- EMITTER | 3.- ANODE |
- * PART DEPENDENT.

- NOTES:**
1. DIMENSIONING AND TOLERANCING PER ASME Y14.5M-1994
 2. DIMENSIONS ARE SHOWN IN MILLIMETERS [INCHES].
 3. DIMENSION D & E DO NOT INCLUDE MOLD FLASH. MOLD FLASH SHALL NOT EXCEED 0.127 [005"] PER SIDE. THESE DIMENSIONS ARE MEASURED AT THE OUTMOST EXTREMES OF THE PLASTIC BODY.
 4. DIMENSION b1 AND c1 APPLY TO BASE METAL ONLY.
 5. CONTROLLING DIMENSION: INCH.

D²Pak Part Marking Information (Lead-Free)

EXAMPLE: THIS IS AN IRF530S WITH
LOT CODE 8024
ASSEMBLED ON WW 02, 2000
IN THE ASSEMBLY LINE "L"

Note: "P" in assembly line
position indicates "Lead-Free"

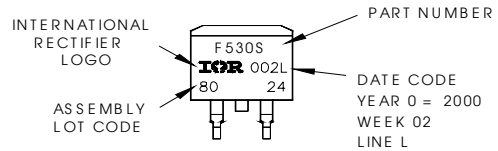

OR

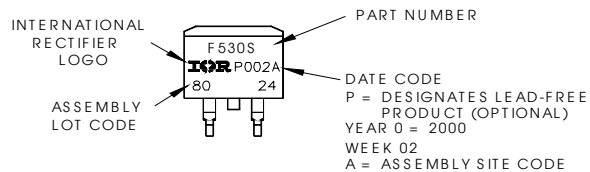

IRL3502SPbF

International
IR Rectifier

D²Pak Tape & Reel Information

Dimensions are shown in millimeters (inches)

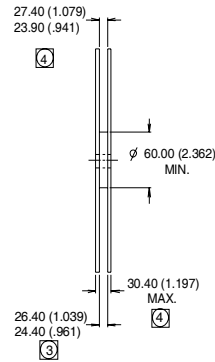
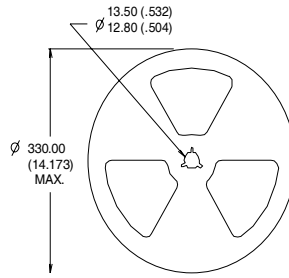
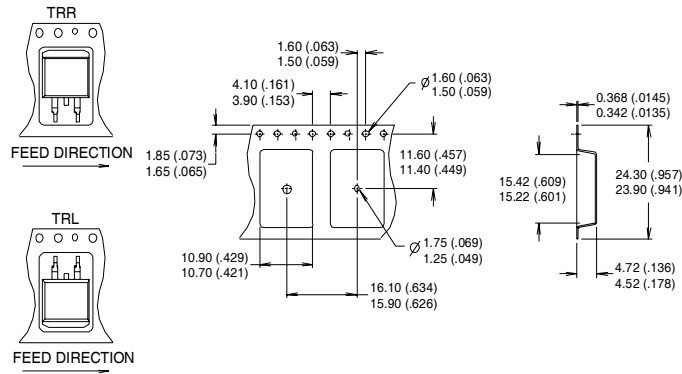

- NOTES:
1. CONFORMS TO EIA-418.
 2. CONTROLLING DIMENSION: MILLIMETER.
 3. DIMENSION MEASURED @ HUB.
 4. INCLUDES FLANGE DISTORTION @ OUTER EDGE.

Data and specifications subject to change without notice.

International
IR Rectifier

IR WORLD HEADQUARTERS: 233 Kansas St., El Segundo, California 90245, USA Tel: (310) 252-7105
TAC Fax: (310) 252-7903

Visit us at www.irf.com for sales contact information.03/04

Note: For the most current drawings please refer to the IR website at:
<http://www.irf.com/package/>