

Dual Line CAN Bus Protector

The NUP2105L has been designed to protect the CAN transceiver in high-speed and fault tolerant networks from ESD and other harmful transient voltage events. This device provides bidirectional protection for each data line with a single compact SOT-23 package, giving the system designer a low cost option for improving system reliability and meeting stringent EMI requirements.

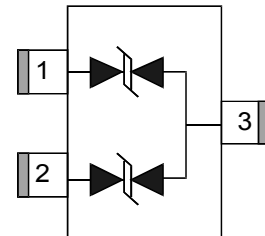

Features

- 350 W Peak Power Dissipation per Line (8 x 20sec Waveform)
- Low Reverse Leakage Current (< 100 nA)
- Low Capacitance High-Speed CAN Data Rates
- IEC Compatibility: – IEC 61000-4-2 (ESD): Level 4
 - IEC 61000-4-4 (EFT): 40 A – 5/50ns
 - IEC 61000-4-5 (Lighting) 8.0 A (8/20µs)
- ISO 7637-1, Nonrepetitive EMI Surge Pulse 2, 9.5 A (1 x 50µs)
- ISO 7637-3, Repetitive Electrical Fast Transient (EFT) EMI Surge Pulses, 50 A (5 x 50 ns)
- Flammability Rating UL 94 V-0
- AEC-Q101 Qualified and PPAP Capable
- SZ Prefix for Automotive and Other Applications Requiring Unique Site and Control Change Requirements
- Pb-Free Packages are Available*

Applications

- Industrial Control Networks
 - Smart Distribution Systems (SDS[®])
 - DeviceNet[™]
- Automotive Networks
 - Low and High-Speed CAN
 - Fault Tolerant CAN

MAXIMUM RATINGS (T_J = 25°C, unless otherwise specified)

Symbol	Rating	Value	Unit
PPK	Peak Power Dissipation 8 x 20 µs Double Exponential Waveform (Note 1)	350	W
T _J	Operating Junction Temperature Range	55 to 150	°C
T _J	Storage Temperature Range	–55 to 150	°C
T _L	Lead Solder Temperature (10 s)	260	°C
ESD	Human Body model (HBM)	16	kV
	Machine Model (MM)	400	V
	IEC 61000 - 4 - 2 Specification (Contact)	30	kV

Maximum ratings are those values beyond which device damage can occur. Maximum ratings applied to the device are individual stress limit values (not normal operating conditions) and are not valid simultaneously. If these limits are exceeded, device functional operation is not implied, damage may occur and reliability may be affected.

ELECTRICAL CHARACTERISTICS ($T_J = 25^\circ\text{C}$, unless otherwise specified)

Symbol	Parameter	Test Conditions	Min	Typ	Max	Unit
V_{RWM}	Reverse Working Voltage	(Note 2)	24	-	-	V
V_{BR}	Breakdown Voltage	$I_T = 1\text{ mA}$ (Note 3)	26.2	-	32	V
I_R	Reverse Leakage Current	$V_{RWM} = 24\text{ V}$	-	15	100	nA
V_C	Clamping Voltage	$I_{PP} = 5\text{ A}$ ($8 \times 20\mu\text{s}$ Waveform) (Note 4)	-	-	40	V
V_C	Clamping Voltage	$I_{PP} = 8\text{ A}$ ($8 \times 20\mu\text{s}$ Waveform) (Note 4)	-	-	44	V
I_{PP}	Maximum Peak Pulse Current	$8 \times 20\mu\text{s}$ Waveform (Note 4)	-	-	8.0	A
CJ	Capacitance	$V_R = 0\text{ V}$, $f = 1\text{ MHz}$ (Line to GND)	-	-	30	pF

1. Non-repetitive current pulse per Figure 1.
2. TVS devices are normally selected according to the working peak reverse voltage (V_{RWM}), which should be equal or greater than the DC or continuous peak operating voltage level.
3. V_{BR} is measured at pulse test current I_T .
4. Pulse waveform per Figure 1.

TYPICAL PERFORMANCE CURVES

($T_J = 25^\circ\text{C}$ unless otherwise noted)

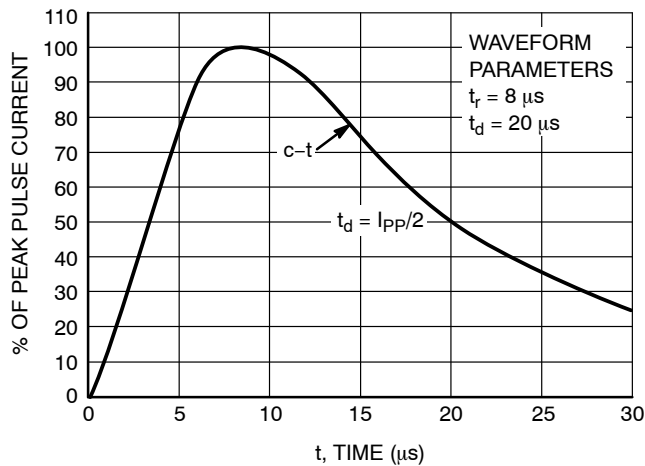

Figure 1. Pulse Waveform, $8 \times 20\mu\text{s}$

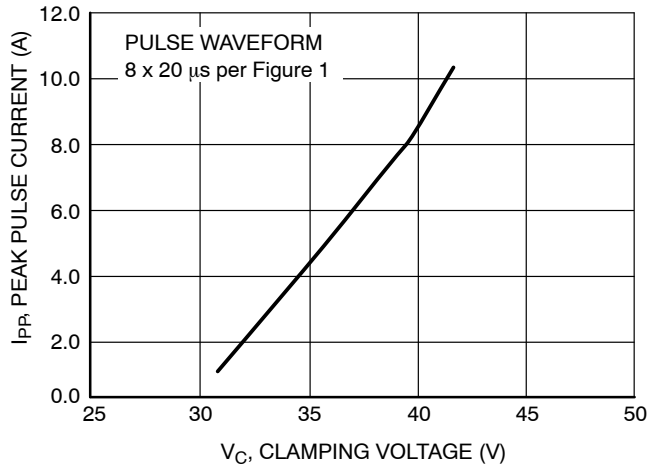

Figure 2. Clamping Voltage vs Peak Pulse Current

TYPICAL PERFORMANCE CURVES

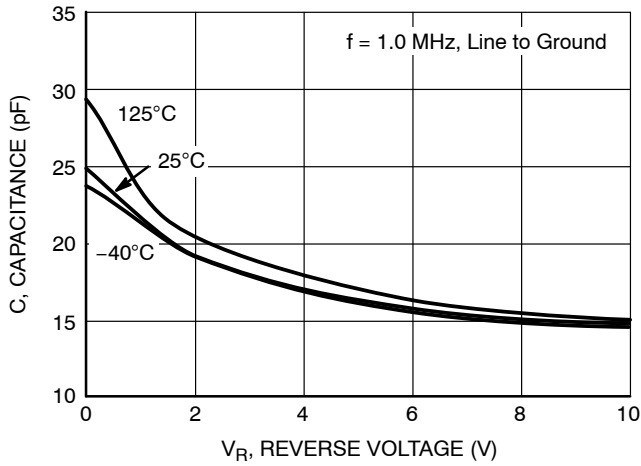

Figure 3. Typical Junction Capacitance vs Reverse Voltage

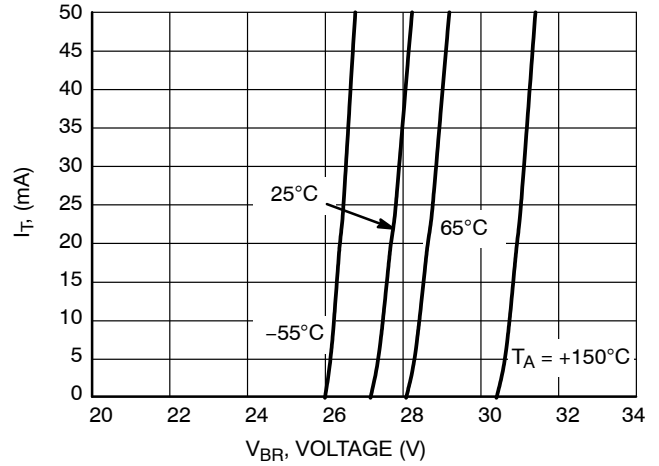

Figure 4. V_{BR} versus I_T Characteristics

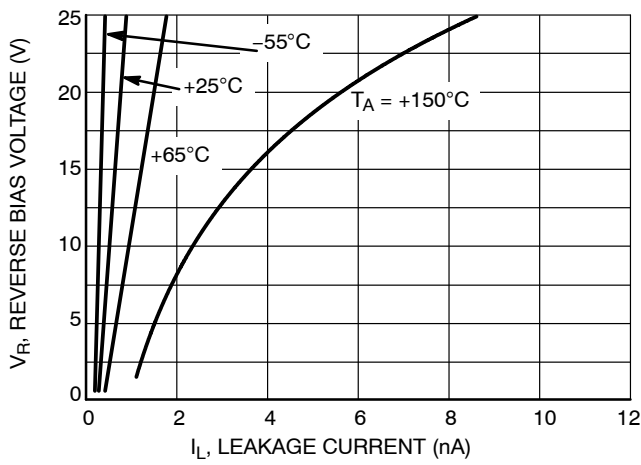

Figure 5. V_R versus Temperature Characteristics

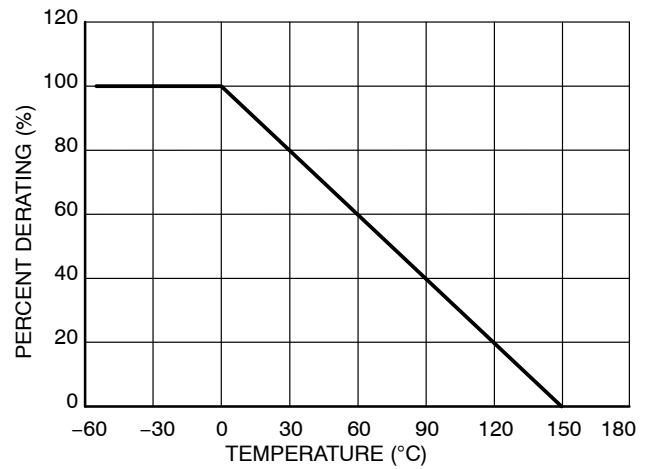
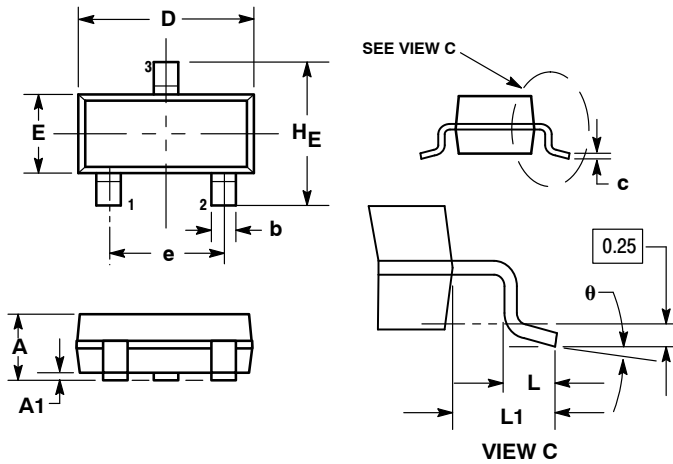

Figure 6. Temperature Power Dissipation Derating

Outline Drawing – SOT-23



DIM	MILLIMETERS			INCHES		
	MIN	NOM	MAX	MIN	NOM	MAX
A	0.89	1.00	1.11	0.035	0.040	0.044
A1	0.01	0.06	0.10	0.001	0.002	0.004
b	0.37	0.44	0.50	0.015	0.018	0.020
c	0.09	0.13	0.18	0.003	0.005	0.007
D	2.80	2.90	3.04	0.110	0.114	0.120
E	1.20	1.30	1.40	0.047	0.051	0.055
e	1.78	1.90	2.04	0.070	0.075	0.081
L	0.10	0.20	0.30	0.004	0.008	0.012
L1	0.35	0.54	0.69	0.014	0.021	0.029
HE	2.10	2.40	2.64	0.083	0.094	0.104
θ	0°	---	10°	0°	---	10°

STYLE 27:

- PIN 1. CATHODE
- 2. CATHODE
- 3. CATHODE

NOTES:

1. DIMENSIONING AND TOLERANCING PER ANSI Y14.5M, 1982.
2. CONTROLLING DIMENSION: INCH.
3. MAXIMUM LEAD THICKNESS INCLUDES LEAD FINISH THICKNESS. MINIMUM LEAD THICKNESS IS THE MINIMUM THICKNESS OF BASE MATERIAL.

Marking

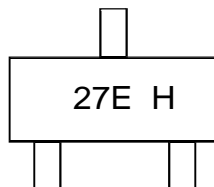

Ordering information

Order code	Package	Baseqty	Deliverymode
UMW NUP2105L	SOT-23	3000	Tape and reel