

High IP3 Frequency Mixer

SYM-20DHW+

Level 17 (LO Power +17 dBm) 10 to 2000 MHz



Generic photo used for illustration purposes only

CASE STYLE: TTT167

+RoHS Compliant

The +Suffix identifies RoHS Compliance. See our web site for RoHS Compliance methodologies and qualifications

Available Tape and Reel at no extra cost

Reel Size	Devices/Reel
7"	10, 20, 50, 100, 200
13"	500

Maximum Ratings

Operating Temperature	-40°C to 85°C
Storage Temperature	-55°C to 100°C
RF Power	200mW
IF Current	40mA
Permanent damage may occur if any of these limits are exceeded.	

Pin Connections

LO	2
RF	1
IF	3
GROUND	4,5,6

Outline Drawing

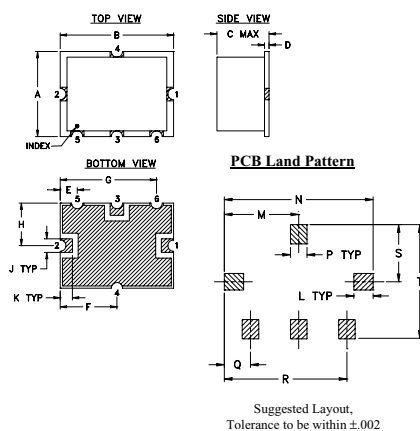

Outline Dimensions (inch/mm)

A	B	C	D	E	F	G	H	J	K
.38	.50	.23	.020	.075	.250	.425	.187	.050	.050
9.65	12.70	5.84	0.51	1.91	6.35	10.80	4.75	1.27	1.27
L	M	N	P	Q	R	S	T	wt.	
.070	.270	.540	.060	.095	.445	.208	.415	grams	
1.78	6.86	13.72	1.52	2.41	11.30	5.28	10.54	0.8	

Demo Board MCL P/N: TB-12 Suggested PCB Layout (PL-079)

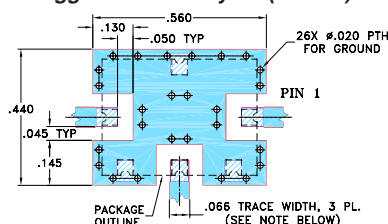

NOTE:

- TRACE WIDTH IS SHOWN FOR ROGERS RO4350B WITH DIELECTRIC THICKNESS .030" ± .002"; COPPER: 1/2 OZ. EACH SIDE. FOR OTHER MATERIALS, TRACE WIDTH MAY NEED TO BE MODIFIED.
- THE USE OF SOLDER MASK OVER THE GROUND AREA UNDER THE UNIT AS SHOWN IS RECOMMENDED TO PREVENT POTENTIAL SHORTING. IF USER CHOOSES TO EXPOSE METAL UNDER THE ENTIRE UNIT GROUND PAD FOR IMPROVED GROUNDING, IT IS RECOMMENDED A SOLDER MASK DAM BE APPLIED AROUND EACH GROUND PAD TO ENSURE FILLET AND CONNECTION AT GROUND PADS.
- BOTTOM SIDE OF THE PCB IS CONTINUOUS GROUND PLANE.

Notes

- Performance and quality attributes and conditions not expressly stated in this specification document are intended to be excluded and do not form a part of this specification document.
- Electrical specifications and performance data contained in this specification document are based on Mini-Circuit's applicable established test performance criteria and measurement instructions.
- The parts covered by this specification document are subject to Mini-Circuits standard limited warranty and terms and conditions (collectively, "Standard Terms"); Purchasers of this part are entitled to the rights and benefits contained therein. For a full statement of the Standard Terms and the exclusive rights and remedies thereunder, please visit Mini-Circuits' website at www.minicircuits.com/MCLStore/terms.jsp

Features

- low conversion loss, 6.2 dB typ.
- high IP3, 27 dBm typ.
- wideband, 10 to 2000 MHz
- excellent L-R isolation, 42 dB typ.; & L-I isolation, 40 dB typ.
- triple balanced mixer

Applications

- GPS
- UHF

Electrical Specifications

FREQUENCY (MHz)	CONVERSION LOSS (dB)		LO-RF ISOLATION (dB)			LO-IF ISOLATION (dB)			IP3 at center band (dBm)						
	LO/RF	IF	L	M	U	L	M	U							
10-2000	10-1800	6.2	33	20	40	25	37	22	44	30	42	28	34	22	27

1 dB COMP.: +14 dBm typ.

L = low range [f_l to 10 f_l]
m = mid band [$2f_l$ to $f_l/2$]

M = mid range [10 f_l to $f_l/2$]
U = upper range [$f_l/2$ to f_u]

Typical Performance Data

Frequency (MHz)		Conversion Loss (dB)	Isolation L-R (dB)	Isolation L-I (dB)	VSWR RF Port (:1)	VSWR LO Port (:1)
RF	LO	LO +17dBm	LO +17dBm	LO +17dBm	LO +17dBm	LO +17dBm
10.00	40.00	6.63	31.10	48.70	1.63	1.75
16.69	46.69	6.46	31.60	49.00	1.39	1.70
27.86	57.86	6.23	32.40	48.80	1.26	1.73
46.49	76.49	5.99	33.70	49.60	1.17	1.69
77.60	107.60	5.93	34.60	49.60	1.16	1.62
129.51	159.51	5.88	35.50	49.90	1.18	1.69
216.16	246.16	6.00	36.50	49.70	1.28	1.75
360.78	390.78	6.20	37.10	46.10	1.61	1.57
602.15	632.15	6.65	38.70	41.10	2.27	1.50
1005.00	1035.00	6.43	37.20	37.80	2.49	1.38
1104.50	1134.50	6.18	36.20	36.80	2.23	1.36
1204.00	1234.00	6.06	36.10	35.70	1.97	1.34
1303.50	1333.50	6.16	35.50	35.10	1.88	1.35
1403.00	1433.00	6.09	34.50	35.50	1.70	1.37
1502.50	1532.50	6.01	34.90	35.20	1.58	1.43
1602.00	1632.00	6.16	35.50	35.50	1.49	1.45
1700.00	1730.00	6.60	35.70	35.40	1.48	1.39
1801.00	1831.00	6.86	35.40	34.30	1.41	1.32
1900.50	1930.50	7.16	33.50	33.30	1.39	1.29
2000.00	2030.00	7.36	32.00	31.40	1.28	1.28

Electrical Schematic

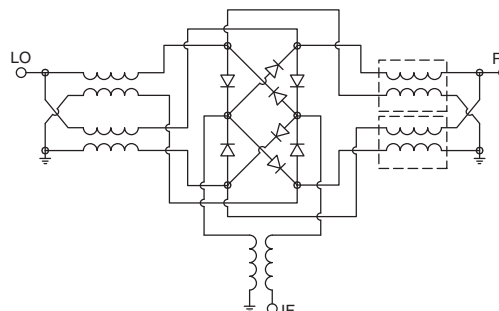

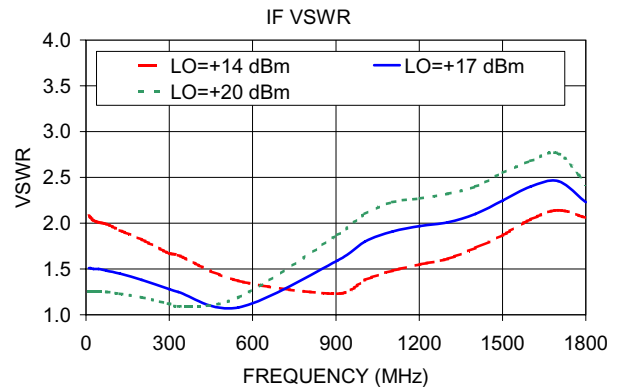
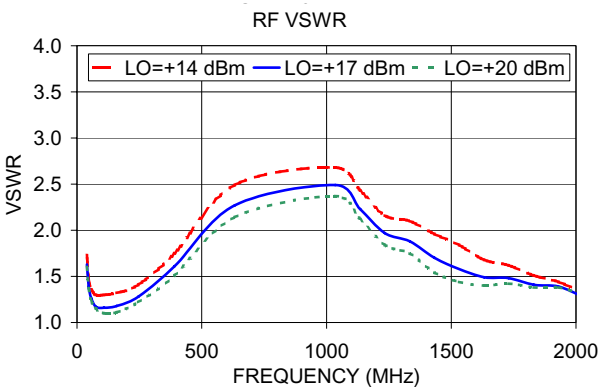
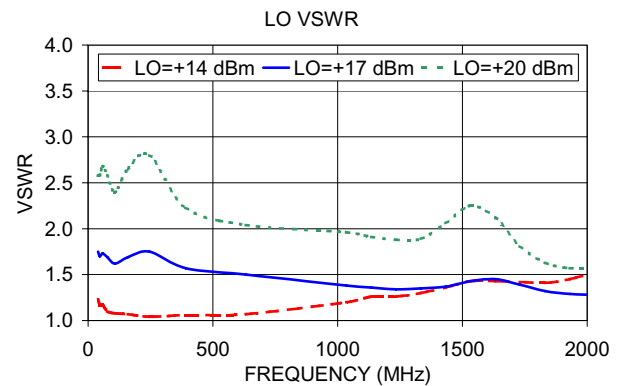
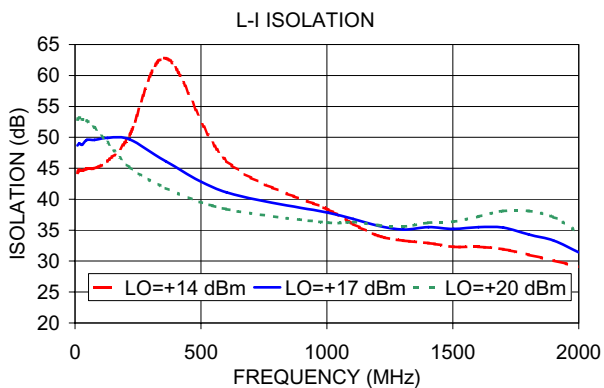
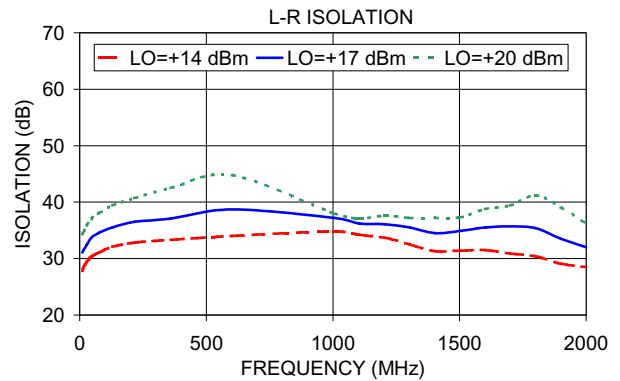
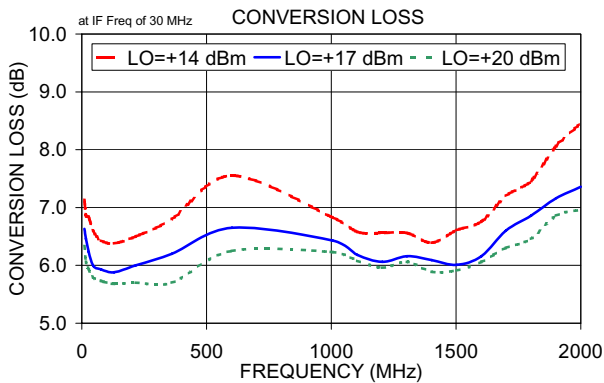

Notes

- A. Performance and quality attributes and conditions not expressly stated in this specification document are intended to be excluded and do not form a part of this specification document.
- B. Electrical specifications and performance data contained in this specification document are based on Mini-Circuit's applicable established test performance criteria and measurement instructions.
- C. The parts covered by this specification document are subject to Mini-Circuits standard limited warranty and terms and conditions (collectively, "Standard Terms"); Purchasers of this part are entitled to the rights and benefits contained therein. For a full statement of the Standard Terms and the exclusive rights and remedies thereunder, please visit Mini-Circuits' website at www.minicircuits.com/MCLStore/terms.jsp

