

# IS31FL3733

## 12x16 DOTS MATRIX LED DRIVER WITH INDIVIDUAL AUTO BREATH FUNCTION

December 2018

### GENERAL DESCRIPTION

The IS31FL3733 is a general purpose 12x16 LEDs matrix driver with 1/12 cycle rate. The device can be programmed via an I2C compatible interface. Each LED can be dimmed individually with 8-bit PWM data which allowing 256 steps of linear dimming.

IS31FL3733 features 3 Auto Breathing Modes which are noted as ABM-1, ABM-2 and ABM-3. For each Auto Breathing Mode, there are 4 timing characters which include current rising / holding / falling / off time and 3 loop characters which include Loop-Beginning / Loop-Ending / Loop-Times. Every LED can be configured to be any Auto Breathing Mode or No-Breathing Mode individually.

Additionally each LED open and short state can be detected, IS31FL3733 store the open or short information in Open-Short Registers. The Open-Short Registers allowing MCU to read out via I2C compatible interface. Inform MCU whether there are LEDs open or short and the locations of open or short LEDs.

The IS31FL3733 operates from 2.7V to 5.5V and features a very low shutdown and operational current.

IS31FL3733 is available in QFN-48 (6mmx6mm) and eTQFP-48 packages. It operates from 2.7V to 5.5V over the temperature range of -40°C to +125°C.

### FEATURES

- Supply voltage range: 2.7V to 5.5V
- 16 current source outputs for row control
- 12 switch current inputs for column scan control
- Up to 192 LEDs (12x16) in dot matrix
- Programmable 12x16 (64 RGBs) matrix size with de-ghost function
- 1MHz I2C-compatible interface
- Selectable 3 Auto Breath Modes for each dot
- Auto Breath Loop Features interrupt pin inform MCU Auto Breath Loop completed
- Auto Breath offers 128 steps gamma current, interrupt and state look up registers
- 256 steps Global Current Setting
- Individual on/off control
- Individual 256 PWM control steps
- Individual Auto Breath Mode select
- Individual open and short error detect function
- Cascade for synchronization of chips
- QFN-48 (6mmx6mm) and eTQFP-48 packages

### APPLICATIONS

- Hand-held devices for LED display
- Gaming device (Keyboard, Mouse etc.)
- LED in white goods application

### TYPICAL APPLICATION CIRCUIT

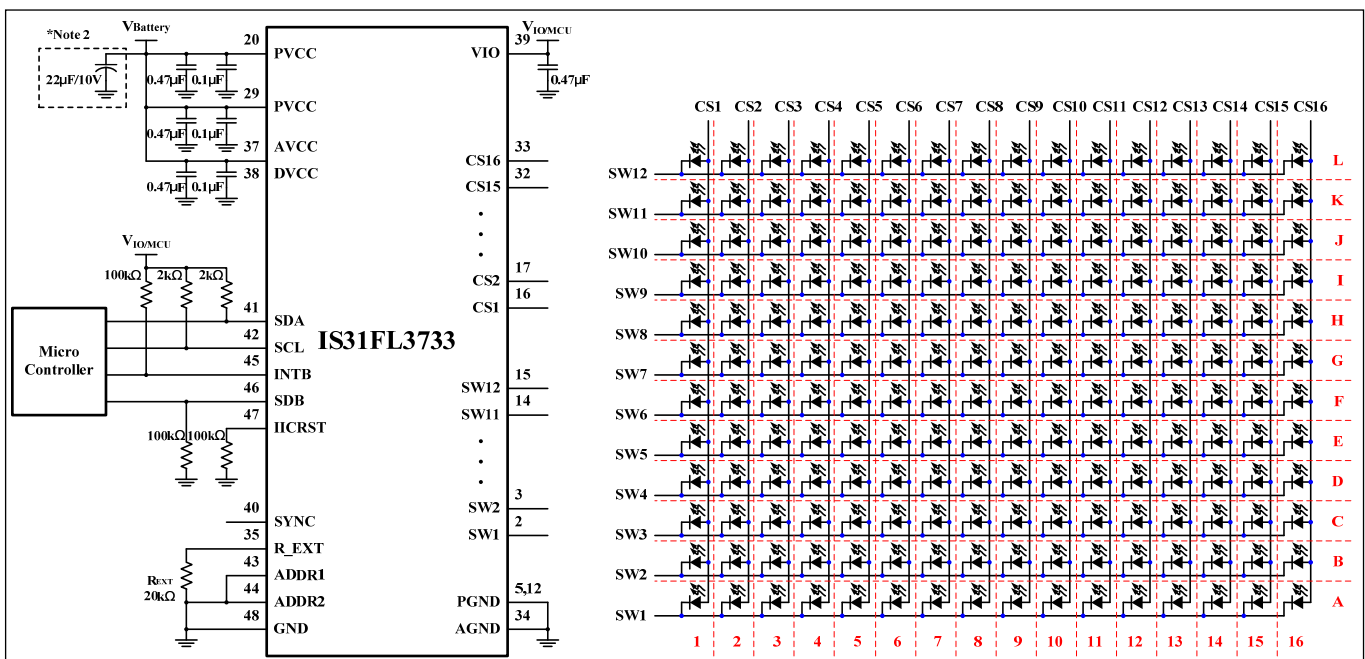

Figure 1 Typical Application Circuit (12x16)

# IS31FL3733

## TYPICAL APPLICATION CIRCUIT (CONTINUED)

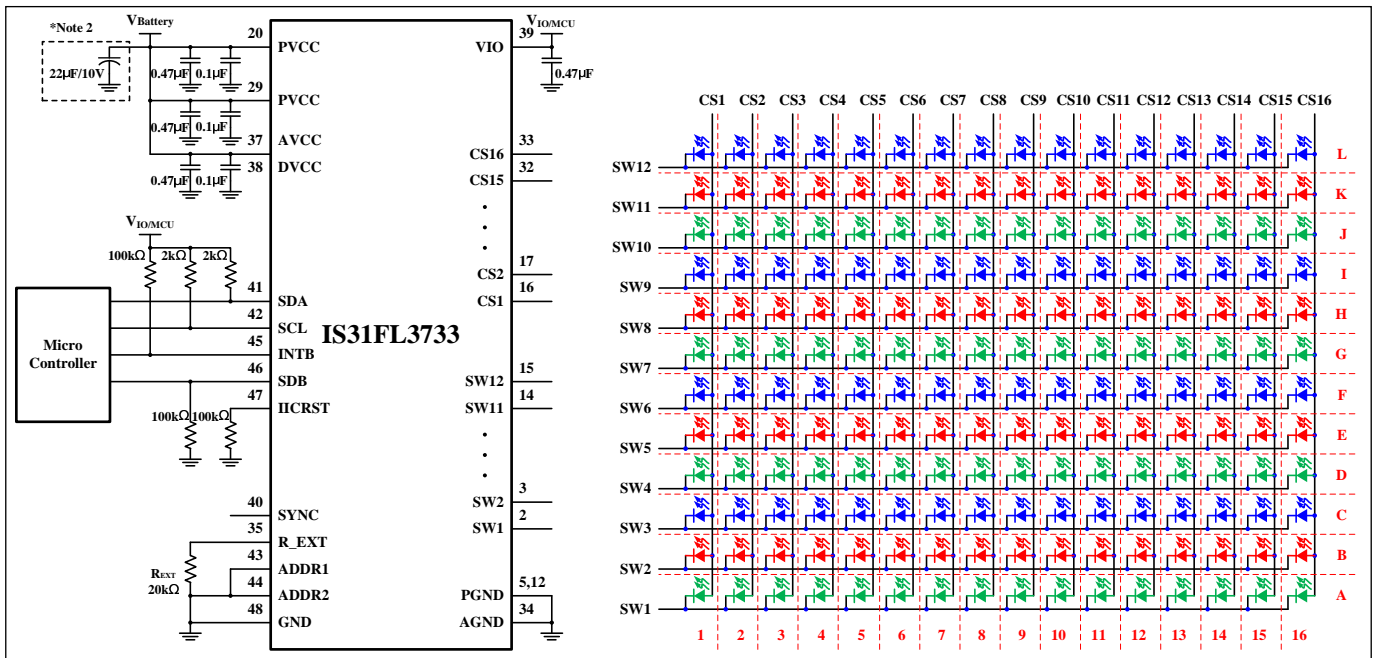

Figure 2 Typical Application Circuit (RGB)

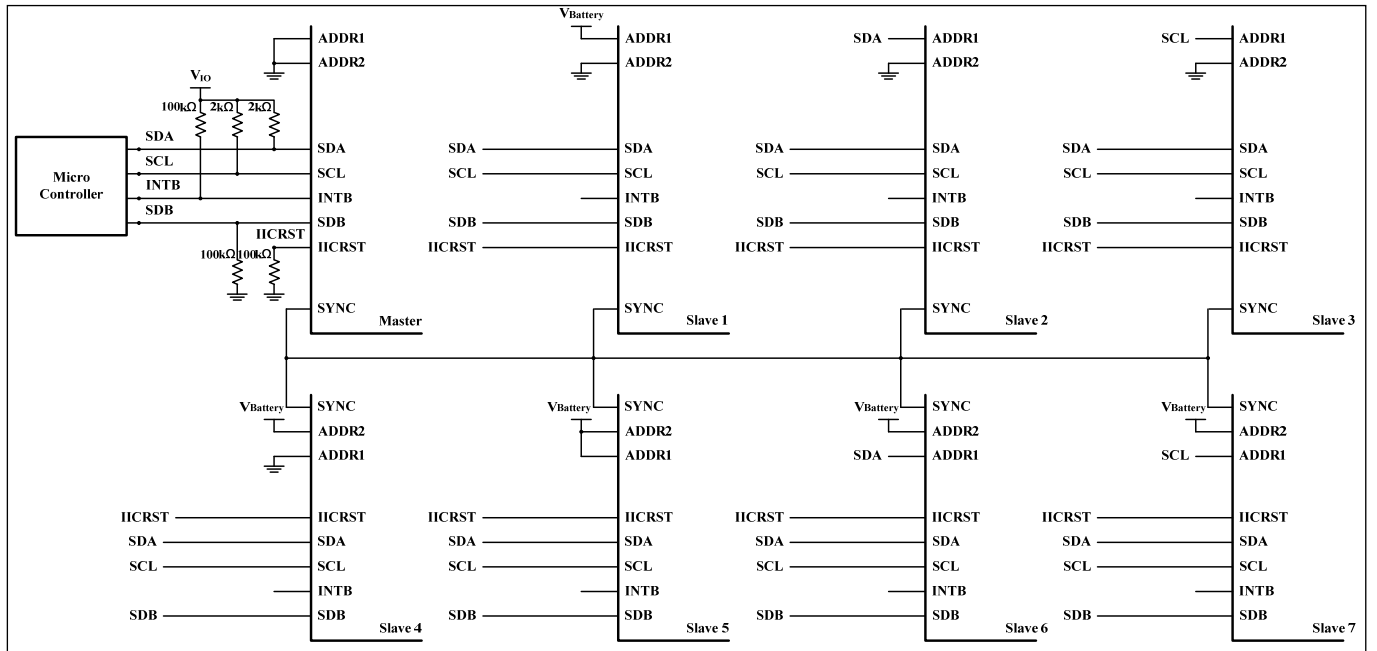

Figure 3 Typical Application Circuit (Eight Parts Synchronization-Work)

**Note 1:** IC should be placed far away from the antenna in order to prevent the EMI.

**Note 2:** Electrolytic/Tantalum Capacitor maybe considered for high current application to avoid audible noise interference.

**Note 3:** The V<sub>IO</sub> should be  $1.8V \leq V_{IO} \leq V_{CC}$ . And it is recommended to be equal to V<sub>OH</sub> of the micro controller. For example, if V<sub>OH</sub>=1.8V, set V<sub>IO</sub>=1.8V, if V<sub>OH</sub>=3.3V, set V<sub>IO</sub>=3.3V.

**Note 4:** One system should contain only one master, all slave parts should be configured as slave mode before the master is configured as master mode. Work as master mode or slave mode specified by Configuration Register (Function Register, address 00h). Master part output master clock, and all the other parts which work as slave input this master clock.

# IS31FL3733

## PIN CONFIGURATION

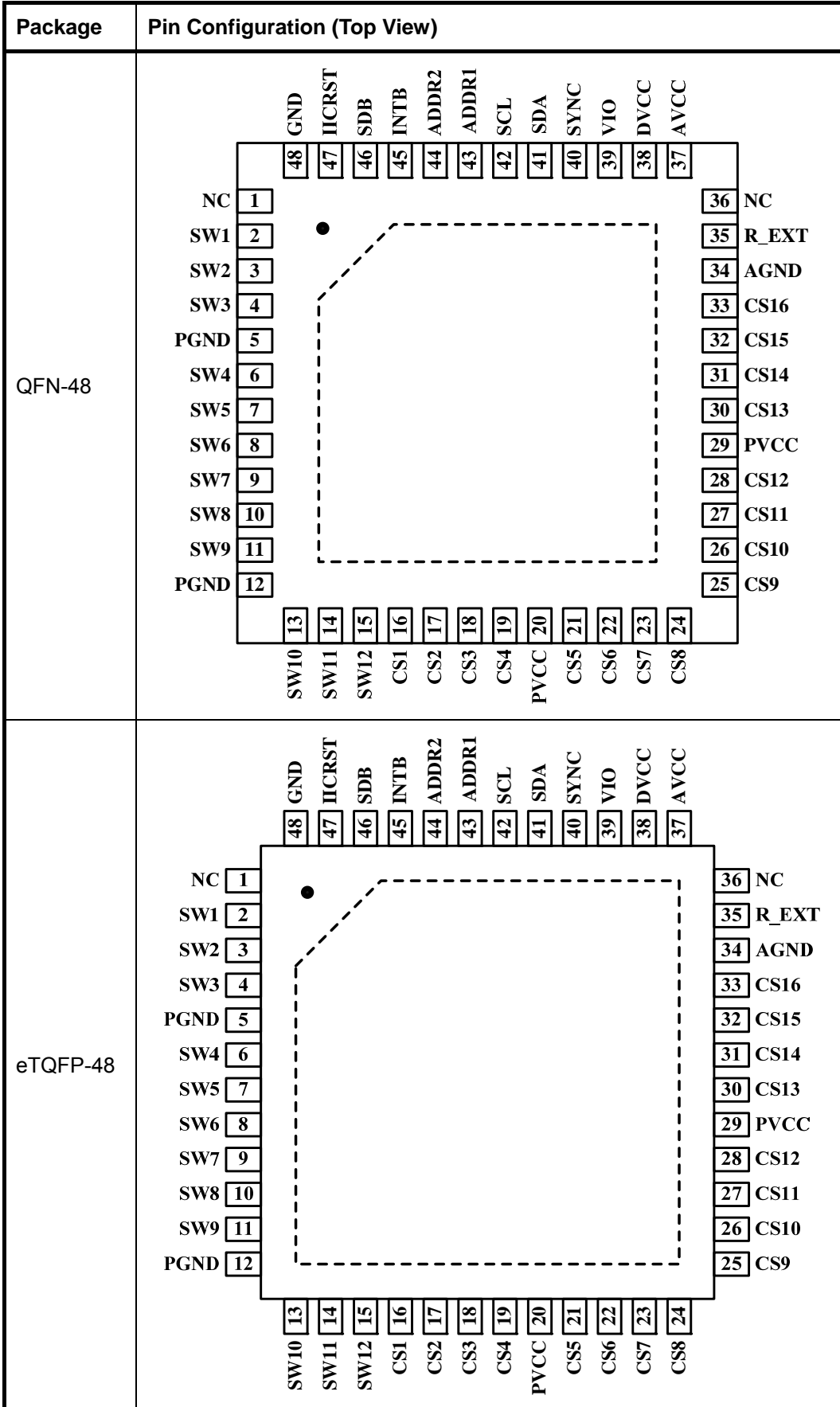

# IS31FL3733

## PIN DESCRIPTION

No.	Pin	Description
1,36	NC	Not connect.
2~4,6~11, 13~15	SW1~SW12	Switch pin for LED matrix scanning.
5,12	PGND	Power GND.
16~19, 21~28, 30~33	CS1~CS16	Current Source.
20, 29	PVCC	Power for current source.
34	AGND	Analog GND.
35	R_EXT	Input terminal used to connect an external resistor. This regulates current source DC current value.
37	AVCC	Power for analog circuits.
38	DVCC	Power for digital circuits.
39	VIO	Input logic reference voltage.
40	SYNC	Synchronize pin. It is used for more than one part work synchronize. If it is not used please float this pin.
41	SDA	I2C compatible serial data.
42	SCL	I2C compatible serial clock.
43	ADDR1	I2C address setting.
44	ADDR2	I2C address setting.
45	INTB	Interrupt output pin. Register F0h sets the function of the INTB pin and active low when the interrupt event happens. Can be NC (float) if interrupt function no used.
46	SDB	Shutdown the chip when pull to low.
47	IICRST	Reset I2C when pull high, need to pull down when normal operation.
48	GND	Connect to GND.
	Thermal Pad	Need to connect to GND pins.

# IS31FL3733

## ORDERING INFORMATION

Industrial Range: -40°C to +125°C

Order Part No.	Package	QTY
IS31FL3733-QFLS4-TR	QFN-48, Lead-free	2500/Reel
IS31FL3733-TQLS4	eTQFP-48, Lead-free	250/Tray

Copyright © 2018 Lumissil Microsystems. All rights reserved. Lumissil Microsystems reserves the right to make changes to this specification and its products at any time without notice. Lumissil Microsystems assumes no liability arising out of the application or use of any information, products or services described herein. Customers are advised to obtain the latest version of this device specification before relying on any published information and before placing orders for products.

Lumissil Microsystems does not recommend the use of any of its products in life support applications where the failure or malfunction of the product can reasonably be expected to cause failure of the life support system or to significantly affect its safety or effectiveness. Products are not authorized for use in such applications unless Lumissil Microsystems receives written assurance to its satisfaction, that:

- a.) the risk of injury or damage has been minimized;
- b.) the user assume all such risks; and
- c.) potential liability of Lumissil Microsystems is adequately protected under the circumstances

# IS31FL3733

## ABSOLUTE MAXIMUM RATINGS

Supply voltage, $V_{CC}$	-0.3V ~ +6.0V
Voltage at any input pin	-0.3V ~ $V_{CC}+0.3V$
Maximum junction temperature, $T_{JMAX}$	+150°C
Storage temperature range, $T_{STG}$	-65°C ~ +150°C
Operating temperature range, $T_A=T_J$	-40°C ~ +125°C
Package thermal resistance, junction to ambient (4 layer standard test PCB based on JESD 51-2A standard), $\theta_{JA}$	37.5°C/W (QFN) 39.0°C/W (eTQFP)
ESD (HBM)	±8kV
ESD (CDM)	±1kV

**Note 5:** Stresses beyond those listed under “Absolute Maximum Ratings” may cause permanent damage to the device. These are stress ratings only and functional operation of the device at these or any other condition beyond those indicated in the operational sections of the specifications is not implied. Exposure to absolute maximum rating conditions for extended periods may affect device reliability.

## ELECTRICAL CHARACTERISTICS

The following specifications apply for  $V_{CC} = 3.6V$ ,  $T_A = 25^\circ C$ , unless otherwise noted.

Symbol	Parameter	Conditions	Min.	Typ.	Max.	Unit
$V_{CC}$	Supply voltage		2.7		5.5	V
$I_{CC}$	Quiescent power supply current	$V_{SDB} = V_{CC}$ , all LEDs off		2	3	mA
		$V_{SDB} = V_{CC}$ , all LEDs off, GCC=0x12		2	3	
$I_{SD}$	Shutdown current	$V_{SDB} = 0V$		2	5	$\mu A$
		$V_{SDB} = V_{CC}$ , Configuration Register written “0000 0000”		2	5	
$I_{OUT}$	Maximum constant current of CS1~CS16	$R_{EXT} = 20k\Omega$ , GCC=255, PWM = 255	38	42	46	mA
		$R_{EXT} = 20k\Omega$ , GCC=0x12, PWM = 255	2.66	2.95	3.25	mA
$I_{LED}$	Average current on each LED $I_{LED} = I_{OUT}/12.75$	$R_{EXT} = 20k\Omega$ , GCC=255, PWM = 255	3.05	3.29	3.61	mA
$V_{HR}$	Current sink headroom voltage SW1~SW12	$I_{SINK} = 672mA$ (Note 6, 7)		300	400	mV
		$I_{SINK} = 48mA$ , GCC=0x12			100	
	Current source headroom voltage CS1~C16	$I_{SOURCE} = 42mA$ (Note 6)		150	200	
		$I_{SOURCE} = 3mA$ , GCC=0x12			100	
$t_{SCAN}$	Period of scanning		115	128	140	$\mu s$
$t_{NOL}$	Non-overlap blanking time during scan, the SWy and CSx are all off during this time		7.2	8	8.75	$\mu s$

## Logic Electrical Characteristics (SDA, SCL, ADDR1, ADDR2, SYNC, SDB)

$V_{IL}$	Logic “0” input voltage	$V_{IO}=3.6V$	GND		$0.2V_{IO}$	V
$V_{IH}$	Logic “1” input voltage	$V_{IO}=3.6V$	$0.75V_{IO}$		$V_{IO}$	V
$V_{HYS}$	Input Schmitt trigger hysteresis	$V_{IO}=3.6V$		0.2		V
$V_{OL}$	Logic “0” output voltage for SYNC	$I_{OL} = 8mA$			0.4	V
$V_{OH}$	Logic “1” output voltage for SYNC	$I_{OH} = 8mA$	$0.75V_{IO}$			V
$I_{IL}$	Logic “0” input current	$V_{INPUT} = 0V$ (Note 8)		5		nA
$I_{IH}$	Logic “1” input current	$V_{INPUT} = V_{IO}$ (Note 8)		5		nA

# IS31FL3733

## DIGITAL INPUT SWITCHING CHARACTERISTICS (NOTE 8)

Symbol	Parameter	Fast Mode			Fast Mode Plus			Units
		Min.	Typ.	Max.	Min.	Typ.	Max.	
$f_{SCL}$	Serial-clock frequency	-		400	-		1000	kHz
$t_{BUF}$	Bus free time between a STOP and a START condition	1.3		-	0.5		-	$\mu$ s
$t_{HD, STA}$	Hold time (repeated) START condition	0.6		-	0.26		-	$\mu$ s
$t_{SU, STA}$	Repeated START condition setup time	0.6		-	0.26		-	$\mu$ s
$t_{SU, STO}$	STOP condition setup time	0.6		-	0.26		-	$\mu$ s
$t_{HD, DAT}$	Data hold time	-		-	-		-	$\mu$ s
$t_{SU, DAT}$	Data setup time	100		-	50		-	ns
$t_{LOW}$	SCL clock low period	1.3		-	0.5		-	$\mu$ s
$t_{HIGH}$	SCL clock high period	0.7		-	0.26		-	$\mu$ s
$t_R$	Rise time of both SDA and SCL signals, receiving	-		300	-		120	ns
$t_F$	Fall time of both SDA and SCL signals, receiving	-		300	-		120	ns

**Note 6:** In case of  $R_{EXT} = 20k\Omega$ , Global Current Control Register (PG3, 01h) written "1111 1111", GCC = "1111 1111".

**Note 7:** All LEDs are on and PWM = "1111 1111", GCC = "1111 1111".

**Note 8:** Guaranteed by design.

# IS31FL3733

## FUNCTIONAL BLOCK DIAGRAM

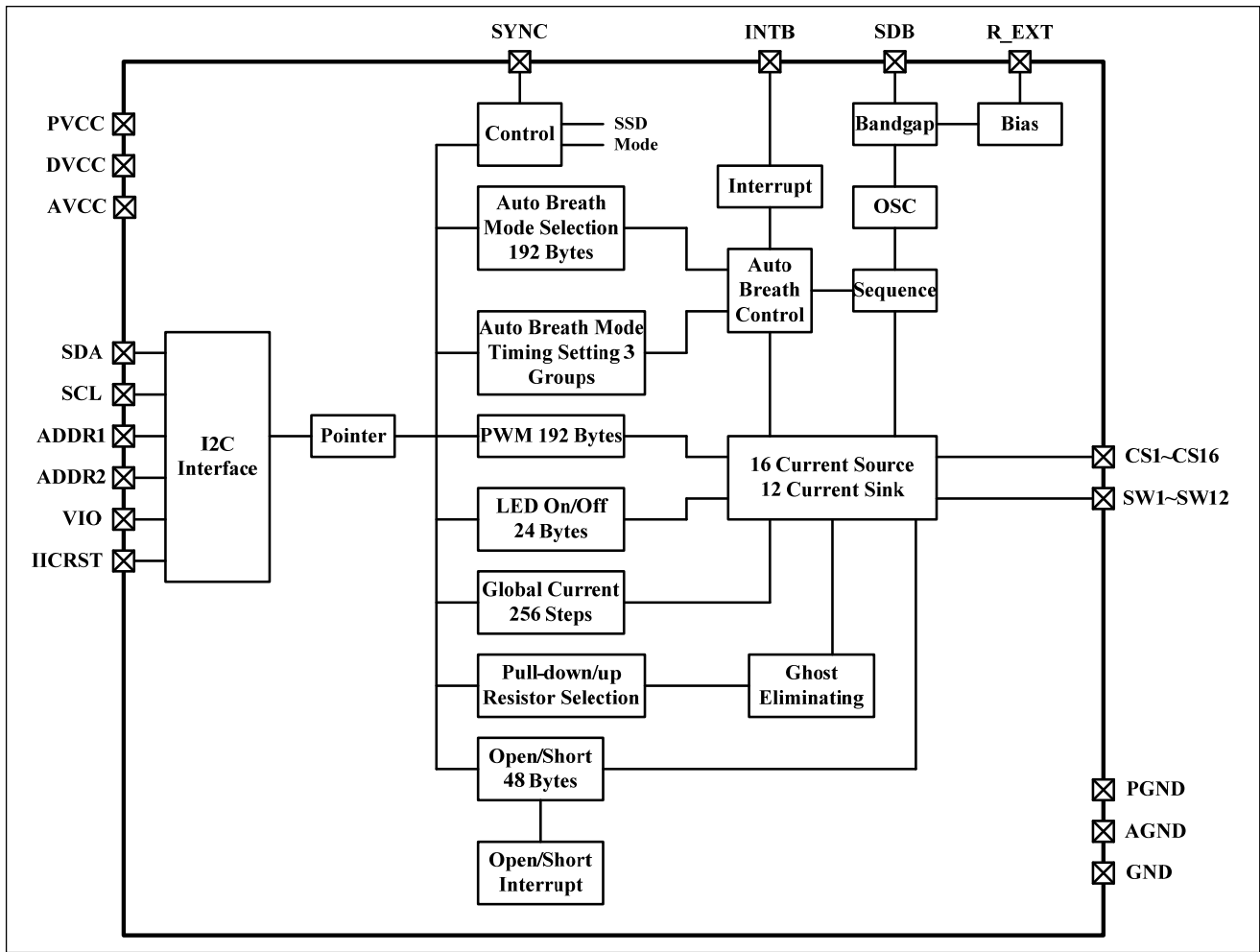



# IS31FL3733

## DETAILED DESCRIPTION

### I2C INTERFACE

The IS31FL3733 uses a serial bus, which conforms to the I2C protocol, to control the chip's functions with two wires: SCL and SDA. The IS31FL3733 has a 7-bit slave address (A7:A1), followed by the R/W bit, A0. Set A0 to "0" for a write command and set A0 to "1" for a read command. The value of bits A1 and A2 are decided by the connection of the ADDR1 pin. The value of bits A3 and A4 are decided by the connection of the ADDR2 pin.

The complete slave address is:

**Table 1 Slave Address:**

ADDR2	ADDR1	A7:A5	A4:A3	A2:A1	A0
GND	GND	101	00	00	0/1
GND	SCL		00	01	
GND	SDA		00	10	
GND	VCC		00	11	
SCL	GND		01	00	
SCL	SCL		01	01	
SCL	SDA		01	10	
SCL	VCC		01	11	
SDA	GND		10	00	
SDA	SCL		10	01	
SDA	SDA		10	10	
SDA	VCC		10	11	
VCC	GND		11	00	
VCC	SCL		11	01	
VCC	SDA		11	10	
VCC	VCC		11	11	

ADDR1/2 connected to GND, (A2:A1)/(A4:A3)=00;

ADDR1/2 connected to VCC, (A2:A1)/(A4:A3)=11;

ADDR1/2 connected to SCL, (A2:A1)/(A4:A3)=01;

ADDR1/2 connected to SDA, (A2:A1)/(A4:A3)=10;

The SCL line is uni-directional. The SDA line is bi-directional (open-collector) with a pull-up resistor (typically 1kΩ). The maximum clock frequency specified by the I2C standard is 1MHz. In this discussion, the master is the microcontroller and the slave is the IS31FL3733.

The timing diagram for the I2C is shown in Figure 4. The SDA is latched in on the stable high level of the SCL. When there is no interface activity, the SDA line should be held high.

The "START" signal is generated by lowering the SDA signal while the SCL signal is high. The start signal will alert all devices attached to the I2C bus to check the incoming address against their own chip address.

The 8-bit chip address is sent next, most significant bit first. Each address bit must be stable while the SCL level is high.

After the last bit of the chip address is sent, the master checks for the IS31FL3733's acknowledge. The master releases the SDA line high (through a pull-up resistor). Then the master sends an SCL pulse. If the IS31FL3733 has received the address correctly, then it holds the SDA line low during the SCL pulse. If the SDA line is not low, then the master should send a "STOP" signal (discussed later) and abort the transfer.

Following acknowledge of IS31FL3733, the register address byte is sent, most significant bit first. IS31FL3733 must generate another acknowledge indicating that the register address has been received.

Then 8-bit of data byte are sent next, most significant bit first. Each data bit should be valid while the SCL level is stable high. After the data byte is sent, the IS31FL3733 must generate another acknowledge to indicate that the data was received.

The "STOP" signal ends the transfer. To signal "STOP", the SDA signal goes high while the SCL signal is high.

### ADDRESS AUTO INCREMENT

To write multiple bytes of data into IS31FL3733, load the address of the data register that the first data byte is intended for. During the IS31FL3733 acknowledge of receiving the data byte, the internal address pointer will increment by one. The next data byte sent to IS31FL3733 will be placed in the new address, and so on. The auto increment of the address will continue as long as data continues to be written to IS31FL3733 (Figure 7).

### READING OPERATION

Register FEh, F1h, 18h~45h of Page 0 and 11h of Page 3 can be read.

To read the FEh and F1h, after I2C start condition, the bus master must send the IS31FL3733 device address with the R/W bit set to "0", followed by the register address (FEh or F1h) which determines which register is accessed. Then restart I2C, the bus master should send the IS31FL3733 device address with the R/W bit set to "1". Data from the register defined by the command byte is then sent from the IS31FL3733 to the master (Figure 8).

To read the 18h~45h of Page 0 and 11h of Page 3, the FDh should write with 00h before follow the Figure 8 sequence to read the data, that means, when you want to read 18h~45h of Page 0 and 11h of Page 3 the FDh should point to Page 0 first and you can read the Page 0 data.

# IS31FL3733

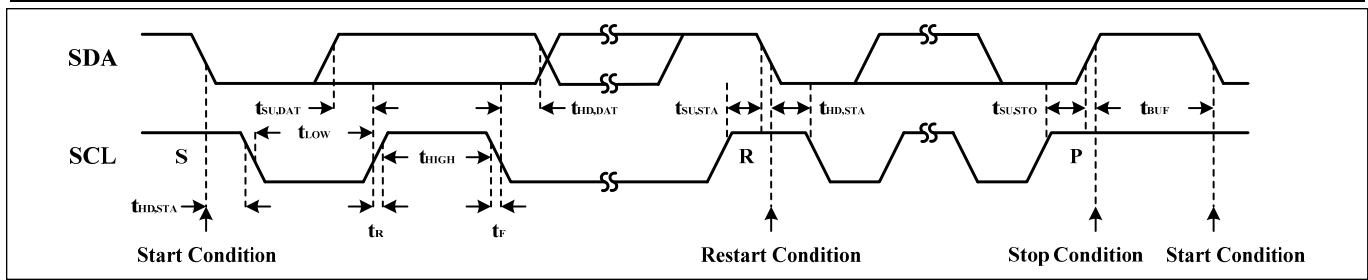

Figure 4 Interface Timing

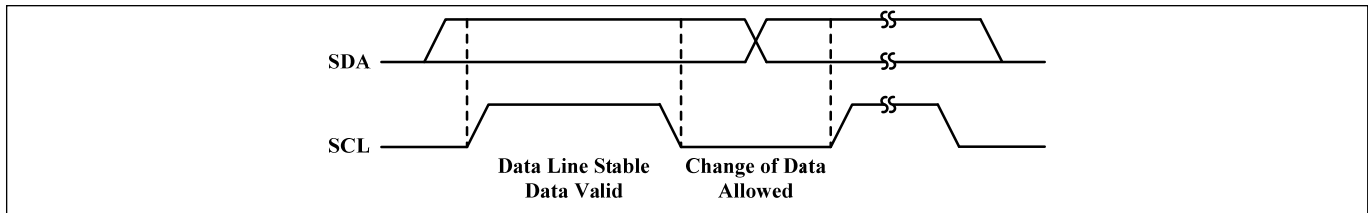

Figure 5 Bit Transfer

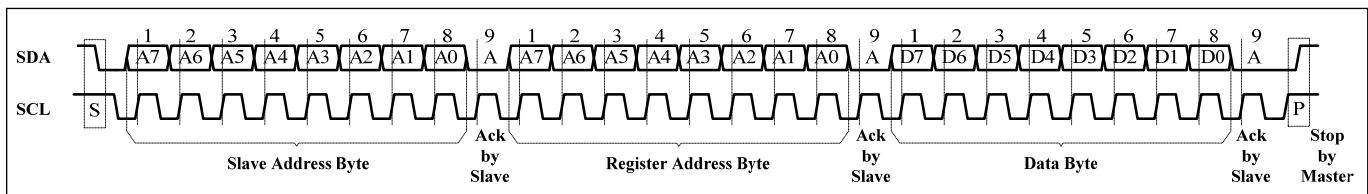

Figure 6 Writing to IS31FL3733 (Typical)

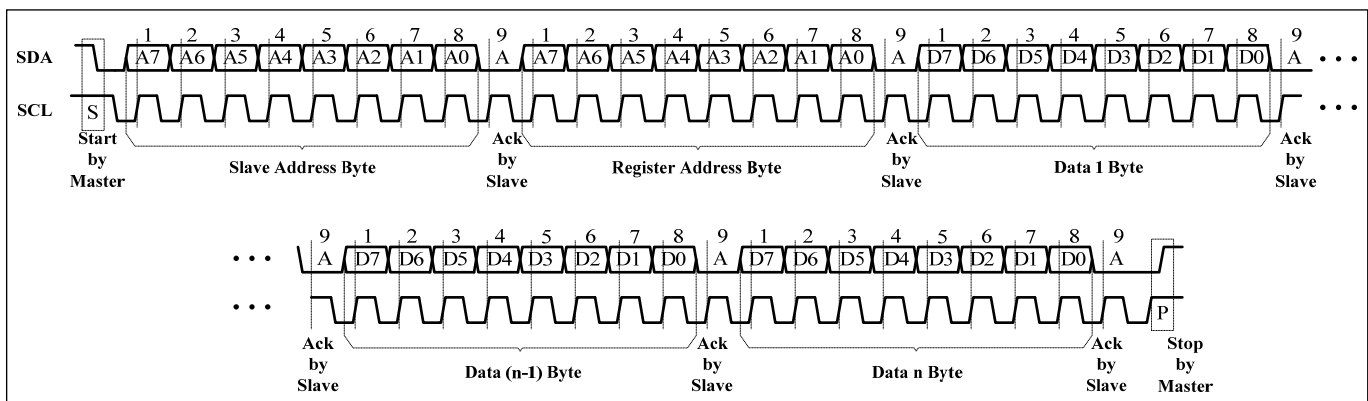

Figure 7 Writing to IS31FL3733 (Automatic Address Increment)

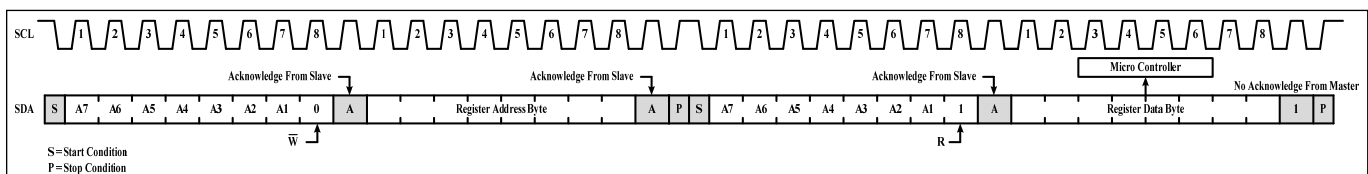

Figure 8 Reading from IS31FL3733

# IS31FL3733

## REGISTER DEFINITION-1

Address	Name	Function	Table	R/W	Default
FDh	Command Register	Available Page 0 to Page 3 Registers	2	W	xxxx xxxx
FEh	Command Register Write lock	To lock/unlock Command Register	3	R/W	0000 0000
F0h	Interrupt Mask Register	Configure the interrupt function	4	W	
F1h	Interrupt Status Register	Show the interrupt status	5	R	

## REGISTER CONTROL

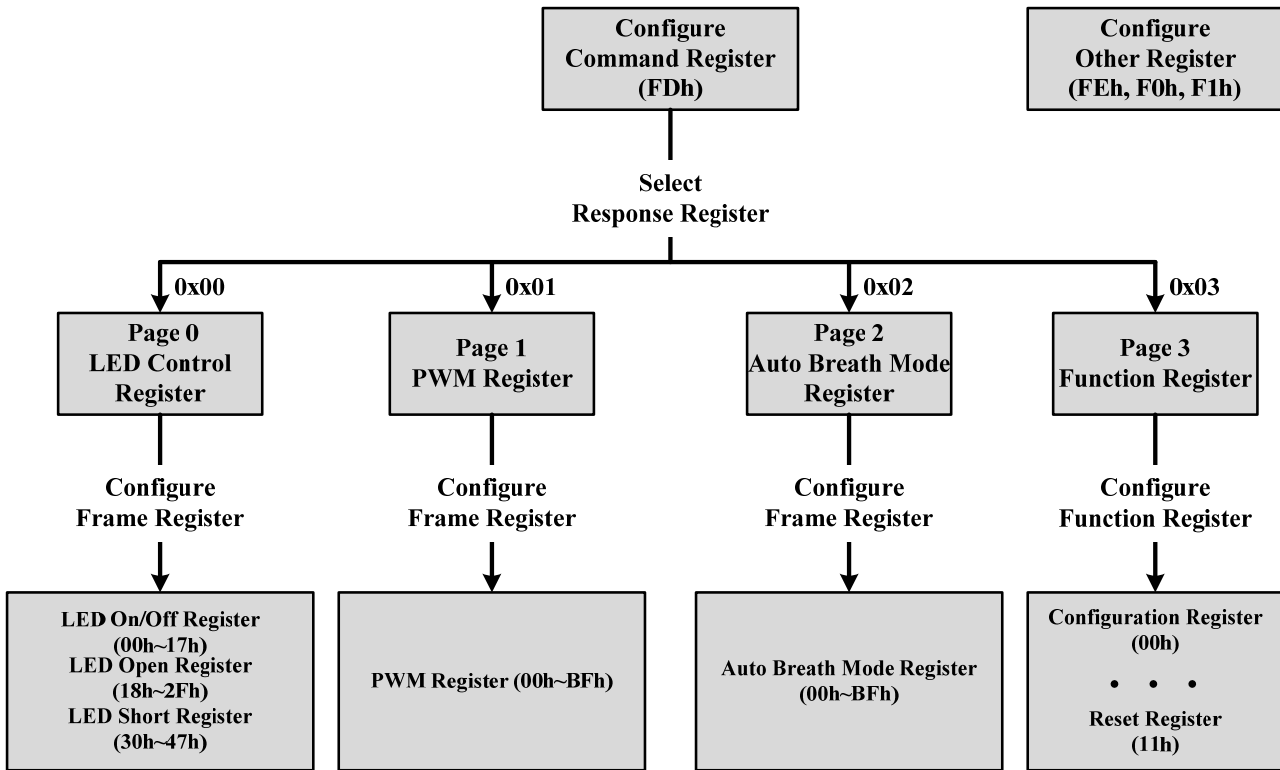

**Table 2 FDh Command Register (Write Only)**

Data	Function
0000 0000	Point to Page 0 (PG0, LED Control Register is available)
0000 0001	Point to Page 1 (PG1, PWM Register is available)
0000 0010	Point to Page 2 (PG2, Auto Breath Mode Register is available)
0000 0011	Point to Page 3 (PG3, Function Register is available)
Others	Reserved

**Note:** FDh is locked when power up, need to unlock this register before write command to it. See Table 3 for detail.

The Command Register should be configured first after writing in the slave address to choose the available register. Then write data in the choosing register. Power up default state is "0000 0000".

For example, when write "0000 0001" in the Command Register (FDh), the data which writing after will be stored in the PWM Register (Page1). Write new data can configure other registers.

# IS31FL3733

**Table 3 FEh Command Register Write Lock (Read/Write)**

Bit	D7:D0
Name	CRWL
Default	0000 0000 (FDh write disable)

To select the PG0~PG3, need to unlock this register first, with the purpose to avoid misoperation of this register. When FEh is written with 0xC5, FDh is allowed to modify once, after the FDh is modified the FEh will reset to be 0x00 at once.

**CRWL** Command Register Write Lock  
 0x00 FDh write disable  
 0xC5 FDh write enable once

**Table 4 F0h Interrupt Mask Register (Write Only)**

Bit	D7:D4	D3	D2	D1	D0
Name	-	IAC	IAB	IS	IO
Default	0000	0	0	0	0

Configure the interrupt function for IC.

**IAC** Auto Clear Interrupt Bit  
 0 Interrupt could not auto clear  
 1 Interrupt auto clear when INTB stay low exceeds 8ms

**IAB** Auto Breath Interrupt Bit  
 0 Disable auto breath loop finish interrupt  
 1 Enable auto breath loop finish interrupt

**IS** Dot Short Interrupt Bit  
 0 Disable dot short interrupt  
 1 Enable dot short interrupt

**IO** Dot Open Interrupt Bit  
 0 Disable dot open interrupt  
 1 Enable dot open interrupt

**Table 5 F1h Interrupt Status Register (Read Only)**

Bit	D7:D5	D4	D3	D2	D1	D0
Name	-	ABM3	ABM2	ABM1	SB	OB
Default	000	0	0	0	0	0

Show the interrupt status for IC.

**ABM3** Auto Breath Mode 3 Finish Bit  
 0 ABM3 not finish  
 1 ABM3 finish

**ABM2** Auto Breath Mode 2 Finish Bit  
 0 ABM2 not finish  
 1 ABM2 finish

**ABM1** Auto Breath Mode 1 Finish Bit  
 0 ABM1 not finish  
 1 ABM1 finish

**SB** Short Bit  
 0 No short  
 1 Short happens

**OB** Open Bit  
 0 No open  
 1 Open happens

# IS31FL3733

## REGISTER DEFINITION-2

Address	Name	Function	Table	R/W	Default
<b>PG0 (0x00): LED Control Register</b>					
00h ~ 17h	LED On/Off Register	Set on or off state for each LED	7	W	0000 0000
18h ~ 2Fh	LED Open Register	Store open state for each LED	8	R	
30h ~ 47h	LED Short Register	Store short state for each LED	9	R	
<b>PG1 (0x01): PWM Register</b>					
00h~BFh	PWM Register	Set PWM duty for LED	10	W	0000 0000
<b>PG2 (0x02): Auto Breath Mode Register</b>					
00h~BFh	Auto Breath Mode Register	Set operating mode of each dot	11	W	0000 0000
<b>PG3 (0x03) : Function Register</b>					
00h	Configuration Register	Configure the operation mode	13	W	0000 0000
01h	Global Current Control Register	Set the global current	14	W	
02h	Auto Breath Control Register 1 of ABM-1	Set fade in and hold time for breath function of ABM-1	15	W	
03h	Auto Breath Control Register 2 of ABM-1	Set the fade out and off time for breath function of ABM-1	16	W	
04h	Auto Breath Control Register 3 of ABM-1	Set loop characters of ABM-1	17	W	
05h	Auto Breath Control Register 4 of ABM-1	Set loop characters of ABM-1	18	W	
06h	Auto Breath Control Register 1 of ABM-2	Set fade in and hold time for breath function of ABM-2	15	W	
07h	Auto Breath Control Register 2 of ABM-2	Set the fade out and off time for breath function of ABM-2	16	W	
08h	Auto Breath Control Register 3 of ABM-2	Set loop characters of ABM-2	17	W	
09h	Auto Breath Control Register 4 of ABM-2	Set loop characters of ABM-2	18	W	
0Ah	Auto Breath Control Register 1 of ABM-3	Set fade in and hold time for breath function of ABM-3	15	W	
0Bh	Auto Breath Control Register 2 of ABM-3	Set the fade out and off time for breath function of ABM-3	16	W	
0Ch	Auto Breath Control Register 3 of ABM-3	Set loop characters of ABM-3	17	W	
0Dh	Auto Breath Control Register 4 of ABM-3	Set loop characters of ABM-3	18	W	
0Eh	Time Update Register	Update the setting of 02h ~ 0Dh registers	-	W	
0Fh	SWy Pull-Up Resistor Selection Register	Set the pull-up resistor for SWy	19	W	
10h	CSx Pull-Down Resistor Selection Register	Set the pull-down resistor for CSx	20	W	
11h	Reset Register	Reset all register to POR state	-	R	

# IS31FL3733

**Table 6 Page 0 (PG0, 0x00): LED Control Register**

LED Location		LED On/Off Register		LED Open Register		LED Short Register	
<b>SW1(CS1~ CS8)</b>	SW1(CS9~ CS16)	<b>00h</b>	01h	<b>18h</b>	19h	<b>30h</b>	31h
<b>SW2(CS1~ CS8)</b>	SW2(CS9~ CS16)	<b>02h</b>	03h	<b>1Ah</b>	1Bh	<b>32h</b>	33h
<b>SW3(CS1~ CS8)</b>	SW3(CS9~ CS16)	<b>04h</b>	05h	<b>1Ch</b>	1Dh	<b>34h</b>	35h
<b>SW4(CS1~ CS8)</b>	SW4(CS9~ CS16)	<b>06h</b>	07h	<b>1Eh</b>	1Fh	<b>36h</b>	37h
<b>SW5(CS1~ CS8)</b>	SW5(CS9~ CS16)	<b>08h</b>	09h	<b>20h</b>	21h	<b>38h</b>	39h
<b>SW6(CS1~ CS8)</b>	SW6(CS9~ CS16)	<b>0Ah</b>	0Bh	<b>22h</b>	23h	<b>3Ah</b>	3Bh
<b>SW7(CS1~ CS8)</b>	SW7(CS9~ CS16)	<b>0Ch</b>	0Dh	<b>24h</b>	25h	<b>3Ch</b>	3Dh
<b>SW8(CS1~ CS8)</b>	SW8(CS9~ CS16)	<b>0Eh</b>	0Fh	<b>26h</b>	27h	<b>3Eh</b>	3Fh
<b>SW9(CS1~ CS8)</b>	SW9(CS9~ CS16)	<b>10h</b>	11h	<b>28h</b>	29h	<b>40h</b>	41h
<b>SW10(CS1~ CS8)</b>	SW10(CS9~ CS16)	<b>12h</b>	13h	<b>2Ah</b>	2Bh	<b>42h</b>	43h
<b>SW11(CS1~ CS8)</b>	SW11(CS9~ CS16)	<b>14h</b>	15h	<b>2Ch</b>	2Dh	<b>44h</b>	45h
<b>SW12(CS1~ CS8)</b>	SW12(CS9~ CS16)	<b>16h</b>	17h	<b>2Eh</b>	2Fh	<b>46h</b>	47h

**Table 7 00h ~ 17h LED On/Off Register**

Bit	D7:D0
Name	$C_{CS8} : C_{CS1}$ or $C_{CS16} : C_{CS9}$
Default	0000 0000

The LED On/Off Registers store the on or off state of each LED in the Matrix.

**C<sub>x-y</sub>** LED State Bit  
 0 LED off  
 1 LED on

**Table 9 30h ~ 47h LED Short Register**

Bit	D7:D0
Name	$ST_8 : ST_1$ or $ST_{16} : ST_9$
Default	0000 0000

The LED Short Registers store the short or normal state of each LED in the Matrix.

**ST<sub>x</sub>** LED Short Bit  
 0 LED normal  
 1 LED short

**Table 8 18h ~ 2Fh LED Open Register**

Bit	D7:D0
Name	$OP_8 : OP_1$ or $OP_{16} : OP_9$
Default	0000 0000

The LED Open Registers store the open or normal state of each LED in the Matrix.

**OP<sub>x</sub>** LED Open Bit  
 0 LED normal  
 1 LED open

# IS31FL3733

## Page 1 (PG1, 0x01): PWM Register

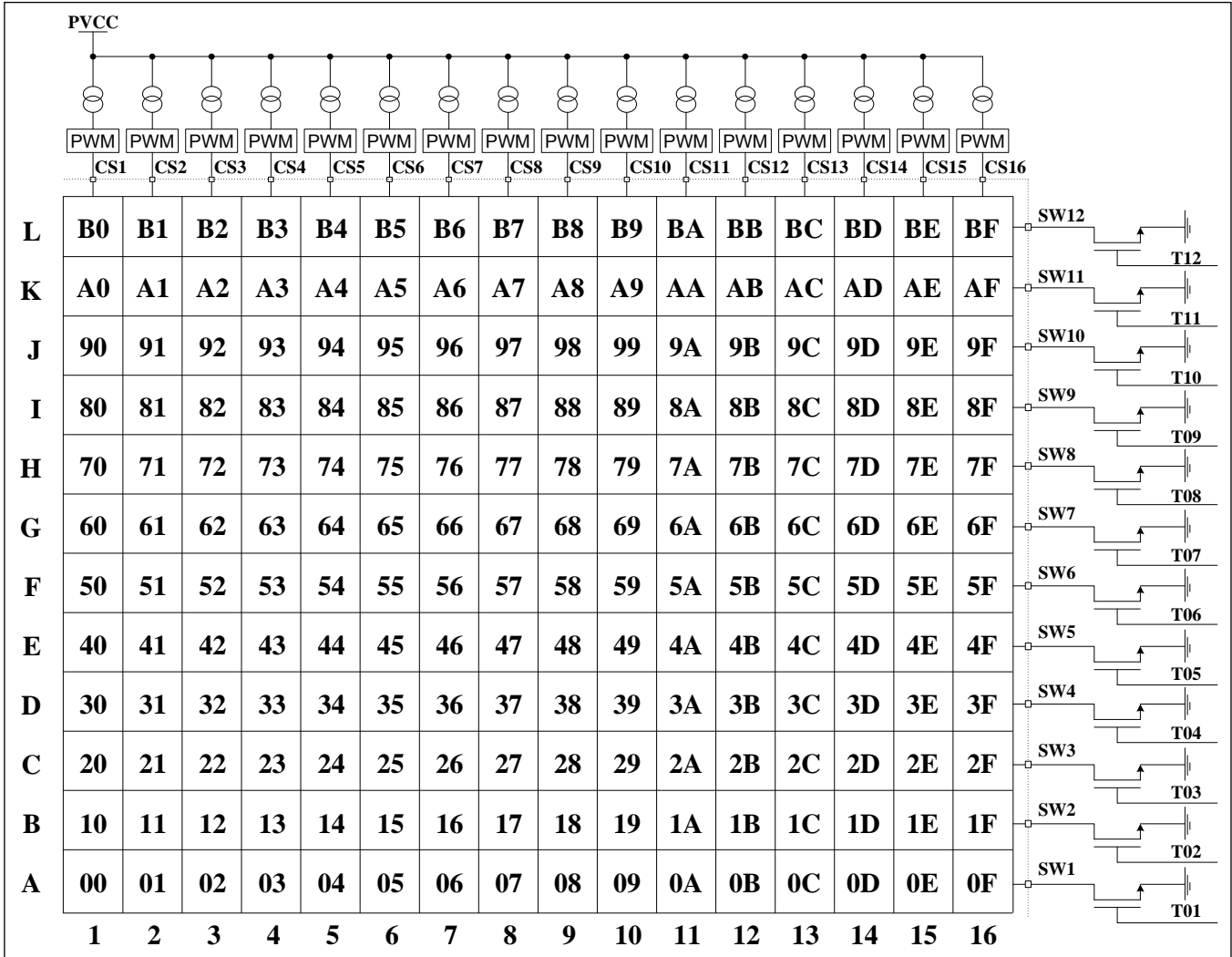

Figure 9 PWM Register

Table 10 00h ~ BFh PWM Register

Bit	D7:D0
Name	PWM
Default	0000 0000

Each dot has a byte to modulate the PWM duty in 256 steps.

The value of the PWM Registers decides the average current of each LED noted  $I_{LED}$ .

$I_{LED}$  computed by Formula (1):

$$I_{LED} = \frac{PWM}{256} \times I_{OUT} \times Duty \quad (1)$$

$$PWM = \sum_{n=0}^7 D[n] \cdot 2^n$$

Where Duty is the duty cycle of SWy,

$$Duty = \frac{128\mu s}{(128\mu s + 8\mu s)} \times \frac{1}{12} = \frac{1}{12.75} \quad (2)$$

$I_{OUT}$  is the output current of CSx (x=1~16),

$$I_{OUT} = \frac{840}{R_{EXT}} \times \frac{GCC}{256} \quad (3)$$

GCC is the Global Current Control register (PG3, 01h) value and  $R_{EXT}$  is the external resistor of  $R_{EXT}$  pin.  $D[n]$  stands for the individual bit value, 1 or 0, in location n.

For example: if D7:D0= 10110101 (0xB5, 181), GCC=255,  $R_{EXT}$ =20kΩ ( $I_{OUT}$ =42mA),

$$I_{LED} = \frac{2^0 + 2^2 + 2^4 + 2^5 + 2^7}{256} \times I_{OUT} \times \frac{1}{12.75} = 2.34mA$$

# IS31FL3733

## Page 2 (PG2, 0x02): Auto Breath Mode Register

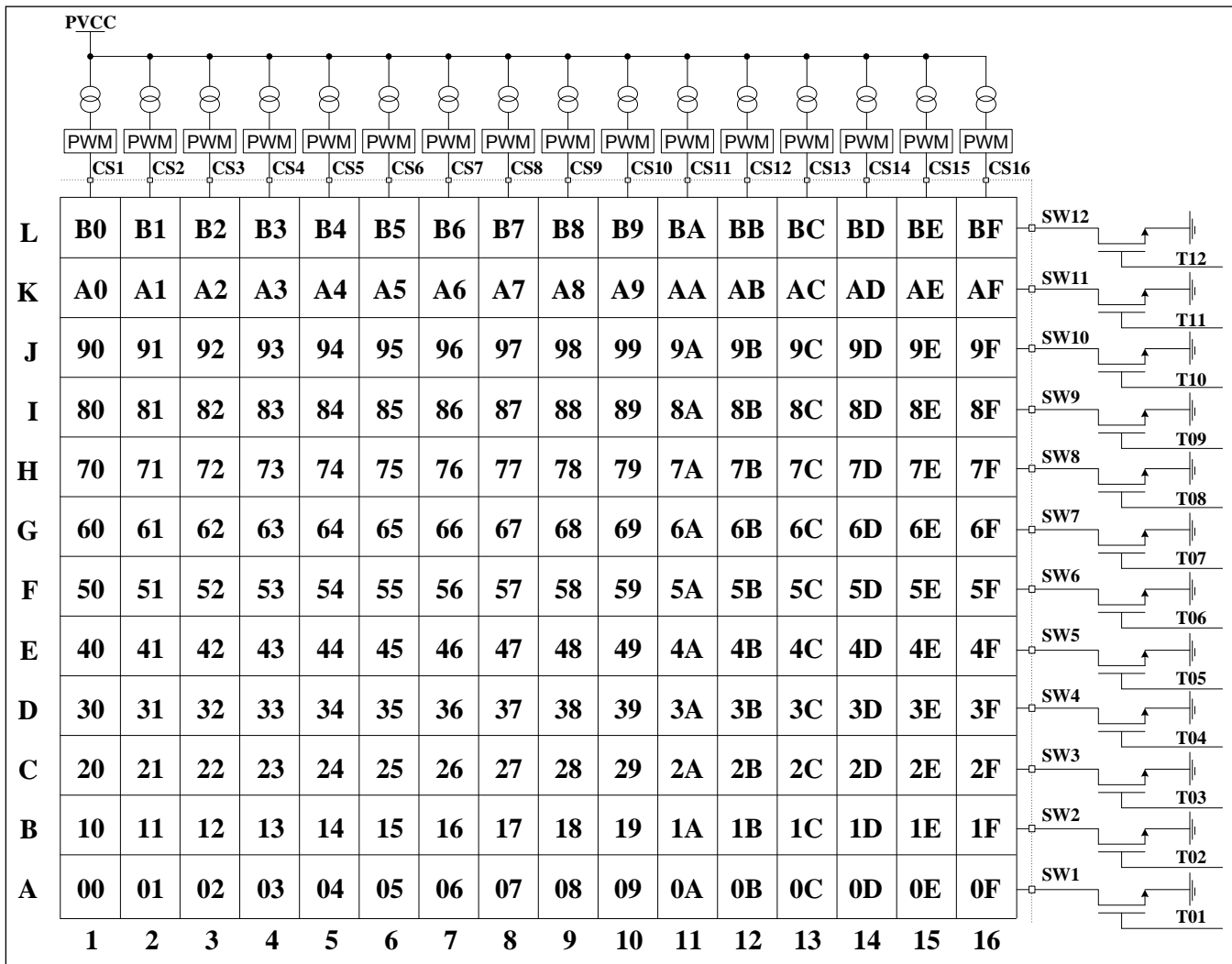

Figure 10 Auto Breath Mode Selection Register

Table 11 00h ~ BFh Auto Breath Mode Register

Bit	D7:D2	D1:D0
Name	-	ABMS
Default	-	00

The Auto Breath Mode Register sets operating mode of each dot.

### ABMS Auto Breath Mode Selection Bit

- 00 PWM control mode
- 01 Select Auto Breath Mode 1 (ABM-1)
- 10 Select Auto Breath Mode 2 (ABM-2)
- 11 Select Auto Breath Mode 3 (ABM-3)



# IS31FL3733

**Table 12 Page 3 (PG3, 0x03): Function Register**

Register	Name	Function	R/W	Default
00h	Configuration Register	Configure the operation mode	W	0000 0000
01h	Global Current Control Register	Set the global current	W	
02h	Auto Breath Control Register 1 of ABM-1	Set fade in and hold time for breath function of ABM-1	W	
03h	Auto Breath Control Register 2 of ABM-1	Set the fade out and off time for breath function of ABM-1	W	
04h	Auto Breath Control Register 3 of ABM-1	Set loop characters of ABM-1	W	
05h	Auto Breath Control Register 4 of ABM-1	Set loop characters of ABM-1	W	
06h	Auto Breath Control Register 1 of ABM-2	Set fade in and hold time for breath function of ABM-2	W	
07h	Auto Breath Control Register 2 of ABM-2	Set the fade out and off time for breath function of ABM-2	W	
08h	Auto Breath Control Register 3 of ABM-2	Set loop characters of ABM-2	W	
09h	Auto Breath Control Register 4 of ABM-2	Set loop characters of ABM-2	W	
0Ah	Auto Breath Control Register 1 of ABM-3	Set fade in and hold time for breath function of ABM-3	W	
0Bh	Auto Breath Control Register 2 of ABM-3	Set the fade out and off time for breath function of ABM-3	W	
0Ch	Auto Breath Control Register 3 of ABM-3	Set loop characters of ABM-3	W	
0Dh	Auto Breath Control Register 4 of ABM-3	Set loop characters of ABM-3	W	
0Eh	Time Update Register	Update the setting of 02h ~ 0Dh registers	W	
0Fh	SWy Pull-Up Resistor Selection Register	Set the pull-up resistor for Swy	W	
10h	CSx Pull-Down Resistor Selection Register	Set the pull-down resistor for CSx	W	
11h	Reset Register	Reset all register to POR state	R	

**Table 13 00h Configuration Register**

Bit	D7:D6	D5:D3	D2	D1	D0
Name	SYNC	-	OSD	B_EN	SSD
Default	00	000	0	0	0

The Configuration Register sets operating mode of IS31FL3733.

When SYNC bits are set to “01”, the IS31FL3733 is configured as the master clock source and the SYNC pin will generate a clock signal distributed to the clock slave devices. To be configured as a clock slave device and accept an external clock input the slave device’s SYNC bits must be set to “10”.

When OSD set high, open/short detection will be trigger once, the user could trigger OS detection again by set OSD from “0” to “1”.

When B\_EN enable, those dots select working in ABM-x mode will start to run the pre-established timing. If it is disabled, all dots work in PWM mode. Following Figure 16 to enable the Auto Breath mode. When SSD is “0”, IS31FL3733 works in software shutdown mode and to normal operate the SSD bit should set to “1”.

# IS31FL3733

<b>SYNC</b>	Synchronize Configuration	011	1.68s
00/11	High Impedance	100	3.36s
01	Master	101	6.72s
10	Slave	110	13.44s
		111	26.88s
<b>OSD</b>	Open/Short Detection Enable Bit		
0	Disable open/short detection	<b>T2</b>	T2 Setting
1	Enable open/short detection	0000	0s
		0001	0.21s
		0010	0.42s
		0011	0.84s
		0100	1.68s
		0101	3.36s
		0110	6.72s
		0111	13.44s
		1000	26.88s
		Others	Unavailable
<b>B_EN</b>	Auto Breath Enable		
0	PWM Mode Enable		
1	Auto Breath Mode Enable		
<b>SSD</b>	Software Shutdown Control		
0	Software shutdown		
1	Normal operation		

**Table 14 01h Global Current Control Register**

Bit	D7:D0
Name	GCCx
Default	0000 0000

The Global Current Control Register modulates all CSx (x=1~16) DC current which is noted as I<sub>OUT</sub> in 256 steps.

I<sub>OUT</sub> is computed by the Formula (3):

$$I_{OUT} = \frac{840}{R_{EXT}} \times \frac{GCC}{256} \quad (3)$$

$$GCC = \sum_{n=0}^7 D[n] \cdot 2^n$$

Where D[n] stands for the individual bit value, 1 or 0, in location n, R<sub>EXT</sub> is the external resistor of R<sub>EXT</sub> pin.

For example: if D7:D0 = 1011 0101,

$$I_{OUT} = \frac{2^0 + 2^2 + 2^4 + 2^5 + 2^7}{256} \times \frac{840}{R_{EXT}}$$

**Table 15 02h, 06h, 0Ah Auto Breath Control Register 1 of ABM-x**

Bit	D7:D5	D4:D1	D0
Name	T1	T2	-
Default	000	0000	0

Auto Breath Control Register 1 set the T1&T2 time in Auto Breath Mode.

<b>T1</b>	T1 Setting
000	0.21s
001	0.42s
010	0.84s

**Table 16 03h, 07h, 0Bh Auto Breath Control Register 2 of ABM-x**

Bit	D7:D5	D4:D1	D0
Name	T3	T4	-
Default	000	0000	0

Auto Breath Control Register 2 set the T3&T4 time in Auto Breath Mode.

<b>T3</b>	T3 Setting
000	0.21s
001	0.42s
010	0.84s
011	1.68s
100	3.36s
101	6.72s
110	13.44s
111	26.88s

<b>T4</b>	T4 Setting
0000	0s
0001	0.21s
0010	0.42s
0011	0.84s
0100	1.68s
0101	3.36s
0110	6.72s
0111	13.44s
1000	26.88s
1001	53.76s
1010	107.52s
Others	Unavailable

# IS31FL3733

**Table 17 04h, 08h, 0Ch Auto Breath Control Register 3 of ABM-x**

Bit	D7:D6	D5:D4	D3:D0
Name	LE	LB	LTA
Default	00	00	0000

Total loop times= LTA ×256 + LTB.

For example, if LTA=2, LTB=100, the total loop times is 256×2+100= 612 times.

For the counting of breathing times, do follow Figure 16 to enable the Auto Breath Mode.

If the loop start from T4,

T4->T1->T2->T3(1)->T4->T1->T2->T3(2)->T4->T1->... and so on.

If the loop not start from T4,

Tx->T3(1) ->T4->T1->T2->T3(2)->T4-> T1->... and so on.

If the loop ends at off state (End of T3), the LED will be off state at last. If the loop ends at on state (End of T1), the LED will run an extra T4&T1, which are not included in loop.

**LB** Loop Beginning Time  
 00 Loop begin from T1  
 01 Loop begin from T2  
 10 Loop begin from T3  
 11 Loop begin from T4

**LE** Loop End Time  
 00 Loop end at off state (End of T3)  
 01 Loop end at on state (End of T1)

**LTA** 8-11 Bits Of Loop Times  
 0000 Endless loop  
 0001 1  
 0010 2  
 ... ...  
 1111 15

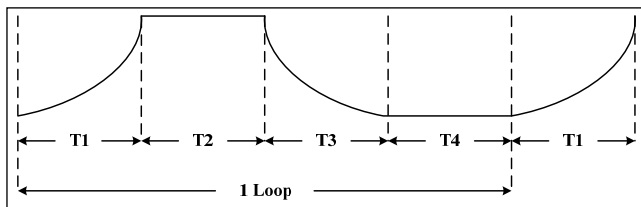

**Figure 11** Auto Breathing Function

**Table 18 05h, 09h, 0Dh Auto Breath Control Register 4 of ABM-x**

Bit	D7:D0
Name	LTB
Default	0000 0000

Total loop times= LTA ×256 + LTB.

For example, if LTA=2, LTB=100, the total loop times is 256×2+100= 612 times.

**LTB** 0-7 Bits Of Loop Times  
 0000 0000 Endless loop  
 0000 0001 1  
 0000 0010 2  
 ... ...  
 1111 1111 255

### 0Eh Time Update Register (02h~0Dh)

The data sent to the time registers (02h~0Dh) will be stored in temporary registers. A write operation of "0000 0000" data to the Time Update Register is required to update the registers (02h~0Dh). Please follow Figure 16 to enable the Auto Breath mode and update the time parameters.

**Table 19 0Fh SWy Pull-Up Resistor Selection Register**

Bit	D7:D3	D2:D0
Name	-	PUR
Default	00000	000

Set pull-up resistor for SWy.

**PUR** SWy Pull-up Resistor Selection Bit  
 000 No pull-up resistor  
 001 0.5kΩ pull-up in t<sub>NOL</sub>  
 010 1.0kΩ pull-up in t<sub>NOL</sub>  
 011 2.0kΩ pull-up in t<sub>NOL</sub>  
 100 4.0kΩ pull-up in t<sub>NOL</sub>  
 101 8.0kΩ pull-up in t<sub>NOL</sub>  
 110 16kΩ pull-up in t<sub>NOL</sub>  
 111 32kΩ pull-up in t<sub>NOL</sub>

# IS31FL3733

**Table 20 10h CSx Pull-Down Resistor Selection Register**

Bit	D7:D3	D2:D0
Name	-	PDR
Default	00000	000

Set the pull-down resistor for CSx.

**PDR** CSx Pull-down Resistor Selection Bit

- 000 No pull-down resistor
- 001 0.5kΩ pull-down in  $t_{NOL}$
- 010 1.0kΩ pull-down in  $t_{NOL}$
- 011 2.0kΩ pull-down in  $t_{NOL}$
- 100 4.0kΩ pull-down in  $t_{NOL}$
- 101 8.0kΩ pull-down in  $t_{NOL}$
- 110 16kΩ pull-down in  $t_{NOL}$
- 111 32kΩ pull-down in  $t_{NOL}$

## 11h Reset Register

Once user read the Reset Register, IS31FL3733 will reset all the IS31FL3733 registers to their default value. On initial power-up, the IS31FL3733 registers are reset to their default values for a blank display.

# IS31FL3733

## APPLICATION INFORMATION

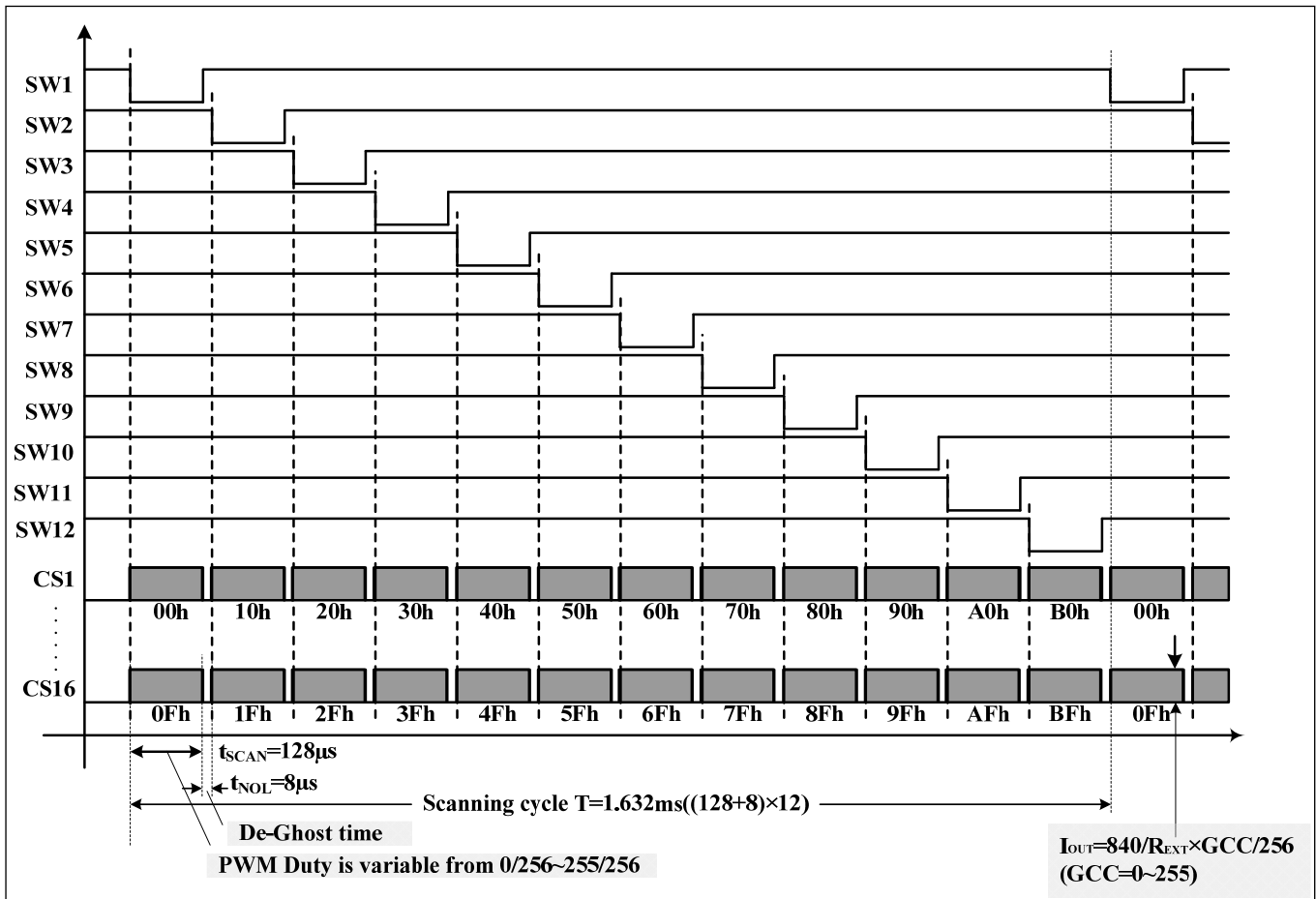

Figure 12 Scanning Timing

### SCANNING TIMING

As shown in Figure 12, the SW1~SW12 is turned on by serial, LED is driven 16 by 16 within the SW<sub>y</sub> (x=1~12) on time (SW<sub>y</sub>, y=1~12) is sink and pull low when LED on), including the non-overlap blanking time during scan, the duty cycle of SW<sub>y</sub> (active low, y=1~12) is:

$$Duty = \frac{128\mu s}{(128\mu s + 8\mu s)} \times \frac{1}{12} = \frac{1}{12.75} \quad (2)$$

Where 128µs is t<sub>SCAN</sub>, the period of scanning and 8µs is t<sub>NOL</sub>, the non-overlap time.

### EXTERNAL RESISTOR (R<sub>EXT</sub>)

The output current for each CS<sub>x</sub> can be set by a single external resistor, R<sub>EXT</sub>, as described in Formula (3).

$$I_{OUT} = \frac{840}{R_{EXT}} \times \frac{GCC}{256} \quad (3)$$

GCC is Global Current Control Register (PG3, 01h) data showing in Table 14.

### PWM CONTROL

After setting the I<sub>OUT</sub> and GCC, the brightness of each LEDs (LED average current (I<sub>LED</sub>)) can be modulated with 256 steps by PWM Register, as described in Formula (1).

$$I_{LED} = \frac{PWM}{256} \times I_{OUT} \times Duty \quad (1)$$

Where PWM is PWM Registers (PG1, 00h~BFh) data showing in Table 10.

For example, in Figure 1, R<sub>EXT</sub> = 20kΩ, if PWM=255, and GCC=255, then

$$I_{LED} = \frac{255}{256} \times \frac{840}{20k\Omega} \times \frac{255}{256} \times \frac{1}{12.75} = 3.29mA$$

Writing new data continuously to the registers can modulate the brightness of the LEDs to achieve a breathing effect.

### LED AVERAGE CURRENT (I<sub>LED</sub>)

As described in Formula (1), the LED average current (I<sub>LED</sub>) is effected by 3 factors:

# IS31FL3733

1.  $R_{EXT}$ , resistor which is connected R\_EXT pin and GND.  $R_{EXT}$  sets the current of all CSx (x=1~16) based on Formula (3).
2. Global Current Control Register (PG3, 01h). This register adjusts all CSx (x=1~16) output currents by 256 steps as shown in Formula (3).
3. PWM Registers (PG1, 00h~BFh), every LED has an own PWM register. PWM Registers adjust individual LED average current by 256 steps as shown in Formula (1).

## GAMMA CORRECTION

In order to perform a better visual LED breathing effect we recommend using a gamma corrected PWM value to set the LED intensity. This results in a reduced number of steps for the LED intensity setting, but causes the change in intensity to appear more linear to the human eye.

Gamma correction, also known as gamma compression or encoding, is used to encode linear luminance to match the non-linear characteristics of display. Since the IS31FL3733 can modulate the brightness of the LEDs with 256 steps, a gamma correction function can be applied when computing each subsequent LED intensity setting such that the changes in brightness matches the human eye's brightness curve.

**Table 21 32 Gamma Steps with 256 PWM Steps**

C(0)	C(1)	C(2)	C(3)	C(4)	C(5)	C(6)	C(7)
0	1	2	4	6	10	13	18
C(8)	C(9)	C(10)	C(11)	C(12)	C(13)	C(14)	C(15)
22	28	33	39	46	53	61	69
C(16)	C(17)	C(18)	C(19)	C(20)	C(21)	C(22)	C(23)
78	86	96	106	116	126	138	149
C(24)	C(25)	C(26)	C(27)	C(28)	C(29)	C(30)	C(31)
161	173	186	199	212	226	240	255

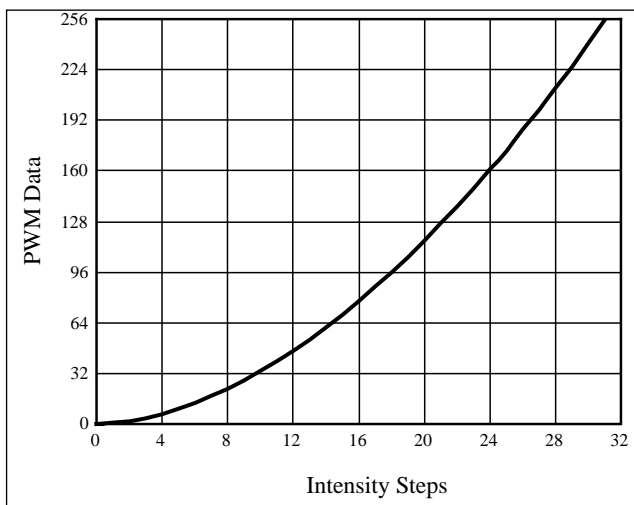
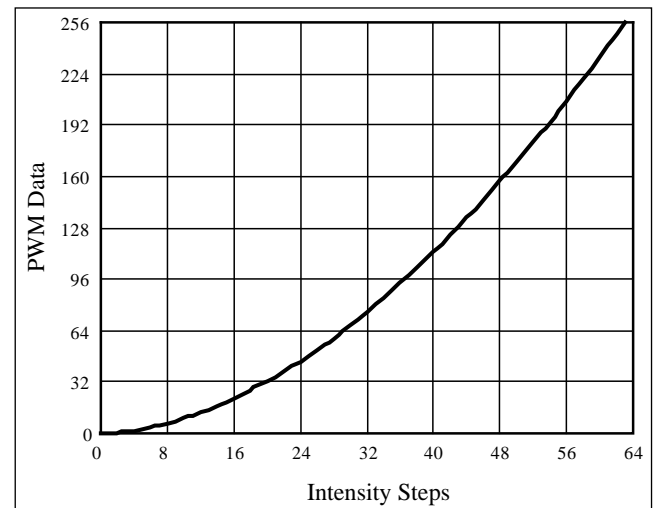

**Figure 13** Gamma Correction (32 Steps)

Choosing more gamma steps provides for a more continuous looking breathing effect. This is useful for very long breathing cycles. The recommended configuration is defined by the breath cycle T. When T=1s, choose 32 gamma steps, when T=2s, choose 64 gamma steps. The user must decide the final number of gamma steps not only by the LED itself, but also based on the visual performance of the finished product.

**Table 22 64 Gamma Steps with 256 PWM Steps**

C(0)	C(1)	C(2)	C(3)	C(4)	C(5)	C(6)	C(7)
0	1	2	3	4	5	6	7
C(8)	C(9)	C(10)	C(11)	C(12)	C(13)	C(14)	C(15)
8	10	12	14	16	18	20	22
C(16)	C(17)	C(18)	C(19)	C(20)	C(21)	C(22)	C(23)
24	26	29	32	35	38	41	44
C(24)	C(25)	C(26)	C(27)	C(28)	C(29)	C(30)	C(31)
47	50	53	57	61	65	69	73
C(32)	C(33)	C(34)	C(35)	C(36)	C(37)	C(38)	C(39)
77	81	85	89	94	99	104	109
C(40)	C(41)	C(42)	C(43)	C(44)	C(45)	C(46)	C(47)
114	119	124	129	134	140	146	152
C(48)	C(49)	C(50)	C(51)	C(52)	C(53)	C(54)	C(55)
158	164	170	176	182	188	195	202
C(56)	C(57)	C(58)	C(59)	C(60)	C(61)	C(62)	C(63)
209	216	223	230	237	244	251	255



**Figure 14** Gamma Correction (64 Steps)

**Note:** The data of 32 gamma steps is the standard value and the data of 64 gamma steps is the recommended value.

## OPERATING MODE

Each dot of IS31FL3733 has two selectable operating modes, PWM Mode and Auto Breath Mode.

### PWM Mode

By setting the Auto Breath Mode Register bits of the Page 2 (PG2, 00h~BFh) to "00", or disable the B\_EN bit of Configure Register (PG3, 00h), the IS31FL3733

# IS31FL3733

operates in PWM Mode. The brightness of each LED can be modulated with 256 steps by PWM registers. For example, if the data in PWM Register is “0000 0100”, then the PWM is the fourth step.

Writing new data continuously to the registers can modulate the brightness of the LEDs to achieve a breathing effect.

## Auto Breath Mode

By setting the B\_EN bit of the Configuration Register (PG3, 00h) to “1”, breath function enables. When set the B\_EN bit to “0”, breath function disables.

By setting the Auto Breath Mode Register bits of the Page 2 (PG2, 00h~BFh) to “01” (ABM-1), “10” (ABM-2) or “11” (ABM-3), the IS31FL3733 operates in Auto Breath Mode.

IS31FL3733 has three auto breath modes, Auto Breath Mode 1, Auto Breath Mode 2 and Auto Breath Mode 3. Each ABM has T1, T2, T3 and T4, as shown below:

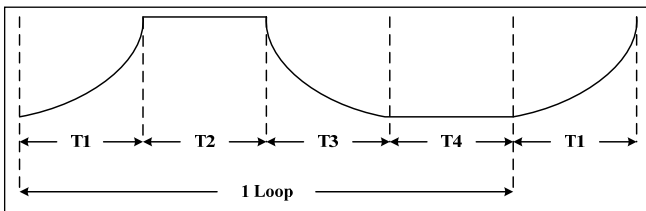

Figure 15 Auto Breathing Function

T1/T3 is variable from 0.21s to 26.88s, T2/T4 is variable from 0s to 26.88s, for each loop, the start point can be T1~T4 and the stop point can be on state (T2) and off state (T4), also the loop time can be set to 1~2<sup>12</sup> times or endless. Each LED can select ABM-1~ABM-3 to work.

The setting of ABM-1~ABM-3 (PG2, 02h~0Dh) need to write the 0Eh in PG3 to update before effective.

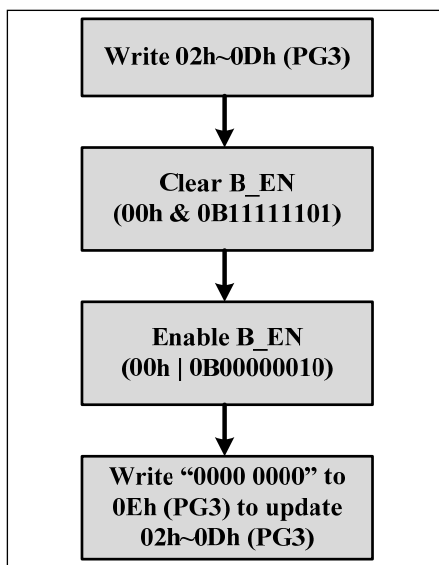

Figure 16 Enable Auto Breath Mode

If not follow this flow, first loop’s start point may be wrong.

## OPEN/SHORT DETECT FUNCTION

IS31FL3733 has open and short detect bit for each LED.

By setting the OSD bit of the Configuration Register (PG3, 00h) from “0” to “1”, the LED Open Register and LED Short Register will start to store the open/short information and after at least 2 scanning cycle (3.264ms) the MCU can get the open/short information by reading the 18h~2Fh/30h~47h, for those dots are turned off via LED On/Off Registers (PG0, 00h~17h), the open/short data will not get refreshed when setting the OSD bit of the Configuration Register (PG3, 00h) from “0” to “1”.

The Global Current Control Register (PG3, 01h) need to set to 0x01 in order to get the right open/short data.

The detect action is one-off event and each time before reading out the open/short information, the OSD bit of the Configuration Register (PG3, 00h) need to be set from “0” to “1” (clear before set operation).

## INTERRUPT CONTROL

IS31FL3733 has an INTB pin, by setting the Interrupt Mask Register (F0h), it can be the flag of LED open, LED short or the finish flag of ABM-1, ABM-2, and ABM-3.

For example, if the IO bit of the Interrupt Mask Register (F0h) set to “1”, when LED open happens, the INTB will pull be pulled low and the OB bit of Interrupt Status Register (F1h) will store open status at the same time.

The INTB pin will be pulled high after reading the Interrupt Status Register (F1h) operation or it will be pulled high automatically after it stays low for 8ms (Typ.) if the IAC bit of Interrupt Mask Register (F0h) is set to “1”. The bits of Interrupt Status Register (F1h) will be reset to “0” after INTB pin pulled high.

## SYNCHRONIZE FUNCTION

SYNC bits of the Configuration Register (PG3, 00h) sets SYNC pin input or output synchronize clock signal. It is used for more than one part working synchronize. When SYNC bits are set to “01”, SYNC pin output synchronize clock to synchronize other parts as master. When SYNC bits are set to “10”, SYNC pin input synchronize clock and work synchronization with this input signal as slave. When SYNC bits are set to “00/11”, SYNC pin is high impedance, and synchronize function is disabled. SYNC bit default state is “00” and SYNC pin is high impedance when power up.

## DE-GHOST FUNCTION

The “ghost” term is used to describe the behavior of an LED that should be OFF but instead glows dimly when another LED is turned ON. A ghosting effect typically can occur when multiplexing LEDs. In matrix

# IS31FL3733

architecture any parasitic capacitance found in the constant-current outputs or the PCB traces to the LEDs may provide sufficient current to dimly light an LED to create a ghosting effect.

To prevent this LED ghost effect, the IS31FL3733 has integrated pull-up resistors for each SW<sub>y</sub> (y=1~12) and pull-down resistors for each CS<sub>x</sub> (x=1~16). Select the right SW<sub>y</sub> pull-up resistor (PG3, 0Fh) and CS<sub>x</sub> pull-down resistor (PG3, 10h) which eliminates the ghost LED for a particular matrix layout configuration.

Typically, selecting the 32kΩ will be sufficient to eliminate the LED ghost phenomenon.

The SW<sub>y</sub> pull-up resistors and CS<sub>x</sub> pull-down resistors are active only when the CS<sub>x</sub>/SW<sub>y</sub> outputs are in the OFF state and therefore no power is lost through these resistors

## I2C RESET

The I2C will be reset if the IICRST pin is pull-high, when normal operating the I2C bus, the IICRST pin need to keep low.

## SHUTDOWN MODE

Shutdown mode can be used as a means of reducing power consumption. During shutdown mode all registers retain their data.

### Software Shutdown

By setting SSD bit of the Configuration Register (PG3, 00h) to “0”, the IS31FL3733 will operate in software shutdown mode. When the IS31FL3733 is in software shutdown, all current sources are switched off, so that the matrix is blanked. All registers can be operated. Typical current consume is 3μA.

### Hardware Shutdown

The chip enters hardware shutdown when the SDB pin is pulled low. All analog circuits are disabled during hardware shutdown, typical the current consume is 3μA.

The chip releases hardware shutdown when the SDB pin is pulled high. During hardware shutdown state Function Register can be operated.

If V<sub>CC</sub> has risk drop below 1.75V but above 0.1V during SDB pulled low, please re-initialize all Function Registers before SDB pulled high.

## TEST MODE

In order to test or adjust some items of the IC, the IS31FL3733 has some registers in test mode. In test mode, the scanning of the SW can be stopped and some parameters can be adjusted by setting the register bits of certain registers. Test mode is not allowed to enter in normal operations, but in some bad conditions like keep doing EFT (Electrical Fast Transient) test in power system, very low risk that the I2C bus will mis-write those registers and let the IC

stop scanning, and keep working in test mode. So we recommend for white goods applications, writing these registers repeatedly like every 5 seconds to prevent the IC entering test mode without quitting.

1. Write FDh with 0x03 enter page 3, if it is in page 3, skip this step.
2. Write E0h with 0x01 to enter test mode
3. Write E1h with 0x00 to quit the ‘SW<sub>y</sub> stop scanning’ status.
4. Write E2h with 0x00 to default value
5. Write E3h with 0x00 to default value
6. Write E0h with 0x01 to quit and prevent entering test mode.

Below are definition of test related registers.

**Table 21 E0h Test Mode Enable Register**

Bit	D7:D1	D0
Name	-	TEST_PT
Default	0000 000	0

Test mode enable register has two functions, first it is the entrance of the test mode, second it also protect the other test registers been miswritten.

<b>TEST_PT</b>	Test mode protect bit
0	Disable test mode, E1h~E3h cannot be accessed
1	Enable test mode, E1h~E3h can be accessed

**Table 22 E1h Test Mode Data Register 1**

Bit	D7:D4	D3:D0
Name	-	SW_S
Default	0000	0000

When normal operation, SW1~SW12 are always scanning as the timing of Figure 12, if SW\_S bits are set to “0001”~“0111”, SW<sub>y</sub> stop scanning’ status and one of the SW<sub>y</sub> will be selected as the power output all the time.

<b>SW_S</b>	SW <sub>y</sub> Setting
0001	SW1 always on, other SW <sub>y</sub> float
0010	SW2 always on, other SW <sub>y</sub> float
0011	SW3 always on, other SW <sub>y</sub> float
0100	SW4 always on, other SW <sub>y</sub> float
0101	SW5 always on, other SW <sub>y</sub> float
0110	SW6 always on, other SW <sub>y</sub> float
0111	SW7 always on, other SW <sub>y</sub> float
1000	SW8 always on, other SW <sub>y</sub> float
1001	SW9 always on, other SW <sub>y</sub> float
1010	SW10 always on, other SW <sub>y</sub> float
1011	SW11 always on, other SW <sub>y</sub> float
1100	SW12 always on, other SW <sub>y</sub> float



# IS31FL3733

**Table 23 E2h Test Mode Data Register 2**

Bit	D7:D3	D2:D0
Name	-	TRIM_CS
Default	00	000

**Table 24 E3h Test Mode Data Register 3**

Bit	D7:D4	D3:D0
Name	TRIM_BG	TRIM_OSC
Default	0000	0000

Data register 2 and 3 can change the voltage of R\_EXT pin (TRIM\_BG), adjust the internal oscillator frequency (TRIM\_OSC) and trim the average output current of all CSx (TRIM\_CS), when normal operation, these registers must keep default value, otherwise those parameters will be changed permanently.

## POWER DISSIPATION

The power dissipation of the IS31FL3733 can calculate as below:

$$\begin{aligned}
 P_{3733} &= I_{PVCC} \times PV_{CC} + I_Q \times DV_{CC}(AV_{CC}) - I_{PVCC} \times V_{F(AVR)} \\
 &\approx I_{PVCC} \times PV_{CC} - I_{PVCC} \times V_{F(AVR)} \\
 &\approx I_{PVCC} \times (PV_{CC} - V_{F(AVR)})
 \end{aligned}
 \tag{4}$$

Where  $I_{PVCC}$  is the current of PVCC and  $V_{F(AVR)}$  is the average forward of all the LED.

For example, if  $R_{EXT}=20k\Omega$ ,  $GCC=255$ ,  $PWM=255$ ,  $PV_{CC}=5V$ ,  $V_{F(AVR)}=3.5V@42mA$ ,

then the  $I_{PVCC}=42mA \times 16 \times 12/12.75=632.5mA$ .

$$P_{3733}=632.5mA \times (5V-3.5V)=0.948.75W$$

When operating the chip at high ambient temperatures, or when driving maximum load current, care must be taken to avoid exceeding the package power dissipation limits. The maximum power dissipation can be calculated using the following Equation (5):

$$P_{D(MAX)} = \frac{125^{\circ}C - 25^{\circ}C}{\theta_{JA}} \tag{5}$$

$$\text{So, } P_{D(MAX)} = \frac{125^{\circ}C - 25^{\circ}C}{39^{\circ}C/W} \approx 2.56W (eTQFP)$$

$$\text{And, } P_{D(MAX)} = \frac{125^{\circ}C - 25^{\circ}C}{37.5^{\circ}C/W} \approx 2.67W (QFN)$$

Figure 17 and 18, shows the power derating of the IS31FL3733 on a JEDEC boards (in accordance with JESD 51-5 and JESD 51-7) standing in still air.

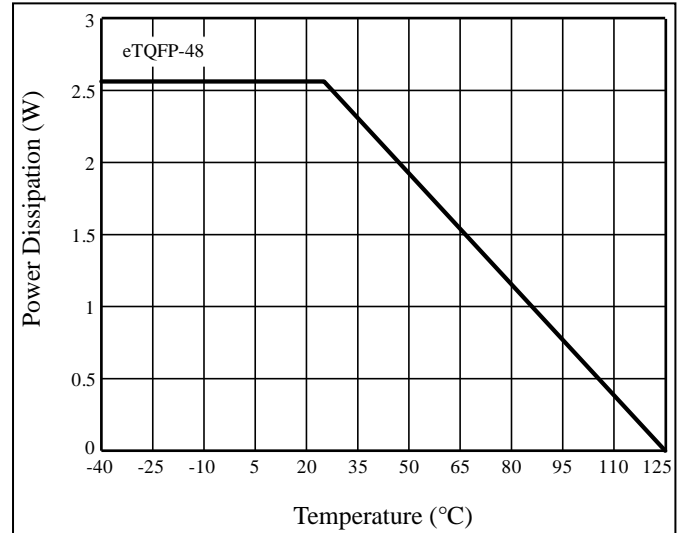

**Figure 17** Dissipation Curve

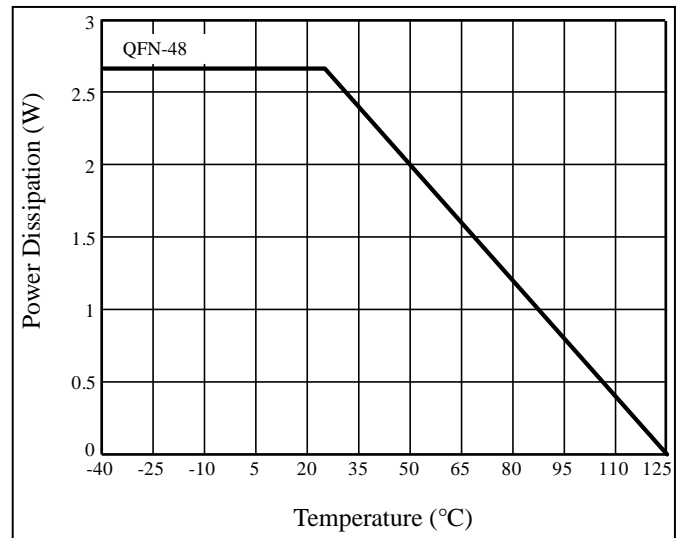

**Figure 18** Dissipation Curve

## LAYOUT

As described in external resistor ( $R_{EXT}$ ), the chip consumes lots of power. Please consider below factors when layout the PCB.

1. The  $V_{CC}$  (PVCC, DVCC, AVCC, VIO) capacitors need to close to the chip and the ground side should well connected to the GND of the chip.
2.  $R_{EXT}$  should be close to the chip and the ground side should well connect to the GND of the chip.
3. The thermal pad should connect to ground pins and the PCB should have the thermal pad too, usually this pad should have 16 or 25 via thru the PCB to other side's ground area to help radiate the heat. About the thermal pad size, please refer to the land pattern of each package.
4. The CSx pins maximum current is 42mA ( $R_{EXT}=20k\Omega$ ), and the SWy pins maximum current is 672mA ( $R_{EXT}=20k\Omega$ ), the width of the trace, SWy should have wider trace than CSx.

## IS31FL3733

---

5. In the middle of SDA and SCL trace, a ground line is recommended to avoid the effect between these two lines.

# IS31FL3733

## CLASSIFICATION REFLOW PROFILES

Profile Feature	Pb-Free Assembly
<b>Preheat &amp; Soak</b> Temperature min (T <sub>smin</sub> ) Temperature max (T <sub>smax</sub> ) Time (T <sub>smin</sub> to T <sub>smax</sub> ) (t <sub>s</sub> )	150°C 200°C 60-120 seconds
Average ramp-up rate (T <sub>smax</sub> to T <sub>p</sub> )	3°C/second max.
Liquidous temperature (T <sub>L</sub> ) Time at liquidous (t <sub>L</sub> )	217°C 60-150 seconds
Peak package body temperature (T <sub>p</sub> )*	Max 260°C
Time (t <sub>p</sub> )** within 5°C of the specified classification temperature (T <sub>c</sub> )	Max 30 seconds
Average ramp-down rate (T <sub>p</sub> to T <sub>smax</sub> )	6°C/second max.
Time 25°C to peak temperature	8 minutes max.

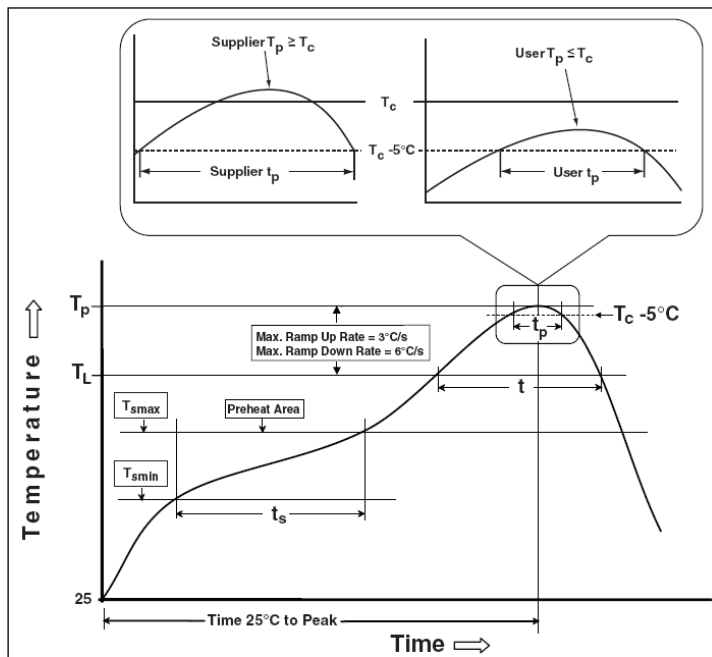
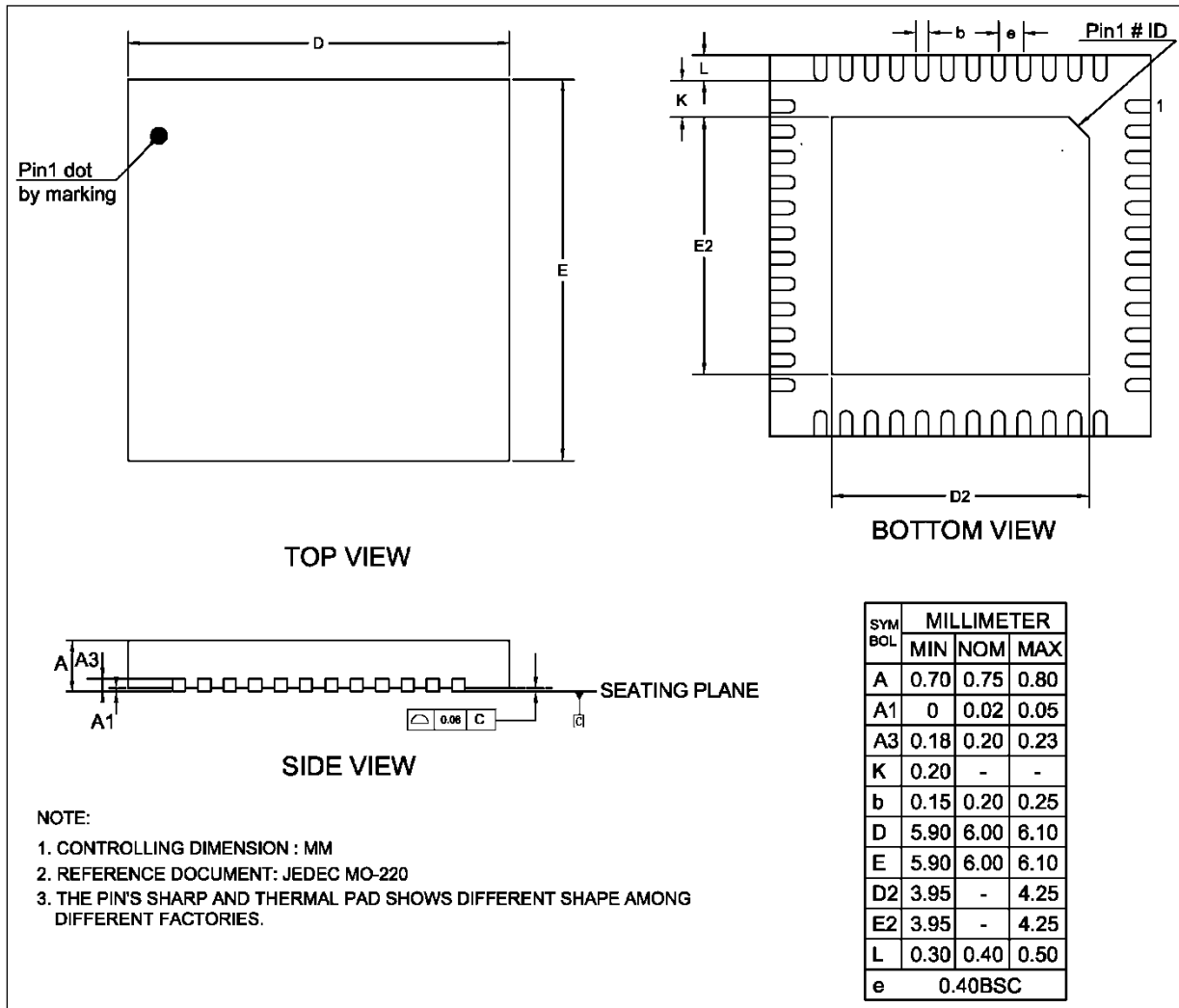

Figure 19 Classification Profile

# IS31FL3733

## PACKAGE INFORMATION

### QFN-48



# IS31FL3733

eTQFP-48

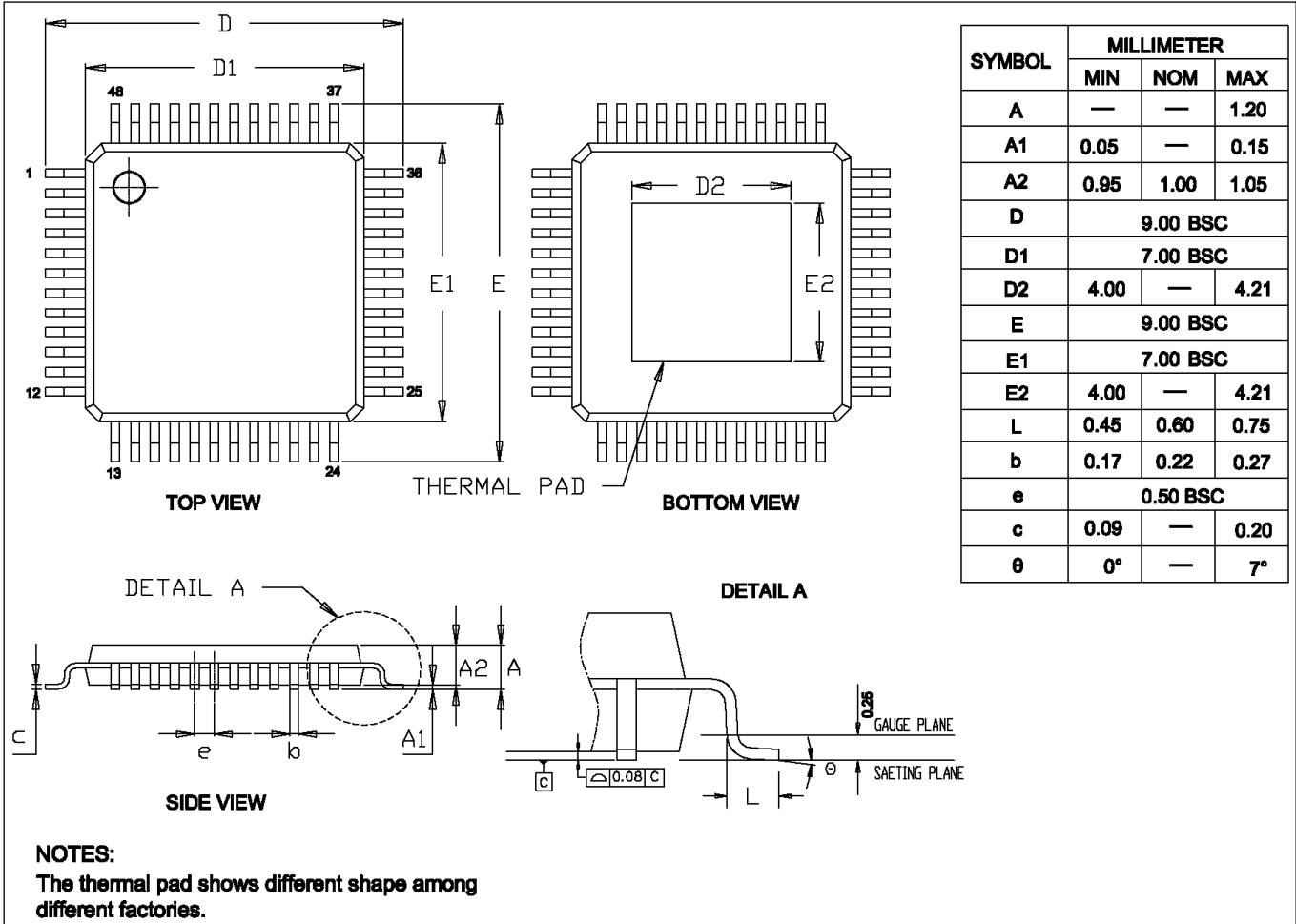

# IS31FL3733

## RECOMMENDED LAND PATTERN

### QFN-48

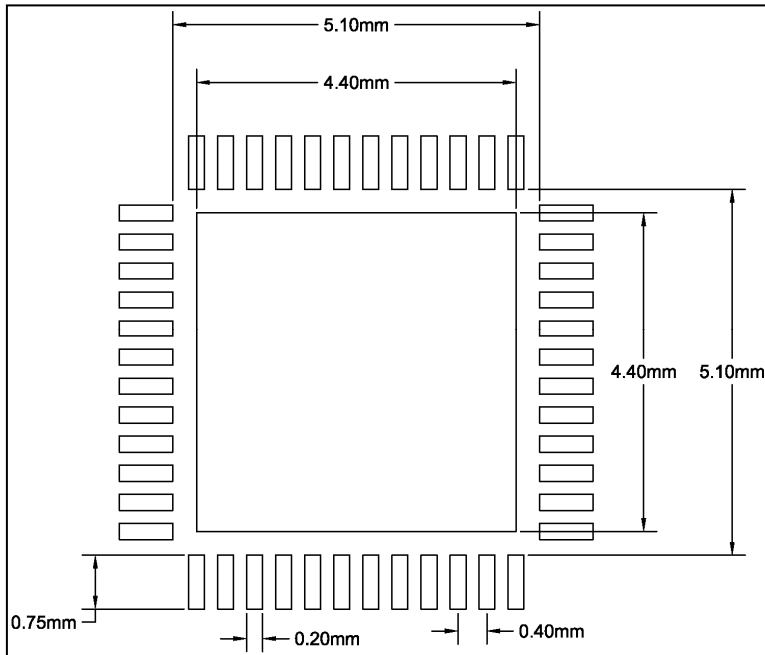

### eTQFP-48

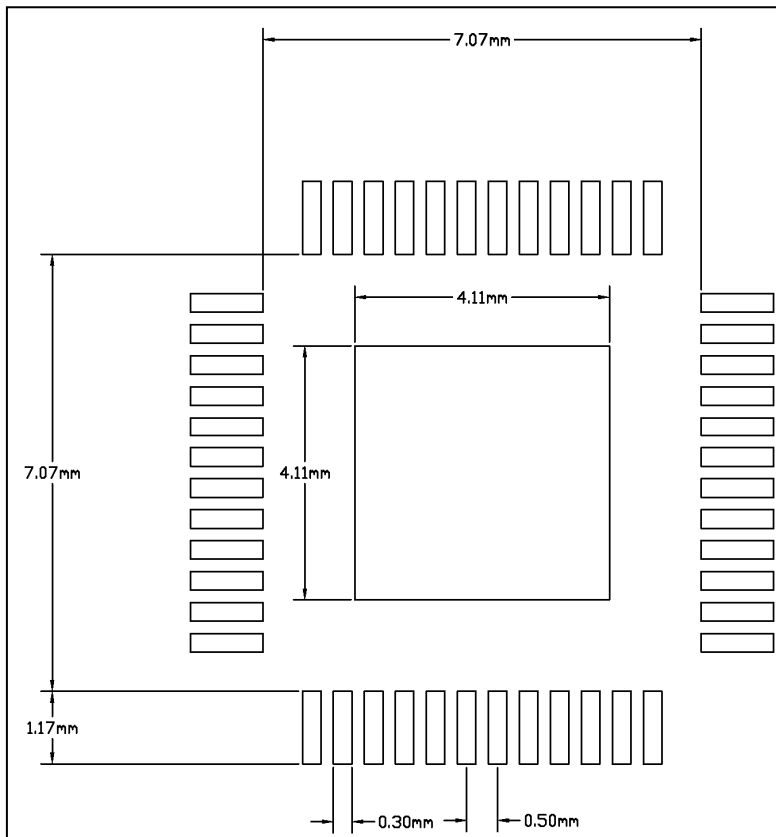

**Note:**

1. Land pattern complies to IPC-7351.
2. All dimensions in MM.
3. This document (including dimensions, notes & specs) is a recommendation based on typical circuit board manufacturing parameters. Since land pattern design depends on many factors unknown (eg. User's board manufacturing specs), user must determine suitability for use.

## REVISION HISTORY

Revision	Detail Information	Date
A	Initial release	2016.07.01
B	1. Update READING OPERATION 2. Correct error of REGISTER DEFINITION-2 3. Update Figure 8	2016.12.20
C	1. Correct REGISTER DEFINITION-2 and Table 2 2. Update land pattern 3. Add ICC and $V_{HR}$ at GCC=0x12	2018.09.25
D	Add Test Mode section in APPLICATION INFORMATION	2018.12.17