

**4T4R Direct RF Receiver and Transmitter****FEATURES**

- ▶ Flexible, reconfigurable radio common platform design
  - ▶ Transmitter/receiver channel bandwidth up to 1.2 GHz (4T4R)
  - ▶ RF DAC/RF ADC RF frequency range up to 7.5 GHz
  - ▶ On-chip PLL with multichip synchronization
    - ▶ External RF clock input option
- ▶ Versatile digital features
  - ▶ Selectable interpolation and decimation filters
  - ▶ Configurable DDCs and DUCs
    - ▶ 8 fine complex DUCs (FDUC) and 4 coarse complex DUCs (CDUC)
    - ▶ 8 fine complex DDCs (FDDC) and 4 coarse complex DDCs (CDDC)
    - ▶ FDUCs and FDDCs are fully bypassable
    - ▶ 2 independent 48-bit NCOs per DUC or DDC
  - ▶ Programmable 192-tap PFIR filter for receive equalization
    - ▶ Supports 4 different profile settings loaded via GPIO
  - ▶ Receive AGC support
    - ▶ Fast detect with low latency for fast AGC control
    - ▶ Signal monitor for slow AGC control
    - ▶ Dedicated AGC support pins
  - ▶ Transmit DPD support
    - ▶ Programmable delay and gain per transmit data path
    - ▶ Coarse DDC delay adjust for DPD observation path
  - ▶ Supports real or complex digital data (8-, 12-, or 16-bit)
- ▶ Auxiliary features
  - ▶ ADC clock driver with selectable divide ratios
  - ▶ Power amplifier downstream protection circuitry
  - ▶ On-chip temperature monitoring unit
  - ▶ Programmable GPIO pins support toggling between modes
  - ▶ TDD power savings option and sharing ADCs
- ▶ SERDES JESD204B or JESD204C interface, 16 lanes up to 24.75 Gbps
  - ▶ 8 lanes JESD204B/C transmitter (JT<sub>x</sub>) and 8 lanes JESD204B/C receiver (JR<sub>x</sub>)
  - ▶ Supports Subclass 1
- ▶ Supports multidevice synchronization
- ▶ 15 mm × 15 mm, 324-ball BGA with 0.8 mm pitch

**APPLICATIONS**

- ▶ Wireless communications infrastructure
- ▶ W-CDMA, LTE, LTE-A, massive multiple input multiple output (MIMO)
- ▶ Point to point microwave, E-band, and 5G mmWave
- ▶ Broadband communications systems
- ▶ DOCSIS 3.0+ cable modem termination system (CMTS)
- ▶ Communication test and measurement systems

**GENERAL DESCRIPTION**

The **AD9988** is a highly integrated device with four 16-bit, 12 GSPS maximum sample rate, RF digital-to-analog converter (DAC) cores, and four 12-bit, 4 GSPS rate, RF analog-to-digital converter (ADC) cores. The device supports four transmitter channels and four receiver channels with a 4T4R configuration. This product is well suited for four-antenna TDD transmitter applications, where the receiver path can be shared between receiver and observation modes. The GPIO pins can be configured and toggled to support different user modes, while phase coherency is maintained. The maximum radio channel bandwidth supported is 1.2 GHz in a 4T4R configuration and a sample resolution of 16 bits. The AD9988 features a 16-lane 24.75 Gbps JESD204C or 15.5 Gbps JESD204B serial data port that allows up to eight lanes per transmit/receive link, an on-chip clock multiplier, and digital signal processing capability targeted at multiband direct to RF radio applications.

**TABLE OF CONTENTS**

Features.....	1	CMOS Pin Specifications.....	14
Applications.....	1	DAC AC Specifications.....	14
General Description.....	1	ADC AC Specifications.....	16
Functional Block Diagram.....	3	Timing Specifications.....	18
Specifications.....	4	Absolute Maximum Ratings.....	20
Recommended Operating Conditions.....	4	Thermal Resistance.....	20
Power Consumption.....	4	ESD Caution.....	20
DAC DC Specifications.....	5	Pin Configuration and Function Descriptions.....	21
ADC DC Specifications.....	6	Typical Performance Characteristics.....	26
Clock Inputs and Outputs.....	7	DAC.....	26
Clock Input and Phase-Locked Loop (PLL)		ADC.....	31
Frequency Specifications.....	7	Theory of Operation.....	38
DAC Sample Rate Specifications.....	7	Applications Information.....	39
ADC Sample Rate Specifications.....	9	Outline Dimensions.....	40
Input Data Rates Specifications.....	10	Ordering Guide.....	40
NCO Frequency Specifications.....	11	Evaluation Boards.....	40
JESD204B and JESD204C Interface			
Electrical and Speed Specifications.....	11		

**REVISION HISTORY****7/2021—Rev. 0 to Rev. A**

Changes to Table 20 .....	20
---------------------------	----

**3/2021—Revision 0: Initial Version**

FUNCTIONAL BLOCK DIAGRAM

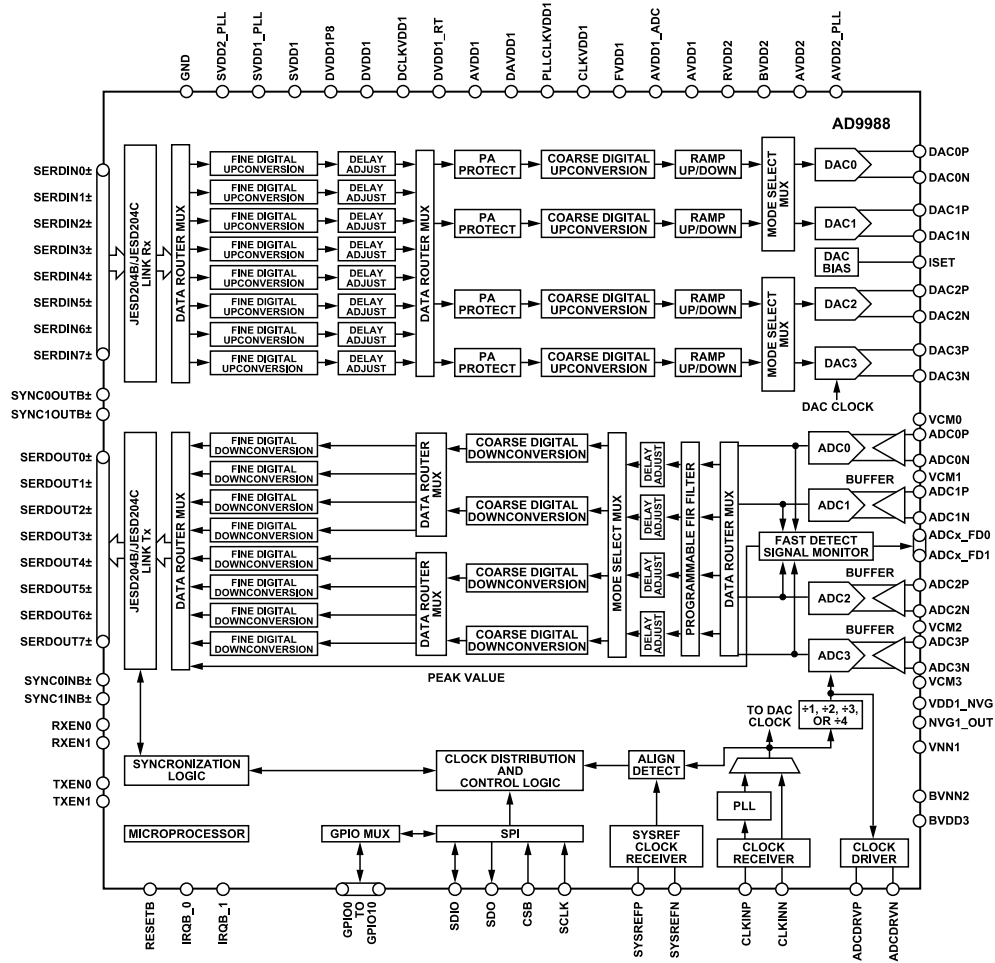

Figure 1.

001

## SPECIFICATIONS

## RECOMMENDED OPERATING CONDITIONS

Successful DAC calibration is required during the device initialization phase that occurs shortly after power-up to ensure long-term reliability of the DAC core circuitry. Refer to [UG-1578](#), the device user guide, for more information on device initialization.

Table 1.

Parameter	Min	Typ	Max	Unit
OPERATING JUNCTION TEMPERATURE (T <sub>J</sub> )	-40		+120	°C
ANALOG SUPPLY VOLTAGE RANGE				
AVDD2, BVDD2, RVDD2	1.9	2.0	2.1	V
AVDD1, AVDD1_ADC, CLKVDD1, FVDD1, VDD1_NVG1	0.95	1.0	1.05	V
DIGITAL SUPPLY VOLTAGE RANGE				
DVDD1, DVDD1_RT, DCLKVDD1, DAVDD1	0.95	1.0	1.05	V
DVDD1P8	1.7	1.8	2.1	V
SERIALIZER/DESERIALIZER (SERDES) SUPPLY VOLTAGE RANGE				
SVDD2_PLL	1.9	2.0	2.1	V
SVDD1, SVDD1_PLL	0.95	1.0	1.05	V

## POWER CONSUMPTION

Typical at nominal supplies and maximum at 5% supplies. For the minimum and maximum values, T<sub>J</sub> varies between -40°C and +120°C. For the typical values, T<sub>A</sub> = 25°C, which corresponds to T<sub>J</sub> = 80°C, unless otherwise noted.

DAC datapath with a complex I/Q data rate frequency (f<sub>IQ\_DATA</sub>) = 1500 MSPS, interpolation of 8×, and DAC frequency (f<sub>DAC</sub>) of 12 GSPS. JRx mode of 15C (L = 8, M = 8, F = 2, S = 1, K = 128, E = 1, N = 16, NP = 16).

ADC datapath with a complex f<sub>IQ\_DATA</sub> = 1500 MSPS, decimation of 2×, and f<sub>ADC</sub> of 3 GSPS. JT<sub>x</sub> mode of 16C (L = 8, M = 8, F = 2, S = 1, K = 128, E = 1, N = 16, NP = 16).

Note that the AD9988 does not support the option to bypass the CDUC in the transmit data path and the CDDC in the receive data path.

See the [UG-1578](#) user guide for further information on the JESD204B and JESD204C mode configurations, and a detailed description of the settings referenced throughout this data sheet. A table showing other operational modes and the corresponding typical and maximum power consumption numbers is included.

Table 2.

Parameter	Test Conditions/Comments	Min	Typ	Max	Unit
CURRENTS					
AVDD2 (I <sub>AVDD2</sub> )	2.0 V supply		190	205	mA
BVDD2 (I <sub>BVDD2</sub> ) + RVDD2 (I <sub>RVDD2</sub> )	2.0 V supply		295	350	mA
AVDD2_PLL (I <sub>AVDD2_PLL</sub> ) + SVDD2_PLL (I <sub>SVDD2_PLL</sub> )	2.0 V supply		45	55	mA
Power Dissipation for 2 V Supplies	2.0 V supply total power dissipation		1.06	1.22	W
PLLCLKVDD1 (I <sub>PLLCLKVDD1</sub> )	1.0 V supply		15	25	mA
AVDD1 (I <sub>AVDD1</sub> ) + DCLKVDD1 (I <sub>DCLKVDD1</sub> )	1.0 V supply		1000	1185	mA
AVDD1_ADC (I <sub>AVDD1_ADC</sub> )	1.0 V supply		1620	1900	mA
CLKVDD1 (I <sub>CLKVDD1</sub> )	1.0 V supply		60	110	mA
FVDD1 (I <sub>FVDD1</sub> )	1.0 V supply		45	65	mA
VDD1_NVG (I <sub>VDD1_NVG</sub> )	1.0 V supply		280	345	mA
DAVDD1 (I <sub>DAVDD1</sub> )	1.0 V supply		1590	1835	mA
DVDD1 (I <sub>DVDD1</sub> )	1.0 V supply		2780	3805	mA
DVDD1_RT (I <sub>DVDD1_RT</sub> )	1.0 V supply		565	690	mA
SVDD1 (I <sub>SVDD1</sub> ) + SVDD1_PLL (I <sub>SVDD1_PLL</sub> )	1.0 V supply		1920	2570	mA
Power Dissipation for 1 V Supplies	1.0 V supply total power dissipation		9.88	12.53	W

## SPECIFICATIONS

Table 2.

Parameter	Test Conditions/Comments	Min	Typ	Max	Unit
DVDD1P8 ( $I_{DVDD1P8}$ )	1.8 V supply		7	10	mA
Total Power Dissipation	Total power dissipation of 2 V and 1 V supplies		10.95	13.77	W

## DAC DC SPECIFICATIONS

Nominal supplies with DAC output full-scale current ( $I_{OUTFS}$ ) = 26 mA, unless otherwise noted. ADC setup in 4 GSPS, full BW mode (all digital downconverters bypassed). For the minimum and maximum values,  $T_J = -40^\circ\text{C}$  to  $+120^\circ\text{C}$ , and for the typical values,  $T_A = 25^\circ\text{C}$ , which corresponds to  $T_J = 80^\circ\text{C}$ , unless otherwise noted.

Table 3. DAC DC Specifications

Parameter	Test Conditions/Comments	Min	Typ	Max	Unit
DAC RESOLUTION		16			Bit
DAC ACCURACY					
Gain Error			1.5		%FSR
Gain Matching			0.7		%FSR
Integral Nonlinearity (INL)	Shuffling disabled		8.0		LSB
Differential Nonlinearity (DNL)	Shuffling disabled		3.5		LSB
DAC ANALOG OUTPUTS	DACxP and DACxN				
Full-Scale Output Current Range	AC coupling, setting resistance ( $R_{SET}$ ) = 5 k $\Omega$				
AC Coupling	Output common-mode voltage ( $V_{CM}$ ) = 0 V	6.43	26.5	37.75	mA
DC Coupling	50 $\Omega$ shunt to a negative supply, forcing $V_{CM} = 0$ V	6.43		37.75	mA
DC Coupling	50 $\Omega$ shunt to GND, forcing $V_{CM} = 0.3$ V	6.43		20 <sup>1</sup>	mA
Full-Scale Sinewave Output Power with AC Coupling <sup>2</sup>	Ideal 2:1 balun interface to 50 $\Omega$				
$I_{OUTFS} = 26$ mA			3.3		dBm
$I_{OUTFS} = 40$ mA			7		dBm
Common-Mode Output Voltage ( $V_{CMOUT}$ )			0		V
AC Coupling	Bias each output to GND across a shunt inductor		0		V
DC Coupling	Bias each output to a negative voltage rail across a 25 $\Omega$ to 200 $\Omega$ resistor, selected such that $V_{CMOUT} = 0$ V; $V_{CMOUT} = 0.3$ V is with a 25 $\Omega$ resistor to GND and $I_{FSC} = 20$ mA			0.3	V
Differential Resistance			100		$\Omega$

<sup>1</sup> For dc-coupled applications, the maximum full-scale output current is limited by the maximum  $V_{CMOUT}$  specification.

<sup>2</sup> The actual measured full-scale power is frequency dependent due to DAC sinc response, impedance mismatch loss, and balun insertion loss.

## SPECIFICATIONS

## ADC DC SPECIFICATIONS

Nominal supplies with DAC output full-scale current ( $I_{OUTFS}$ ) = 26 mA, unless otherwise noted. ADC setup in 4 GSPS, full BW mode (all digital downconverters bypassed). For the minimum and maximum values,  $T_J = -40^{\circ}\text{C}$  to  $+120^{\circ}\text{C}$ , and for the typical values,  $T_A = 25^{\circ}\text{C}$ , which corresponds to  $T_J = 80^{\circ}\text{C}$ , unless otherwise noted.

Table 4. ADC DC Specifications

Parameter	Test Conditions/Comments	Min	Typ	Max	Unit
ADC RESOLUTION		12			Bit
ADC ACCURACY					
No Missing Codes			Guaranteed		
Offset Error			-0.20		%FSR
Offset Matching			+0.05		%FSR
Gain Error			-0.71		%FSR
Gain Matching			+1.2		%FSR
DNL			$\pm 1.9$		LSB
INL			$\pm 0.5$		LSB
ADC ANALOG INPUTS	ADCxP and ADCxN				
Differential Input Voltage			1.4		V p-p
Full-Scale Sine Wave Input Power	Input power level resulting 0 dBFS tone level on fast Fourier transform (FFT)		3.9		dBm
Common-Mode Input Voltage ( $V_{CMIN}$ )	AC-coupled, equal to voltage at VCMx for ADCx input		1		V
Differential Input Impedance			100//0.4		$\Omega//\text{pF}$
Return Loss	<2.7 GHz		-4.3		dB
	2.7 GHz to 3.8 GHz		-3.6		dB
	3.8 GHz to 5.4 GHz		-2.9		dB

## SPECIFICATIONS

## CLOCK INPUTS AND OUTPUTS

For the minimum and maximum values,  $T_J = -40^{\circ}\text{C}$  to  $+120^{\circ}\text{C}$  and  $\pm 5\%$  of nominal supply, unless otherwise noted.

Table 5. Clock Input and Outputs

Parameter	Test Conditions/Comments	Min	Typ	Max	Unit
<b>CLOCK INPUTS</b>					
Differential Input Power	CLKINP and CLKINN Direct RF clock				
Minimum				0	dBm
Maximum				6	dBm
Common-Mode Voltage	AC-coupled			0.5	V
Differential Input Impedance				100//0.3	$\Omega$ //pF
<b>CLOCK OUTPUTS (ADC CLOCK DRIVER)</b>					
Differential Output Voltage Magnitude <sup>1</sup>	ADCDRVP and ADCDRVN				
	1.5 GHz			740	mV p-p
	2.0 GHz			690	mV p-p
	3.0 GHz			640	mV p-p
	6.0 GHz			490	mV p-p
Differential Output Resistance				100	$\Omega$
Common-Mode Voltage	AC-coupled			0.5	$\Omega$

<sup>1</sup> Measured with differential 100  $\Omega$  load and less than 2 mm of printed circuit board (PCB) trace from package ball.

## CLOCK INPUT AND PHASE-LOCKED LOOP (PLL) FREQUENCY SPECIFICATIONS

For the minimum and maximum values,  $T_J = -40^{\circ}\text{C}$  to  $+120^{\circ}\text{C}$  and  $\pm 5\%$  of nominal supply, unless otherwise noted.

Table 6.

Parameter	Test Conditions/Comments	Min	Typ	Max	Unit
CLOCK INPUTS (CLKINP, CLKINN) FREQUENCY RANGES		25		12000	MHz
PHASE FREQUENCY DETECTOR (PFD) INPUT FREQUENCY RANGES		25		750	MHz
<b>FREQUENCY RANGES ACCORDING TO CLOCK PATH CONFIGURATION</b>					
Direct Clock (PLL Off)		2900 <sup>1</sup>		12000	MHz
PLL Reference Clock (PLL On)	M divider set to divide by 1	25		750	MHz
	M divider set to divide by 2	50		1500	MHz
	M divider set to divide by 3	75		2250	MHz
	M divider set to divide by 4	100		3000	MHz
<b>PLL VOLTAGE CONTROLLED OSCILLATOR (VCO) FREQUENCY RANGES</b>					
VCO Output					
Divide by 1	D divider set to divide by 1	5.8		12	GHz
Divide by 2	D divider set to divide by 2	2.9		6	GHz
Divide by 3	D divider set to divide by 3	1.93333		4	GHz
Divide by 4	D divider set to divide by 4	1.45		3	GHz

<sup>1</sup> The minimum direct clock frequency is limited by the minimum DAC (core) sample rate, as specified in Table 7. The clock receiver can accommodate the full range between the minimum PLL reference clock frequency and the maximum direct clock frequency.

## DAC SAMPLE RATE SPECIFICATIONS

Nominal supplies. For the minimum and maximum values,  $T_J = -40^{\circ}\text{C}$  to  $+120^{\circ}\text{C}$  and  $\pm 5\%$  of nominal supply. For the typical values,  $T_A = 25^{\circ}\text{C}$ , which corresponds to  $T_J = 80^{\circ}\text{C}$ , unless otherwise noted.

**SPECIFICATIONS****Table 7. DAC Sample Rate Specifications**

Parameter	Min	Typ	Max	Unit
DAC SAMPLE RATE <sup>1</sup>				
Minimum			2.9	GSPS
Maximum	12			GSPS

<sup>1</sup> Pertains to the update rate of the DAC core, independent of datapath and JESD204 mode configuration.



## SPECIFICATIONS

## ADC SAMPLE RATE SPECIFICATIONS

Nominal supplies. For the minimum and maximum values,  $T_J = -40^{\circ}\text{C}$  to  $+120^{\circ}\text{C}$  and  $\pm 5\%$  of nominal supply. For the typical values,  $T_A = 25^{\circ}\text{C}$ , which corresponds to  $T_J = 80^{\circ}\text{C}$ , unless otherwise noted.

**Table 8. ADC Sample Rate Specifications**

Parameter	Min	Typ	Max	Unit
ADC SAMPLE RATE <sup>1</sup>				
Minimum			1.45	GSPS
Maximum	4			GSPS
Aperture Jitter <sup>2</sup>		65		fs rms

<sup>1</sup> Pertains to the update rate of the ADC core, independent of datapath and JESD204 mode configuration.

<sup>2</sup> Measured using a signal-to-noise ratio (SNR) degradation method with the DAC disabled, clock divider = 1, ADC frequency ( $f_{\text{ADC}}$ ) = 4 GSPS, and input frequency ( $f_{\text{IN}}$ ) = 5.55 GHz.

## SPECIFICATIONS

## INPUT DATA RATES SPECIFICATIONS

For the minimum and maximum values,  $T_J = -40^{\circ}\text{C}$  to  $+120^{\circ}\text{C}$  and  $\pm 5\%$  of nominal supply, unless otherwise noted.

Table 9.

Parameter <sup>1 2</sup>	Test Conditions/Comments	Min	Typ	Max	Unit
MAXIMUM DATA RATE PER NUMBER OF ACTIVE DAC OUTPUTS	Single DAC, FDUC bypassed, 1 CDUC enabled (not bypassable), 12-bit or 16-bit resolution; limited by the maximum DAC clock rate and the minimum total interpolation of 2× inside the CDUC block			6000	MSPS
	Quad DAC, FDUC bypassed, 4 CDUCs enabled (not bypassable), 12-bit resolution; limited by the maximum JESD204C link throughput (M = 8, L = 8) and the minimum total interpolation of 2× inside the CDUC block			2000	MSPS
MAXIMUM COMPLEX (I/Q) DATA RATE PER NUMBER OF ACTIVE INPUT DATA CHANNELS	1 channel: FDUC bypassed, 1 CDUC enabled, 12-bit or 16-bit resolution; limited by the maximum CDUC NCO clock rate			6000	MSPS
	2 channels: FDUC bypassed, 2 CDUCs enabled, 12-bit resolution; limited by the maximum JESD204C link throughput (M = 4, L = 8)			4000	MSPS
	4 channels: FDUC bypassed, 4 CDUCs enabled, 12-bit resolution; limited by the maximum JESD204C link throughput (M = 8, L = 8)			2000	MSPS
	8 channels: 8 FDUCs enabled, one or more CDUC enabled, 12-bit or 16-bit resolution; limited by the maximum FDUC NCO clock rate divided by the minimum 2x interpolation rate required to enable the FDUC			750	MSPS

<sup>1</sup> The values listed for these parameters are the maximum possible when considering all JESD204 modes of operation. Some modes are more limiting, based on other parameters.

<sup>2</sup> The interpolation filters in the Tx datapath have a total complex filter bandwidth of 80% of the data rate, combining the 40% bandwidth in the I path and 40% bandwidth in the Q path. Similarly, the decimation stages inside the Rx datapath use filters with a total complex filter bandwidth of 81.4%. Therefore, the maximum allowed instantaneous complex signal bandwidth (iBW) per channel is calculated as  $iBW = [\text{Complex I/Q Data Rate per Channel}] \times [\text{Total Complex Filter Bandwidth}]$ .

## SPECIFICATIONS

## NCO FREQUENCY SPECIFICATIONS

For the minimum and maximum values,  $T_J = -40^\circ\text{C}$  to  $+120^\circ\text{C}$  and  $\pm 5\%$  of nominal supply, unless otherwise noted.

Table 10.

Parameter	Test Conditions/Comments	Min	Typ	Max	Unit
MAXIMUM NUMERICALLY CONTROLLED OSCILLATOR (NCO) CLOCK RATE					
FDUC NCO				1.5	GHz
CDUC NCO				12	GHz
FDDC NCO				1.5	GHz
CDDC NCO				4	GHz
MAXIMUM NCO SHIFT FREQUENCY RANGE					
FDUC NCO	channel interpolation rate must be $> 1\times$	-750		+750	MHz
CDUC NCO	$f_{\text{DAC}} = 12$ GHz, main interpolation rate must be $> 1\times$	-6		+6	GHz
FDDC NCO	channel decimation rate must be $> 1\times$	-750		+750	MHz
CDDC NCO	$f_{\text{ADC}} = 4$ GHz, main decimation rate must be $> 1\times$	-2		+2	GHz
MAXIMUM FREQUENCY SPACING BETWEEN CHANNELIZER CHANNELS					
Tx FDUC Channels	Maximum FDUC NCO clock rate $\times 0.8^1$			1200	MHz
Rx FDDC Channels	Maximum FDDC NCO clock rate $\times 0.814^2$			1221	MHz

<sup>1</sup> The 0.8 factor is because the total complex pass-band of the first interpolation filter is 80% of the filter input data rate.

<sup>2</sup> The 0.814 factor is because the total complex pass-band of the decimation filter is 81.4% of the filter output data rate.

## JESD204B AND JESD204C INTERFACE ELECTRICAL AND SPEED SPECIFICATIONS

Nominal supplies. For the minimum and maximum values,  $T_J = -40^\circ\text{C}$  to  $+120^\circ\text{C}$  and  $\pm 5\%$  of nominal supply, and for the typical values,  $T_A = 25^\circ\text{C}$ , which corresponds to  $T_J = 80^\circ\text{C}$ , unless otherwise noted.

Table 11. Serial Interface Rate Specifications

Parameter	Test Conditions/Comments	Min	Typ	Max	Unit
JESD204B SERIAL INTERFACE RATE	Serial lane rate (bit repeat option disabled)	1.0		15.5	Gbps
Unit Interval		64.5		1000.0	ps
JESD204C SERIAL INTERFACE RATE	Serial lane rate (bit repeat option disabled)	6.0		24.75	Gbps
Unit Interval		40.4		166.67	ps

Table 12. JESD204 Receiver (JR<sub>x</sub>) Electrical Specifications

Parameter	Test Conditions/Comments	Min	Typ	Max	Unit
JESD204x DATA INPUTS	SERDIN <sub>x</sub> ±, where x = 0 to 7				
Standards Compliance			JESD204B and JESD204C		
Differential Voltage, $R_{\text{VDIFF}}$			800		mV p-p
Differential Impedance, $Z_{\text{RDIFF}}$	At dc		98		$\Omega$
Termination Voltage, $V_{\text{TT}}$	AC-coupled		0.97		V
SYNC <sub>x</sub> OUTB± OUTPUTS <sup>1</sup>	Where x = 0 or 1				
Output Differential Voltage, $V_{\text{OD}}$	Driving 100 $\Omega$ differential load		400		mV
Output Offset Voltage, $V_{\text{OS}}$			DVDD1P8/2 + 0.2		V
SYNC <sub>x</sub> OUTB+ OUTPUT	CMOS output option		Refer to <a href="#">CMOS Pin Specifications</a>		

<sup>1</sup> IEEE 1596.3 standard LVDS compatible.

Table 13. JESD204 Transmitter (JT<sub>x</sub>) Electrical Specifications

Parameter	Test Conditions/Comments	Min	Typ	Max	Unit
JESD204x DATA OUTPUTS	SERDOUT <sub>x</sub> ±, where x = 0 to 7				

## SPECIFICATIONS

Table 13. JESD204 Transmitter (JT<sub>x</sub>) Electrical Specifications

Parameter	Test Conditions/Comments	Min	Typ	Max	Unit
Standards Compliance			JESD204B and JESD204C		
Differential Output Voltage	Maximum strength		675		mV p-p
Differential Termination Impedance		80	108	120	Ω
Rise Time, t <sub>R</sub>	20% to 80% into 100 Ω load		18		ps
Fall Time, t <sub>F</sub>	20% to 80% into 100 Ω load		18		ps
SYNCxINB± INPUT <sup>1</sup>	Where x = 0 or 1				
Logic Compliance			LVDS		
Differential Input Voltage		240	0.7	1900	mV p-p
Input Common-Mode Voltage	DC-coupled		0.675	2	V
R <sub>IN</sub> (Differential)			18		kΩ
Input Capacitance (Differential)			1		pF
SYNCxINB+ INPUT	CMOS input option		Refer to <a href="#">CMOS Pin Specifications</a>		

<sup>1</sup> IEEE 1596.3 standard LVDS compatible.

## SPECIFICATIONS

Table 14. SYSREF Electrical Specifications

Parameter	Test Conditions/Comments	Min	Typ	Max	Unit
SYSREF+ AND SYSREF- INPUTS					
Logic Compliance			LVDS/LVPECL <sup>1</sup>		
Differential Input Voltage			0.7	1.9	V p-p
Input Common-Mode Voltage Range	DC-coupled		0.675	2	V
Input Reference, R <sub>IN</sub> (Differential)			100		Ω
Input Capacitance (Differential)			1		pF

<sup>1</sup> LVDS means low voltage differential signaling and LVPECL means low voltage positive/pseudo emitter-coupled logic.

## SPECIFICATIONS

## CMOS PIN SPECIFICATIONS

For the minimum and maximum values,  $T_J = -40^{\circ}\text{C}$  to  $+120^{\circ}\text{C}$ ,  $1.7\text{ V} \leq \text{DVDD1P8} \leq 2.1\text{ V}$ , other supplies nominal, unless otherwise noted.

Table 15.

Parameter	Symbol	Test Conditions/Comments	Min	Typ	Max	Unit	
<b>INPUTS</b>							
Logic 1 Voltage	$V_{IH}$	SDIO, SCLK, CSB, RESETB, RXEN0, RXEN1, TXEN0, TXEN1, SYNC0INB $\pm$ , SYNC1INB $\pm$ , and GPIOx	$0.70 \times \text{DVDD1P8}$			V	
Logic 0 Voltage	$V_{IL}$					$0.3 \times \text{DVDD1P8}$	V
Input Resistance				40			k $\Omega$
<b>OUTPUTS</b>							
Logic 1 Voltage	$V_{OH}$	SDIO, SDO, GPIOx, ADCx_FDX, ADCx_SMONx, SYNC0OUTB $\pm$ , and SYNC1OUTB $\pm$ , 4 mA load	$\text{DVDD1P8} - 0.45$			V	
Logic 0 Voltage	$V_{OL}$					0.45	V
<b>INTERRUPT OUTPUTS</b>							
Logic 1 Voltage	$V_{OH}$	IRQB_0 and IRQB_1, pull-up resistor of 5 k $\Omega$ to DVDD1P8	1.35			V	
Logic 0 Voltage	$V_{OL}$					0.48	V

## DAC AC SPECIFICATIONS

Nominal supplies with  $T_A = 25^{\circ}\text{C}$ . Specifications represent the average of all four DAC channels with the DAC  $I_{OUTFS} = 26\text{ mA}$ , unless otherwise noted.

Table 16.

Parameter	Test Conditions/Comments	Min	Typ	Max	Unit	
<b>SPURIOUS-FREE DYNAMIC RANGE (SFDR)</b>						
Single-Tone, $f_{DAC} = 12\text{ GSPS}$	-7 dBFS digital back off, shuffle enabled, 15C mode					
Output Frequency ( $f_{OUT}$ ) = 70 MHz		63	80		dBc	
$f_{OUT} = 100\text{ MHz}$			77		dBc	
$f_{OUT} = 500\text{ MHz}$			76		dBc	
$f_{OUT} = 900\text{ MHz}$			77		dBc	
$f_{OUT} = 1900\text{ MHz}$		61	79		dBc	
$f_{OUT} = 2600\text{ MHz}$			75		dBc	
$f_{OUT} = 3700\text{ MHz}$			69		dBc	
$f_{OUT} = 4500\text{ MHz}$			68		dBc	
Single-Tone, $f_{DAC} = 9\text{ GSPS}$		-7 dBFS digital back off, shuffle enabled, 15C mode				
$f_{OUT} = 100\text{ MHz}$				78		dBc
$f_{OUT} = 500\text{ MHz}$				78		dBc
$f_{OUT} = 900\text{ MHz}$				77		dBc
$f_{OUT} = 1900\text{ MHz}$				80		dBc
$f_{OUT} = 2600\text{ MHz}$			80		dBc	
$f_{OUT} = 3700\text{ MHz}$		72		dBc		
Single-Tone, $f_{DAC} = 6\text{ GSPS}$	-7 dBFS digital back off, shuffle enabled, 15C mode					
$f_{OUT} = 100\text{ MHz}$			84		dBc	
$f_{OUT} = 500\text{ MHz}$			81		dBc	
$f_{OUT} = 900\text{ MHz}$			82		dBc	
$f_{OUT} = 1900\text{ MHz}$		81		dBc		
<b>ADJACENT CHANNEL LEAKAGE RATIO</b>						
Single Carrier 20 MHz LTE Downlink Test Vector	-1 dBFS digital back off, 256 QAM					
$f_{DAC} = 12\text{ GSPS}$						
		$f_{OUT} = 1840\text{ MHz}$	77		dBc	
	$f_{OUT} = 2650\text{ MHz}$	76		dBc		

## SPECIFICATIONS

Table 16.

Parameter	Test Conditions/Comments	Min	Typ	Max	Unit
$f_{DAC} = 9$ GSPS	$f_{OUT} = 3500$ MHz		73		dBc
	$f_{OUT} = 1900$ MHz		77		dBc
	$f_{OUT} = 2650$ MHz		77		dBc
$f_{DAC} = 6$ GSPS	$f_{OUT} = 750$ MHz		79		dBc
	$f_{OUT} = 1840$ MHz		77		dBc
THIRD-ORDER INTERMODULATION DISTORTION (IMD3)	Two tone test, 1 MHz spacing, 0 dBFS digital back off, -6 dBFS per tone				
$f_{DAC} = 12$ GSPS	$f_{OUT} = 1900$ MHz		-69	-62	dBc
	$f_{OUT} = 2600$ MHz		-72		dBc
	$f_{OUT} = 3700$ MHz		-72		dBc
$f_{DAC} = 9$ GSPS	$f_{OUT} = 1900$ MHz		-79		dBc
	$f_{OUT} = 2600$ MHz		-76		dBc
$f_{DAC} = 6$ GSPS	$f_{OUT} = 900$ MHz		-79		dBc
	$f_{OUT} = 1900$ MHz		-90		dBc
NOISE SPECTRAL DENSITY (NSD)	0 dBFS, NSD measurement taken at 10% away from $f_{OUT}$ , shuffle off				
Single-Tone, $f_{DAC} = 12$ GSPS					
$f_{OUT} = 150$ MHz			-168		dBc/Hz
$f_{OUT} = 500$ MHz			-167		dBc/Hz
$f_{OUT} = 950$ MHz			-165		dBc/Hz
$f_{OUT} = 1840$ MHz			-162		dBc/Hz
$f_{OUT} = 2650$ MHz			-160		dBc/Hz
$f_{OUT} = 3700$ MHz			-155		dBc/Hz
$f_{OUT} = 4500$ MHz			-154		dBc/Hz
Single-Tone, $f_{DAC} = 9$ GSPS					
$f_{OUT} = 150$ MHz			-168		dBc/Hz
$f_{OUT} = 500$ MHz			-166		dBc/Hz
$f_{OUT} = 950$ MHz			-164		dBc/Hz
$f_{OUT} = 1840$ MHz			-160		dBc/Hz
$f_{OUT} = 2650$ MHz			-158		dBc/Hz
$f_{OUT} = 3700$ MHz			-154		dBc/Hz
Single-Tone, $f_{DAC} = 6$ GSPS					
$f_{OUT} = 150$ MHz			-168		dBc/Hz
$f_{OUT} = 500$ MHz			-165		dBc/Hz
$f_{OUT} = 950$ MHz			-163		dBc/Hz
$f_{OUT} = 1840$ MHz			-159		dBc/Hz
$f_{OUT} = 2650$ MHz			-157		dBc/Hz
SINGLE SIDEBAND PHASE NOISE OFFSET (PLL DISABLED)	Direct device clock input at 6 dBm				
$f_{OUT} = 3.6$ GHz, $f_{DAC} = 12$ GSPS, CLKINx Frequency ( $f_{CLKIN}$ ) = 12 GHz	Rohde & Schwarz SMA100B B711 option				
1 kHz			-118		dBc/Hz
10 kHz			-129		dBc/Hz
100 kHz			-137		dBc/Hz
600 kHz			-144		dBc/Hz
1.2 MHz			-148		dBc/Hz
1.8 MHz			-149		dBc/Hz
6 MHz			-153		dBc/Hz
SINGLE SIDEBAND PHASE NOISE OFFSET (PLL ENABLED)	Loop filter component values include $C1 = 22$ nF, $R1 = 226$ $\Omega$ , $C2 = 2.2$ nF,				

## SPECIFICATIONS

Table 16.

Parameter	Test Conditions/Comments	Min	Typ	Max	Unit
$f_{OUT} = 1.8 \text{ GHz}$ , $f_{DAC} = 12 \text{ GSPS}$ , $f_{CLKIN} = 0.5 \text{ GHz}$	C3 = 33 nF, and phase detector frequency (PFD) = 500 MHz				
1 kHz			-106		dBc/Hz
10 kHz			-113		dBc/Hz
100 kHz			-120		dBc/Hz
600 kHz			-127		dBc/Hz
1.2 MHz			-134		dBc/Hz
1.8 MHz			-138		dBc/Hz
6 MHz			-150		dBc/Hz

## ADC AC SPECIFICATIONS

Nominal supplies with  $T_A = 25^\circ\text{C}$ . Input amplitude ( $A_{IN}$ ) = -1 dBFS, full bandwidth (no decimation) mode. For the minimum and maximum values,  $T_J = -40^\circ\text{C}$  to  $+120^\circ\text{C}$ . Specifications represent average of four ADC channels with DACs powered on. See the [AN-835 Application Note, Understanding High Speed ADC Testing and Evaluation](#), for definitions and for details on how these tests were completed.

Table 17.

Parameter	3 GSPS			4 GSPS			Unit
	Min	Typ	Max	Min	Typ	Max	
NOISE DENSITY <sup>1</sup>		-150.3			-151.5		dBFS/Hz
NOISE FIGURE <sup>2</sup>		28			26.8		dB
CODE ERROR RATE (CER)		$<1 \times 10^{-30}$			$1 \times 10^{-20}$		Errors
SIGNAL-TO-NOISE RATIO (SNR)							
$f_{IN} = 450 \text{ MHz}$		57.8			57.9		dBFS
$f_{IN} = 900 \text{ MHz}$		57.7			57.5		dBFS
$f_{IN} = 1800 \text{ MHz}$		56.9			56.0		dBFS
$f_{IN} = 2700 \text{ MHz}$		55.9		52.4	54.5		dBFS
$f_{IN} = 3600 \text{ MHz}$		55.1			52.9		dBFS
$f_{IN} = 4500 \text{ MHz}$		53.9			51.4		dBFS
$f_{IN} = 5400 \text{ MHz}$		53.2			50.5		dBFS
$f_{IN} = 6300 \text{ MHz}$		52.3			49.3		dBFS
$f_{IN} = 7200 \text{ MHz}$		51.3			48.5		dBFS
SIGNAL-TO-NOISE-AND-DISTORTION (SINAD)							
$f_{IN} = 450 \text{ MHz}$		57.5			57.7		dBFS
$f_{IN} = 900 \text{ MHz}$		57.2			57.3		dBFS
$f_{IN} = 1800 \text{ MHz}$		56.1			55.8		dBFS
$f_{IN} = 2700 \text{ MHz}$		54.5		51.0	54.2		dBFS
$f_{IN} = 3600 \text{ MHz}$		53.2			52.3		dBFS
$f_{IN} = 4500 \text{ MHz}$		48.4			50.1		dBFS
$f_{IN} = 5400 \text{ MHz}$		47.8			48.6		dBFS
$f_{IN} = 6300 \text{ MHz}$		46.1			45.5		dBFS
$f_{IN} = 7200 \text{ MHz}$		44.8			44.3		dBFS
SECOND-ORDER HARMONIC DISTORTION (HD2)							
$f_{IN} = 450 \text{ MHz}$		-73			-86		dBFS
$f_{IN} = 900 \text{ MHz}$		-76			-78		dBFS
$f_{IN} = 1800 \text{ MHz}$		-71			-78		dBFS
$f_{IN} = 2700 \text{ MHz}$		-65			-67	-53	dBFS
$f_{IN} = 3600 \text{ MHz}$		-61			-61		dBFS
$f_{IN} = 4500 \text{ MHz}$		-55			-56		dBFS



## SPECIFICATIONS

Table 17.

Parameter	3 GSPS			4 GSPS			Unit
	Min	Typ	Max	Min	Typ	Max	
$f_{IN} = 5400$ MHz		-50			-53		dBFS
$f_{IN} = 6300$ MHz		-48			-48		dBFS
$f_{IN} = 7200$ MHz		-46			-46		dBFS
THIRD-ORDER HARMONIC DISTORTION (HD3)							
$f_{IN} = 450$ MHz		-78			-76		dBFS
$f_{IN} = 900$ MHz		-79			-76		dBFS
$f_{IN} = 1800$ MHz		-78			-75		dBFS
$f_{IN} = 2700$ MHz		-76			-73	-66	dBFS
$f_{IN} = 3600$ MHz		-71			-76		dBFS
$f_{IN} = 4500$ MHz		-62			-64		dBFS
$f_{IN} = 5400$ MHz		-60			-60		dBFS
$f_{IN} = 6300$ MHz		-59			-57		dBFS
$f_{IN} = 7200$ MHz		-58			-54		dBFS
WORST OTHER, EXCLUDING HD2, HD3, AND INTERLEAVING SPURS							
$f_{IN} = 450$ MHz		-78			-88		dBFS
$f_{IN} = 900$ MHz		-78			-87		dBFS
$f_{IN} = 1800$ MHz		-78			-81		dBFS
$f_{IN} = 2700$ MHz		-78			-79	-64	dBFS
$f_{IN} = 3600$ MHz		-78			-77		dBFS
$f_{IN} = 4500$ MHz		-77			-75		dBFS
$f_{IN} = 5400$ MHz		-78			-74		dBFS
$f_{IN} = 6300$ MHz		-74			-72		dBFS
$f_{IN} = 7200$ MHz		-73			-72		dBFS
INTERLEAVING SPUR ( $f_{IN} \pm f_S/2$ ) <sup>3</sup>							
$f_{IN} = 450$ MHz		-97			-93		dBFS
$f_{IN} = 900$ MHz		-94			-93		dBFS
$f_{IN} = 1800$ MHz		-96			-90		dBFS
$f_{IN} = 2700$ MHz		-86			-86		dBFS
$f_{IN} = 3600$ MHz		-84			-81		dBFS
$f_{IN} = 4500$ MHz		-53			-85		dBFS
$f_{IN} = 5400$ MHz		-78			-86		dBFS
$f_{IN} = 6300$ MHz		-77			-79		dBFS
$f_{IN} = 7200$ MHz		-78			-74		dBFS
DIGITAL COUPLING SPUR ( $f_{IN} \pm f_S/4$ )							
$f_{IN} = 450$ MHz		-83			-94		dBFS
$f_{IN} = 900$ MHz		-79			-91		dBFS
$f_{IN} = 1800$ MHz		-73			-89		dBFS
$f_{IN} = 2700$ MHz		-70			-86	-67	dBFS
$f_{IN} = 3600$ MHz		-68			-87		dBFS
$f_{IN} = 4500$ MHz		-66			-83		dBFS
$f_{IN} = 5400$ MHz		-65			-82		dBFS
$f_{IN} = 6300$ MHz		-64			-80		dBFS
$f_{IN} = 7200$ MHz		-63			-79		dBFS
TWO-TONE INTERMODULATION DISTORTION (IMD3, $2f_{IN1} - f_{IN2}$ OR $2f_{IN2} - f_{IN1}$ ) $A_{IN1}$ AND $A_{IN2} = -7$ dBFS							
$f_{IN1} = 1775$ MHz, $f_{IN2} = 1825$ MHz		-81			-84		dBFS
$f_{IN1} = 2675$ MHz, $f_{IN2} = 2725$ MHz		-77			-78		dBFS

## SPECIFICATIONS

Table 17.

Parameter	3 GSPS			4 GSPS			Unit
	Min	Typ	Max	Min	Typ	Max	
$f_{IN1} = 3575 \text{ MHz}$ , $f_{IN2} = 3625 \text{ MHz}$		-73			-74		dBFS
$f_{IN1} = 5375 \text{ MHz}$ , $f_{IN2} = 5425 \text{ MHz}$		-66			-66		dBFS
ANALOG BANDWIDTH <sup>4</sup>		7.5			7.5		GHz

<sup>1</sup> Noise density is measured at 250 MHz input frequency at -30 dBFS, where timing jitter does not degrade noise floor.

<sup>2</sup> Noise figure is based on a nominal full-scale input power of 4.5 dBm with an input span of 1.4 V p-p and  $R_{IN} = 100 \Omega$ .

<sup>3</sup> With background interleaving calibration converged.

<sup>4</sup> Analog input bandwidth is the bandwidth of operation in which the full-scale input frequency response rolls off by -3 dB based on a de-embedded model of the ADC extracted from the measured frequency response on evaluation board. This bandwidth requires optimized matching network to achieve this upper bandwidth.

## TIMING SPECIFICATIONS

For the minimum and maximum values,  $T_J = -40^\circ\text{C}$  to  $+120^\circ\text{C}$  and  $\pm 5\%$  of nominal supply, unless otherwise noted.

Table 18.

Parameter	Symbol	Test Conditions/Comments	Min	Typ	Max	Unit
SERIAL PORT INTERFACE (SPI) WRITE OPERATION						
Maximum SCLK Clock Rate	$f_{SCLK}$ , $1/t_{SCLK}$		33			MHz
SCLK Clock High	$t_{PWH}$	SCLK = 33 MHz	8			ns
SCLK Clock Low	$t_{PWL}$	SCLK = 33 MHz	8			ns
SDIO to SCLK Setup Time	$t_{DS}$		4			ns
SCLK to SDIO Hold Time	$t_{DH}$		4			ns
CSB to SCLK Setup Time	$t_S$		4			ns
CLK to CSB Hold Time	$t_H$		4			ns
SPI READ OPERATION						
LSB First Data Format						
Maximum SCLK Clock Rate	$f_{SCLK}$ , $1/t_{SCLK}$		33			MHz
SCLK Clock High	$t_{PWH}$		8			ns
SCLK Clock Low	$t_{PWL}$		8			ns
MSB First Data Format						
Maximum SCLK Clock Rate	$f_{SCLK}$ , $1/t_{SCLK}$		15			MHz
SCLK Clock High	$t_{PWH}$		30			ns
SCLK Clock Low	$t_{PWL}$		30			ns
SDIO to SCLK Setup Time	$t_{DS}$		4			ns
SCLK to SDIO Hold Time	$t_{DH}$		4			ns
CSB to SCLK Setup Time	$t_S$		4			ns
SCLK to SDIO Data Valid Time	$t_{DV}$		20			ns
SCLK to SDO Data Valid Time	$t_{DV\_SDO}$		20			ns
CSB to SDIO Output Valid to High-Z	$t_Z$		20			ns
CSB to SDO Output Valid to High-Z	$t_{Z\_SDO}$		20			ns
RESETB		Minimum hold time to trigger a device reset	40			ns

SPECIFICATIONS

Timing Diagrams

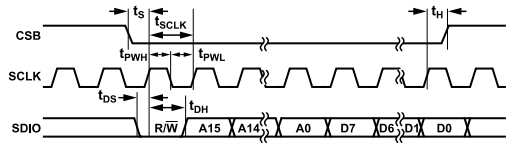

Figure 2. Timing Diagram for 3-Wire Write Operation

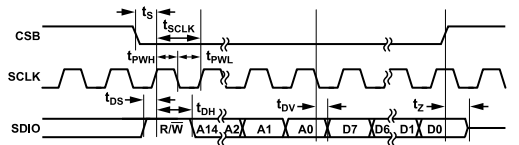

Figure 3. Timing Diagram for 3-Wire Read Operation

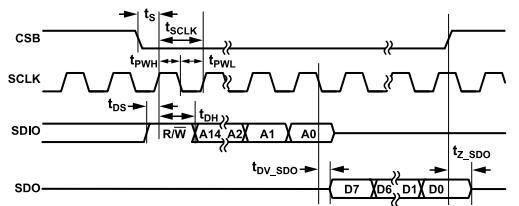

Figure 4. Timing Diagram for 4-Wire Read Operation

## ABSOLUTE MAXIMUM RATINGS

Table 19.

Parameter	Rating
ISSET, DACxP, DACxN, TDP, TDN	-0.3 V to AVDD2 + 0.3 V
VCO_COARSE, VCO_FINE, VCO_VCM, VCO_VREG	-0.3 V to AVDD2_PLL + 0.3 V
Rx Input Power (ADC0P/N, ADC1P/N, ADC2P/N, ADC3P/N) <sup>1</sup>	22 dBm
VCM0, VCM1	-0.3 V to RVDD2 + 0.3 V
CLKINP, CLKINN	-0.2 V to PLLCLKVDD1 + 0.2 V
ADCDRVN, ADCDRVP	-0.2 V to CLKVDD1 + 0.2 V
SERDINx±, SERDOUTx±	-0.2 V to SVDD1 + 0.2 V
SYSREFP, SYSREFN, and SYNCxINB±	-0.2 V to +2.5 V
SYNCxOUTB±, SYNCxINB±, RESETB, TXENx, RXENx, IRQB_x, CSB, SCLK, SDIO, SDO, TMU_REFN, TMU_REFP, ADCx_SMON0, ADCx_SMON1, ADCx_FD0, ADCx_FD1, GPIOx	-0.3 V to DVDD1P8 + 0.3 V
AVDD2, AVDD2_PLL, BVDD2, RVDD2, SVDD2_PLL, DVDD1P8	-0.3 V to +2.2 V
PLLCLKVDD1, AVDD1, AVDD1_ADC, CLKVDD1, FVDD1, DAVDD1, DVDD1_RT, DCLKVDD1, SVDD1, SVDD1_PLL	-0.2 V to +1.2 V
VNN1	-1.1 V to +0.2 V
Temperature Ranges	
Maximum Junction (T <sub>J</sub> ) <sup>2</sup>	120°C
Storage	-65°C to +150°C

<sup>1</sup> Tested continuously for 1000 hours with  $f_{IN} = 4.7$  GHz pulsed and continuous tone at maximum allowed junction temperature (T<sub>J</sub>). Refer to [UG-1578](#), the device user guide, for more information.

<sup>2</sup> Do not exceed this temperature for any duration of time when the device is powered.

Stresses at or above those listed under Absolute Maximum Ratings may cause permanent damage to the product. This is a stress rating only; functional operation of the product at these or any other conditions above those indicated in the operational section of this specification is not implied. Operation beyond the maximum operating conditions for extended periods may affect product reliability.

## THERMAL RESISTANCE

Thermal performance is directly linked to PCB design and operating environment. The use of appropriate thermal management techniques is recommended to ensure that the maximum T<sub>J</sub> does not exceed the limits shown in [Table 19](#).

θ<sub>JA</sub> is the natural convection, junction to ambient thermal resistance measured in a one cubic foot sealed enclosure.

θ<sub>JC\_TOP</sub> is the junction to case, thermal resistance.

θ<sub>JB</sub> is the junction to board, thermal resistance.

Table 20. Simulated Thermal Resistance<sup>1</sup>

PCB Type	Airflow Velocity (m/sec)	θ <sub>JA</sub>	θ <sub>JC_TOP</sub>	θ <sub>JB</sub>	Unit
JEDEC 2s2p Board	0.0	14.9	0.70	1.8	°C/W

<sup>1</sup> Thermal resistance values specified are simulated based on JEDEC specifications in compliance with JESD51-12 with the device power equal to 9 W.

## ESD CAUTION



**ESD (electrostatic discharge) sensitive device.** Charged devices and circuit boards can discharge without detection. Although this product features patented or proprietary protection circuitry, damage may occur on devices subjected to high energy ESD. Therefore, proper ESD precautions should be taken to avoid performance degradation or loss of functionality.

PIN CONFIGURATION AND FUNCTION DESCRIPTIONS

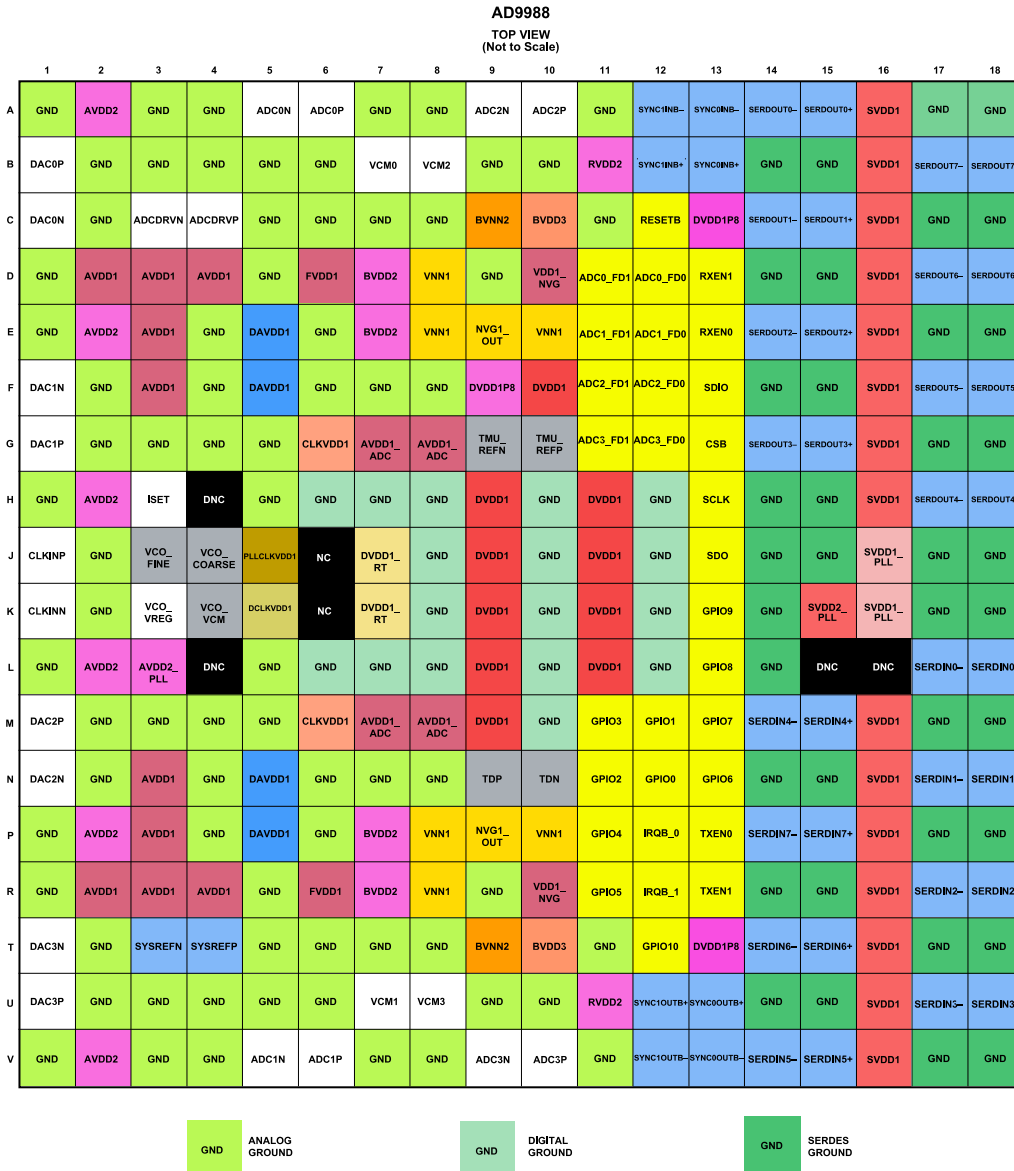

Figure 5. Pin Configuration

Table 21. Pin Function Descriptions

Pin No.	Mnemonic	Type	Description
<b>Power Supplies</b>			
A2, E2, H2, L2, P2, V2	AVDD2	Input	Analog 2.0 V Supply Inputs for DAC.
L3	AVDD2_PLL	Input	Analog 2.0 V Supply Input for Clock PLL Low Dropout (LDO) Regulator.
D7, E7, P7, R7	BVDD2	Input	Analog 2.0 V Supply Inputs for ADC Buffer.
B11, U11	RVDD2	Input	Analog 2.0 V Supply Inputs for ADC Reference.
J5	PLLCLKVDD1	Input	Analog 1.0 V Supply Input for Clock PLL.
D2, D3, D4, E3, F3, N3, P3, R2, R3, R4	AVDD1	Input	Analog 1.0 V Supply Inputs for DAC Clock.
G7, G8, M7, M8	AVDD1_ADC	Input	Analog 1.0 V Supply Inputs for ADC.
G6, M6	CLKVDD1	Input	Analog 1.0 V Supply Inputs for ADC Clock.
D6, R6	FVDD1	Input	Analog 1.0 V Supply Inputs for ADC Reference.

## PIN CONFIGURATION AND FUNCTION DESCRIPTIONS

Table 21. Pin Function Descriptions

Pin No.	Mnemonic	Type	Description
D10, R10	VDD1_NVG	Input	Analog 1.0 V Supply Inputs for Negative Voltage Generator (NVG) Used to Generate -1 V Output.
E9, P9	NVG1_OUT	Output	Analog -1 V Supply Outputs from NVG. Decouple NVG1_OUT to GND with a 0.1 $\mu$ F capacitor.
D8, E8, E10, P8, R8, P10	VNN1	Input	Analog -1 V Supply Inputs for ADC Buffer and Reference. Connect these pins to the adjacent NVG1_OUT pins.
C9, T9	BVNN2	Output	Decoupling Pin for the Internally Generated Analog -2 V ADC Buffer Supply. Decouple each BVNN2 pin to GND with a 0.1 $\mu$ F capacitor.
C10, T10	BVDD3	Output	Decoupling Pin for the Internally Generated Analog 3 V ADC Buffer Supply. Decouple BVDD3 to GND with a 0.1 $\mu$ F capacitor.
E5, F5, N5, P5	DAVDD1	Input	Digital Analog 1.0 V Supply Inputs.
F10, H9, H11, J9, J11, K9, K11, L9, L11, M9	DVDD1	Input	Digital 1.0 V Supply Inputs.
J7, K7	DVDD1_RT	Input	Digital 1.0 V Supply Inputs for Retimer Block.
K5	DCLKVDD1	Input	Digital 1.0 V Clock Generation Supply.
A16, B16, C16, D16, E16, F16, G16, H16, M16, N16, P16, R16, T16, U16, V16	SVDD1	Input	Digital 1.0 V Supply Inputs for SERDES Deserializer and Serializer.
K15	SVDD2_PLL	Input	Digital 2.0 V Supply Input for SERDES LDO Regulator.
J16, K16	SVDD1_PLL	Input	Digital 1.0 V Supply Inputs for SERDES Clock Generation and PLL.
C13, F9, T13	DVDD1P8	Input	Digital Interface and Temperature Monitoring Unit (TMU) Supply Inputs (Nominal 1.8 V).
A1, A3, A4, A7, A8, A11, A17, A18, B2 to B6, B9, B10, B14, B15, C2, C5 to C8, C11, C17, C18, D1, D5, D9, D14, D15, E1, E4, E6, E17, E18, F2, F4, F6 to F8, F14, F15, G2 to G5, G17, G18, H1, H5 to H8, H10, H12, H14, H15, J2, J8, J10, J12, J14, J15, J17, J18, K2, K8, K10, K12, K14, K17, K18, L1, L5 to L8, L10, L12, L14, M2 to M5, M10, M17, M18, N2, N4, N6 to N8, N14, N15, P1, P4, P6, P17, P18, R1, R5, R9, R14, R15, T2, T5 to T8, T11, T17, T18, U2 to U6, U9, U10, U14, U15, V1, V3, V4, V7, V8, V11, V17, V18	GND	Input/output	Ground References.
<b>Analog Outputs</b>			
B1, C1	DAC0P, DAC0N	Output	DAC0 Output Currents, Ground Referenced. Tie these pins to GND if unused.
G1, F1	DAC1P, DAC1N	Output	DAC1 Output Currents, Ground Referenced. Tie these pins to GND if unused.
M1, N1	DAC2P, DAC2N	Output	DAC2 Output Currents, Ground Referenced. Tie these pins to GND if unused.
U1, T1	DAC3P, DAC3N	Output	DAC3 Output Currents, Ground Referenced. Tie these pins to GND if unused.
H3	ISET	Output	DAC Bias Current Setting Pin. Connect this pin with a 5 k $\Omega$ resistor to GND.
C4, C3	ADCDRVP, ADCDRVN	Output	Optional Clock Output. These pins are disabled by default but can be used as a clock source for an external ADC or another device that requires a reference clock. Leave the pins floating if unused.
B7, U7, B8, U8	VCM0, VCM1, VCM2, VCM3	Output	ADC Buffer Common-Mode Output Voltage. Decouple these pins to GND with a 0.1 $\mu$ F capacitor.
K3	VCO_VREG	Output	PLL LDO Regulator Output. Decouple this pin to GND with a 2.2 $\mu$ F capacitor.
G9	TMU_REFN	Output	TMU ADC Negative Reference. Connect this pin to GND.

## PIN CONFIGURATION AND FUNCTION DESCRIPTIONS

Table 21. Pin Function Descriptions

Pin No.	Mnemonic	Type	Description
G10	TMU_REFP	Output	TMU ADC Positive Reference. Connect this pin to DVDD1P8.
<b>Analog Inputs</b>			
A6, A5	ADC0P, ADC0N	Input	ADC0 Differential Inputs with Internal 100 $\Omega$ Differential Resistor. Leave these pins floating if unused.
V6, V5	ADC1P, ADC1N	Input	ADC1 Differential Inputs with Internal 100 $\Omega$ Differential Resistor. Leave these pins floating if unused.
A10, A9	ADC2P, ADC2N	Input	ADC2 Differential Inputs with Internal 100 $\Omega$ Differential Resistor. Leave these pins floating if unused.
V10, V9	ADC3P, ADC3N	Input	ADC3 Differential Inputs with Internal 100 $\Omega$ Differential Resistor. Leave these pins floating if unused.
J3	VCO_FINE	Input	On-Chip Device Clock Multiplier and PLL Fine Loop Filter Input. If the PLL is not in use, leave this pin floating and disable the PLL via the control registers.
J4	VCO_COARSE	Input	On-Chip Device Clock Multiplier and PLL Coarse Loop Filter Input. If the PLL is not in use, leave this pin floating and disable the PLL via the control registers.
K4	VCO_VCM	Input	On-Chip Device Clock Multiplier and VCO Common-Mode Input. If the PLL is not in use, leave this pin floating and disable the PLL via the control registers.
N9, N10	TDP, TDN	Input	Anode and Cathode of Temperature Diodes. This feature is not supported. Tie TDP and TDN to GND.
J1, K1	CLKINP, CLKINN	Input	Differential Clock Inputs with Nominal 100 $\Omega$ Termination. These self biased inputs require ac coupling. When the on-chip clock multiplier PLL is enabled, this input is the reference clock input. If the PLL is disabled, an RF clock equal to the DAC output sample rate is required.
<b>CMOS Inputs and Outputs<sup>1</sup></b>			
G13	CSB	Input	Serial Port Enable Input. Active low.
H13	SCLK	Input	Serial Plot Clock Input.
F13	SDIO	Input/output	Serial Port Bidirectional Data Input/Output.
J13	SDO	Output	Serial Port Data Output.
C12	RESETB	Input	Active Low Reset Input. RESETB places digital logic and SPI registers in a known default state. RESETB must be connected to a digital IC that is capable of issuing a reset signal for the first step in the device initialization process.
E13, D13	RXEN0, RXEN1	Input	Active High ADC and Receive Datapath Enable Inputs. RXENx is also SPI configurable.
P13, R13	TXEN0, TXEN1	Input	Active High DAC and Transmit Datapath Enable Inputs. TXENx is also SPI configurable.
D12, D11	ADC0_FD0, ADC0_FD1	Output	ADC0 Fast Detect Outputs by Default. Do not connect if unused.
E12, E11	ADC1_FD0, ADC1_FD1	Output	ADC1 Fast Detect Outputs by Default. Do not connect if unused.
F12, F11	ADC2_FD0, ADC2_FD1	Output	ADC2 Fast Detect Outputs by Default. Do not connect if unused.
G12, G11	ADC3_FD0, ADC3_FD1	Output	ADC3 Fast Detect Outputs by Default. Do not connect if unused.
P12, R12	IRQB_0, IRQB_1	Output	Interrupt Request Outputs. These pins are open-drain, active low outputs (CMOS levels with respect to DVDD1P8). Connect a >5 k $\Omega$ pull-up resistor to DVDD1P8 to prevent these pins from floating when unused.
N12, M12, N11, M11, P11, R11	GPIO0 to GPIO5	Input/output	General-Purpose Input or Output Pins. These pins control auxiliary functions related to the Tx datapaths.

## PIN CONFIGURATION AND FUNCTION DESCRIPTIONS

Table 21. Pin Function Descriptions

Pin No.	Mnemonic	Type	Description
N13, M13, L13, K13, T12	GPIO6 to GPIO10	Input/output	General-Purpose Input or Output Pins. These pins control auxiliary functions related to the Rx datapaths and ADCs.
JESD204B- or JESD204C-Compatible SERDES Data Lanes and Control Signals <sup>2</sup>			
L18, L17	SERDIN0+, SERDIN0-	Input	JRx Lane 0 Inputs, Data True/Complement.
N18, N17	SERDIN1+, SERDIN1-	Input	JRx Lane 1 Inputs, Data True/Complement.
R18, R17	SERDIN2+, SERDIN2-	Input	JRx Lane 2 Inputs, Data True/Complement.
U18, U17	SERDIN3+, SERDIN3-	Input	JRx Lane 3 Inputs, Data True/Complement.
M15, M14	SERDIN4+, SERDIN4-	Input	JRx Lane 4 Inputs, Data True/Complement.
V15, V14	SERDIN5+, SERDIN5-	Input	JRx Lane 5 Inputs, Data True/Complement.
T15, T14	SERDIN6+, SERDIN6-	Input	JRx Lane 6 Inputs, Data True/Complement.
P15, P14	SERDIN7+, SERDIN7-	Input	JRx Lane 7 Inputs, Data True/Complement.
U13, V13	SYNC0OUTB+, SYNC0OUTB-	Output	JRx Link 0 Synchronization Outputs for JESD204B interface. These pins are LVDS or CMOS configurable. These pins can also provide differential 100 $\Omega$ output impedance in LVDS mode.
U12, V12	SYNC1OUTB+, SYNC1OUTB-	Output	JRx Link 1 Synchronization Outputs for JESD204B Interface or CMOS Input to Control the Transmit Fast Frequency Hopping (FFH) Feature. For JRx link synchronization, these pins can be configured as LVDS or CMOS outputs and can provide differential 100 $\Omega$ output impedance in LVDS mode.
A15, A14	SERDOUT0+, SERDOUT0-	Output	JTx Lane 0 Outputs, Data True/Complement.
C15, C14	SERDOUT1+, SERDOUT1-	Output	JTx Lane 1 Outputs, Data True/Complement.
E15, E14	SERDOUT2+, SERDOUT2-	Output	JTx Lane 2 Outputs, Data True/Complement.
G15, G14	SERDOUT3+, SERDOUT3-	Output	JTx Lane 3 Outputs, Data True/Complement.
H18, H17	SERDOUT4+, SERDOUT4-	Output	JTx Lane 4 Outputs, Data True/Complement.
F18, F17	SERDOUT5+, SERDOUT5-	Output	JTx Lane 5 Outputs, Data True/Complement.
D18, D17	SERDOUT6+, SERDOUT6-	Output	JTx Lane 6 Outputs, Data True/Complement.
B18, B17	SERDOUT7+, SERDOUT7-	Output	JTx Lane 7 Outputs, Data True/Complement.
B13, A13	SYNC0INB+, SYNC0INB-	Input	JTx Link 0 Synchronization Inputs for JESD204B interface. These pins are LVDS or CMOS configurable and have selectable internal 100 $\Omega$ input impedance for LVDS operation.
B12, A12	SYNC1INB+, SYNC1INB-	Input	JTx Link 1 Synchronization Inputs for JESD204B interface or CMOS Inputs for Receive FFH via GPIOx pins. These pins are LVDS or CMOS configurable and have selectable internal 100 $\Omega$ input impedance for LVDS operation.
T4, T3	SYSREFP, SYSREFN	Input	Active High JESD204B/C System Reference Inputs. These pins are configurable for differential current mode logic (CML), PECL, and LVDS with internal 100 $\Omega$ termination or single-ended CMOS.



**PIN CONFIGURATION AND FUNCTION DESCRIPTIONS****Table 21. Pin Function Descriptions**

Pin No.	Mnemonic	Type	Description
No Connects and Do Not Connects			
J6, K6	NC	NC	No Connect. These pins can be left open or connected.
H4, L4, L15, L16	DNC	DNC	Do Not Connect. The pins must be kept open.

<sup>1</sup> CMOS inputs do not have pull-up or pull-down resistors.

<sup>2</sup> SERDINx± and SERDOUTx± include 100 Ω internal termination resistors.

TYPICAL PERFORMANCE CHARACTERISTICS

DAC

The data curves represent the average performance across all outputs with harmonics and spurs falling in the first Nyquist zone ( $< f_{DAC}/2$ ). All SFDR, IMD3, and NSD data measured on a laboratory evaluation board. All data for phase noise and ACLR is measured on the AD9081-FMCA-EBZ or the AD9082-FMCA-EBZ customer evaluation board. For additional information on the JESD204B and JESD204C mode configurations see the [UG-1578](#) user guide.

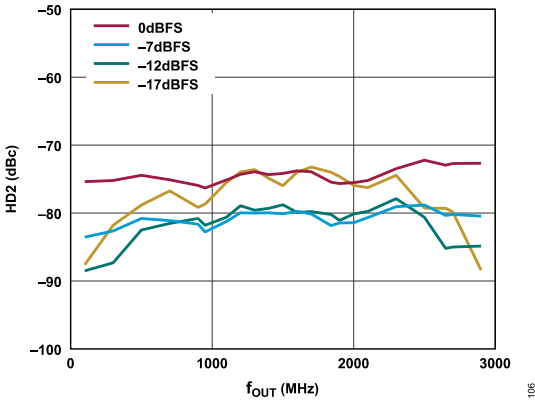

Figure 6. HD2 vs.  $f_{OUT}$  over Digital Scale, 6 GSPS DAC Sample Rate, Channel Interpolation 1x, Main Interpolation 4x, Mode 15C

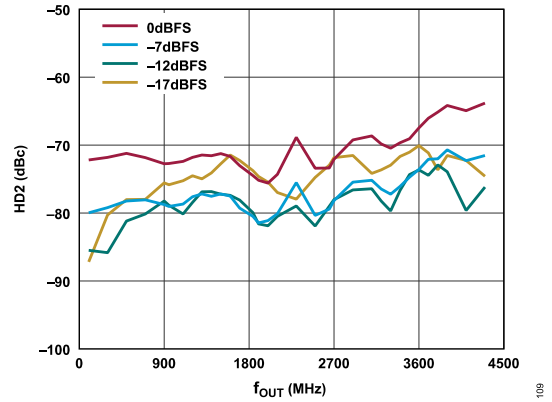

Figure 9. HD2 vs.  $f_{OUT}$  over Digital Scale, 9 GSPS DAC Sample Rate, Channel Interpolation 1x, Main Interpolation 6x, Mode 15C

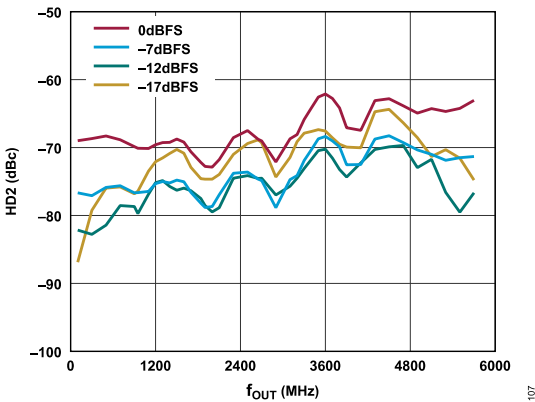

Figure 7. HD2 vs.  $f_{OUT}$  over Digital Scale, 12 GSPS DAC Sample Rate, Channel Interpolation 1x, Main Interpolation 8x, Mode 15C

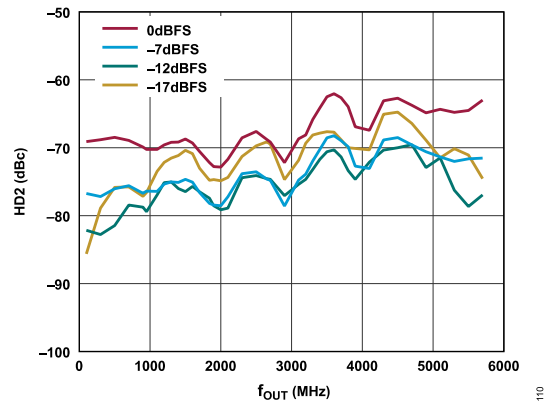

Figure 10. HD2 vs.  $f_{OUT}$  over Digital Scale, 12 GSPS DAC Sample Rate, Channel Interpolation 4x, Main Interpolation 8x, Mode 16B

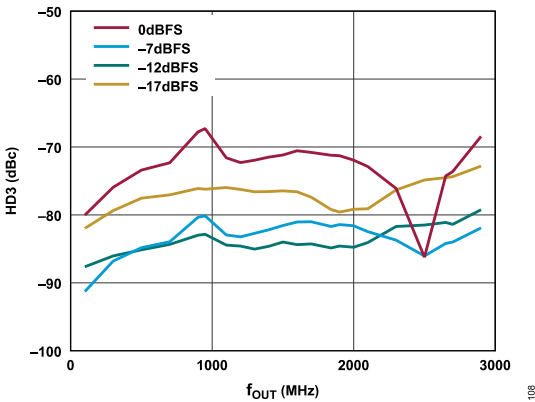

Figure 8. HD3 vs.  $f_{OUT}$  over Digital Scale, 6 GSPS DAC Sample Rate, Channel Interpolation 1x, Main Interpolation 4x, Mode 15C

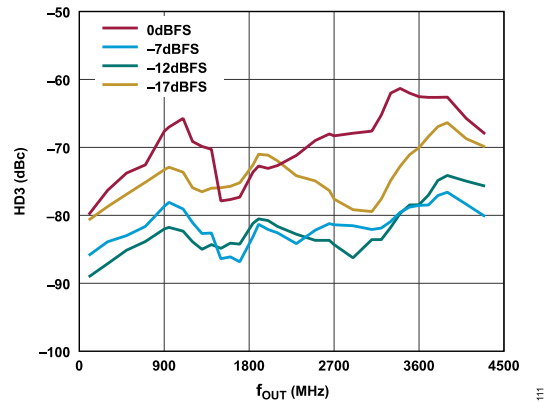

Figure 11. HD3 vs.  $f_{OUT}$  over Digital Scale, 9 GSPS DAC Sample Rate, Channel Interpolation 1x, Main Interpolation 6x, Mode 15C

TYPICAL PERFORMANCE CHARACTERISTICS

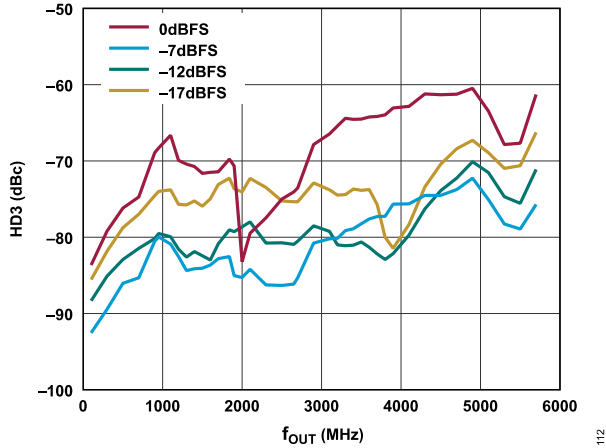

Figure 12. HD3 vs.  $f_{OUT}$  over Digital Scale, 12 GSPS DAC Sample Rate, Channel Interpolation 1x, Main Interpolation 8x, Mode 15C

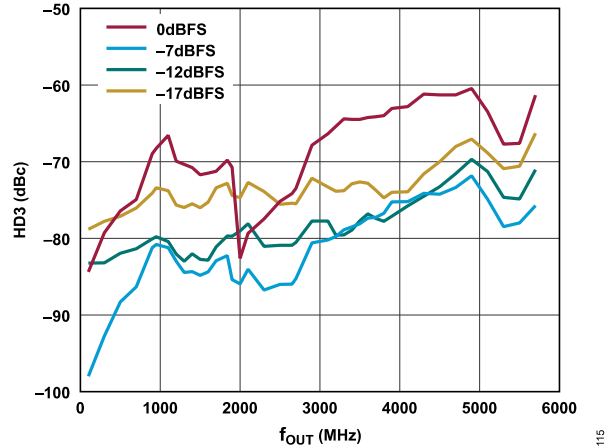

Figure 15. HD3 vs.  $f_{OUT}$  over Digital Scale, 12 GSPS DAC Sample Rate, Channel Interpolation 4x, Main Interpolation 8x, Mode 16B

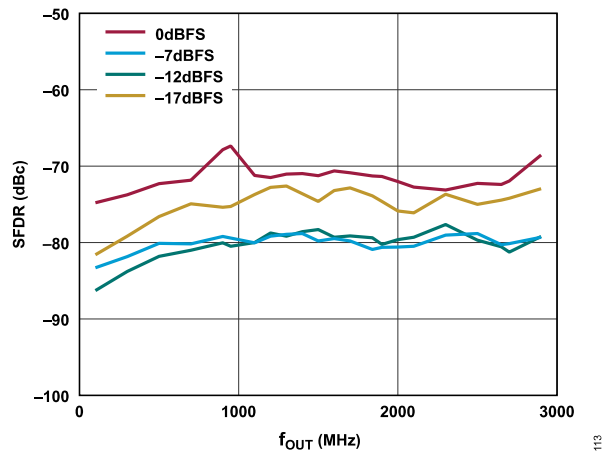

Figure 13. SFDR, Worst Spurious vs.  $f_{OUT}$  over Digital Scale, 6 GSPS DAC Sample Rate, Channel Interpolation 1x, Main Interpolation 4x, Mode 15C

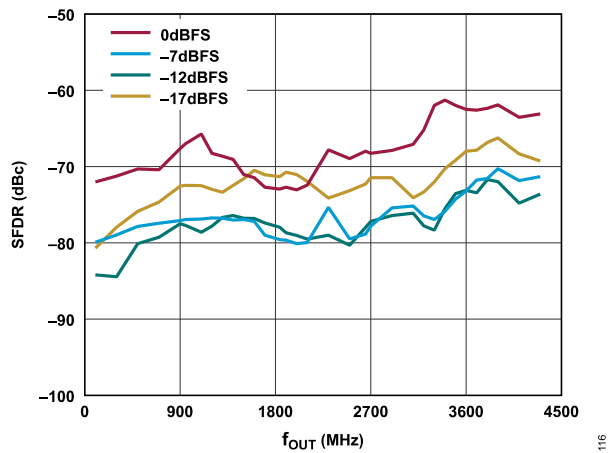

Figure 16. SFDR, Worst Spurious vs.  $f_{OUT}$  over Digital Scale, 9 GSPS DAC Sample Rate, Channel Interpolation 1x, Main Interpolation 6x, Mode 15C

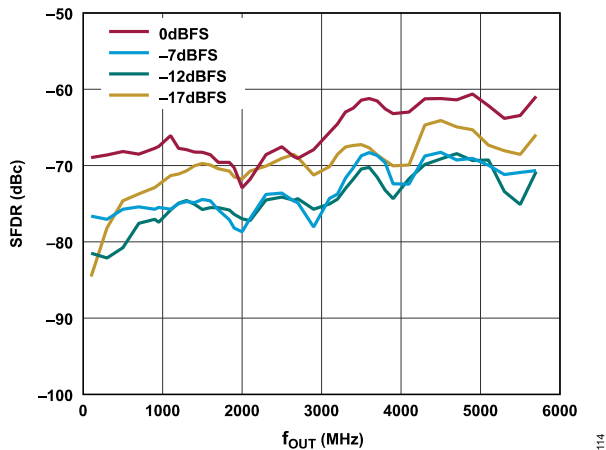

Figure 14. SFDR, Worst Spurious vs.  $f_{OUT}$  over Digital Scale, 12 GSPS DAC Sample Rate, Channel Interpolation 1x, Main Interpolation 8x, Mode 15C

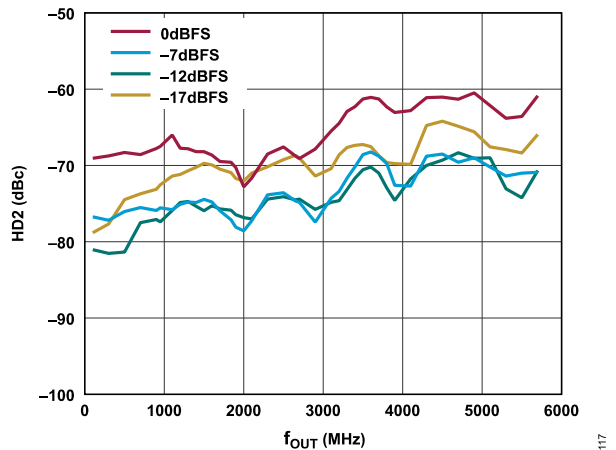

Figure 17. SFDR, Worst Spurious vs.  $f_{OUT}$  over Digital Scale, 12 GSPS DAC Sample Rate, Channel Interpolation 4x, Main Interpolation 8x, Mode 16B

TYPICAL PERFORMANCE CHARACTERISTICS

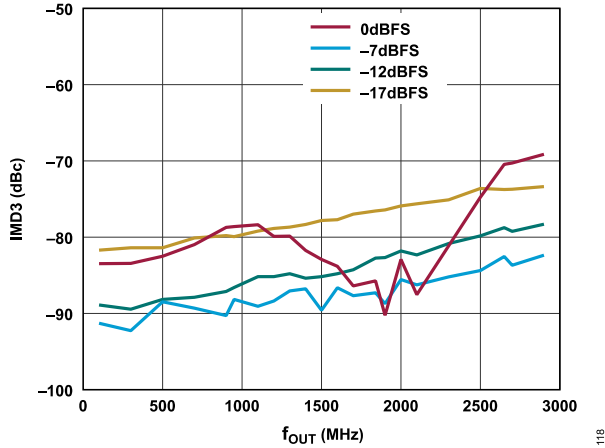

Figure 18. IMD3 vs.  $f_{OUT}$  over Digital Scale (Mode 17B), 6 GSPS DAC Sample Rate, Channel Interpolation 1x, Main Interpolation 4x, Mode 15C; IMD3 is a Two-Tone Test, and the Scale per Tone is 6 dB Lower than the Reported Digital Scale

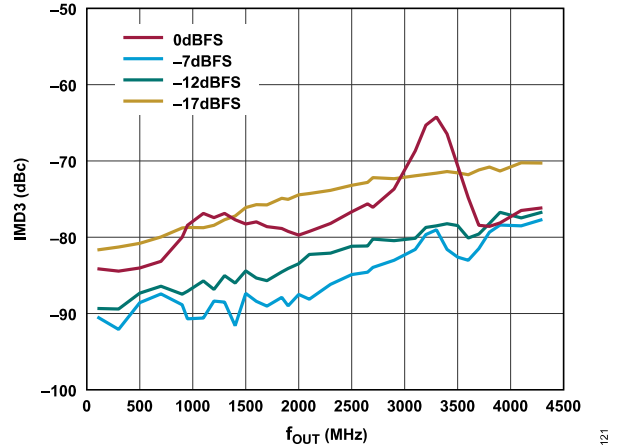

Figure 21. IMD3 vs.  $f_{OUT}$  over Digital Scale, 9 GSPS DAC Sample Rate, Channel Interpolation 1x, Main Interpolation 6x, Mode 15C; IMD3 is a Two-Tone Test, and the Scale per Tone is 6 dB Lower than the Reported Digital Scale

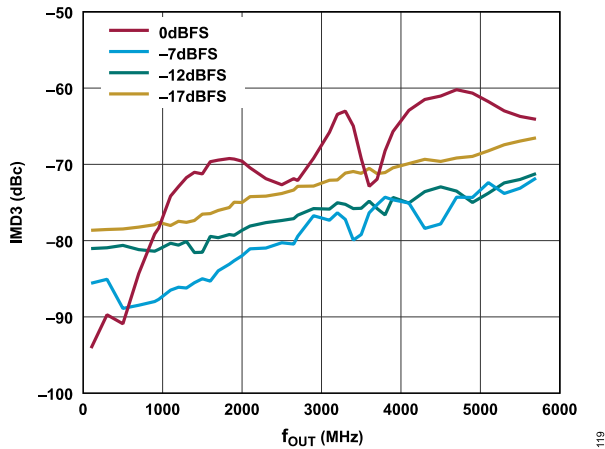

Figure 19. IMD3 vs.  $f_{OUT}$  over Digital Scale, 12 GSPS DAC Sample Rate, Channel Interpolation 1x, Main Interpolation 8x, Mode 15C; IMD3 is a Two-Tone Test, and the Scale per Tone is 6 dB Lower than the Reported Digital Scale

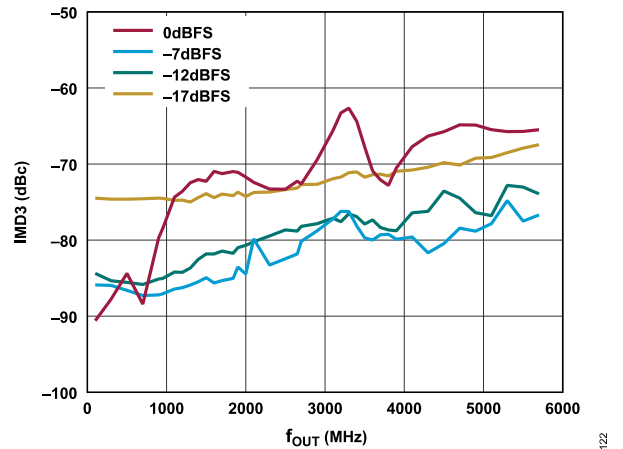

Figure 22. IMD3 vs.  $f_{OUT}$  over Digital Scale, 12 GSPS DAC Sample Rate, Channel Interpolation 4x, Main Interpolation 8x, Mode 16B; IMD3 is a Two-Tone Test, and the Scale per Tone is 6 dB Lower than the Reported Digital Scale

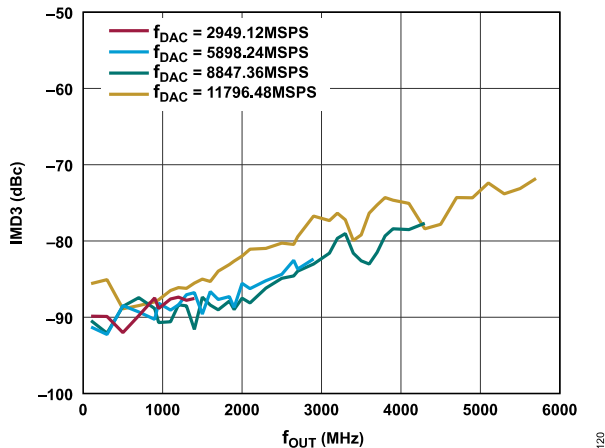

Figure 20. IMD3 vs.  $f_{OUT}$  over  $f_{DAC}$ , Digital Scale -7 dBFS; IMD3 is a Two-Tone Test, and the Scale per Tone is 6 dB Lower than the Reported Digital Scale

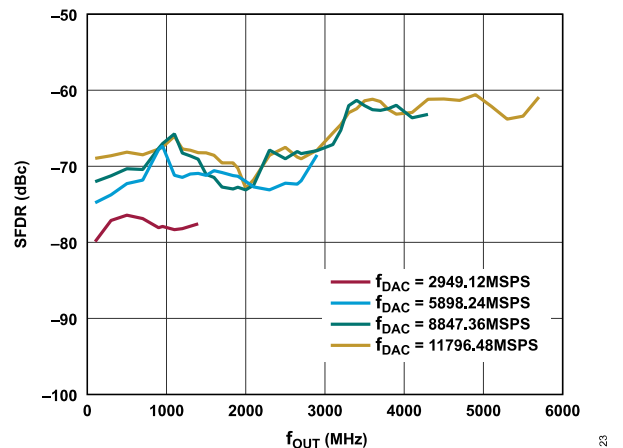

Figure 23. SFDR, Worst In-Band Spurious vs.  $f_{OUT}$  over  $f_{DAC}$ , with 0 dBFS Tone Level

TYPICAL PERFORMANCE CHARACTERISTICS

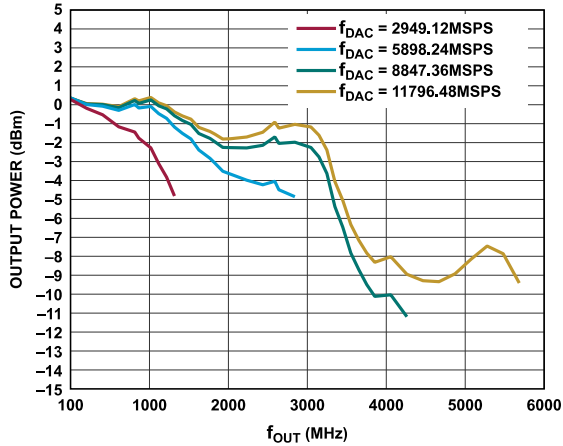

Figure 24. DAC0 Fundamental Output Power vs.  $f_{OUT}$  Across  $f_{DAC}$ , at 0 dBFS Digital Back Off, Measured on a Laboratory Evaluation Board; the AD9081-FMCA-EBZ or AD9082-FMCA-EBZ Evaluation Board has a Different PCB Layout and Results in a Different Frequency Response when Compared to a Laboratory Evaluation Board

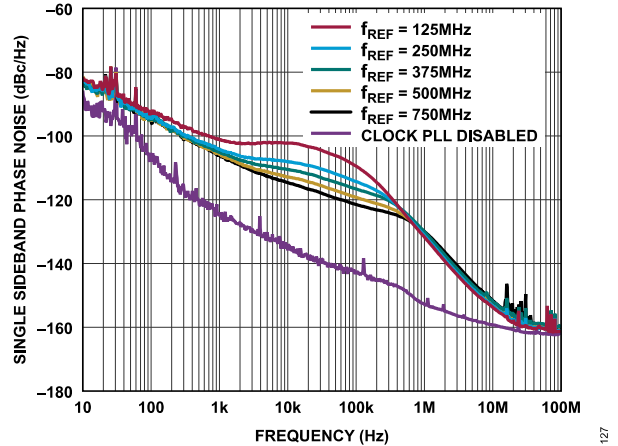

Figure 27. Single Sideband Phase Noise vs. Frequency Offset for Different PLL Reference Clocks ( $f_{REF}$ ),  $f_{OUT} = 1.8 \text{ GHz}$ ,  $f_{DAC} = 12 \text{ GSPS}$ , PLL Enabled with Exception of External 12 GHz Clock Input with Clock PLL Disabled

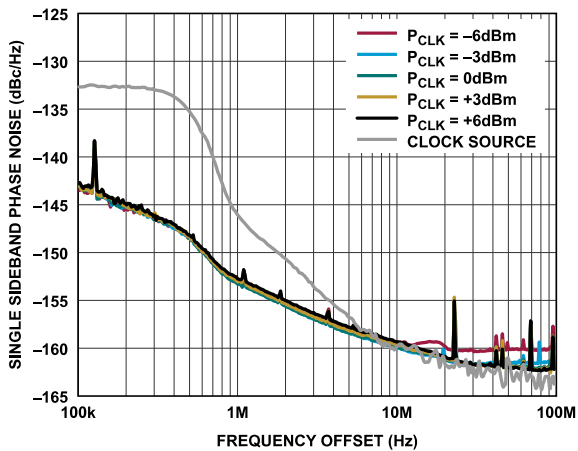

Figure 25. Single Sideband Phase Noise vs. Frequency Offset for Different Clock Input Power ( $P_{CLK}$ ),  $f_{OUT} = 1.8 \text{ GHz}$ , External 12 GHz Clock Input with Clock PLL Disabled

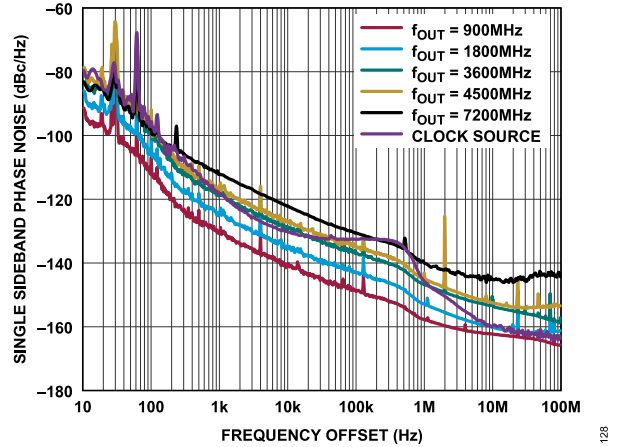

Figure 28. Single Sideband Phase Noise vs. Frequency Offset for Different DAC Output Frequencies ( $f_{OUT}$ ), External 12 GHz Clock Input with Clock PLL Disabled

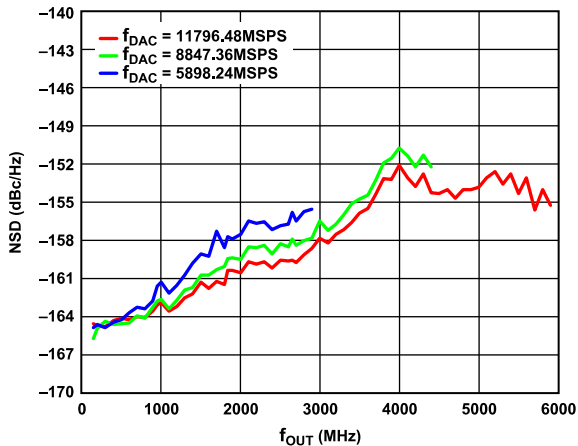

Figure 26. Single-Tone NSD Measured at 10% Offset from  $f_{OUT}$  vs.  $f_{OUT}$  over  $f_{DAC}$ , Shuffle On, 16-Bit Resolution, Mode 15C

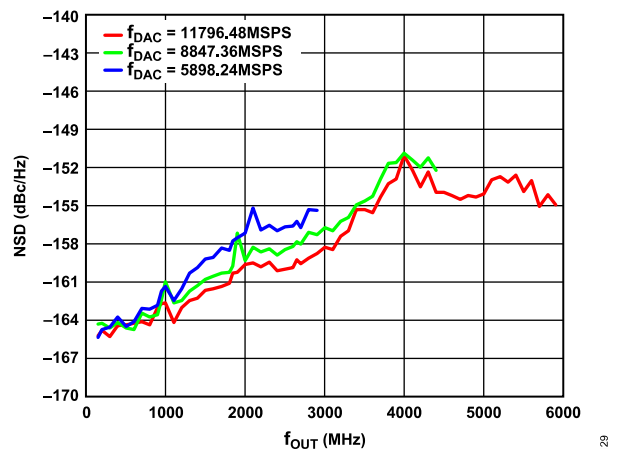

Figure 29. Single-Tone NSD Measured at 10% Offset from  $f_{OUT}$  vs.  $f_{OUT}$  over  $f_{DAC}$ , 12-Bit Resolution, Shuffle On, Mode 24C

TYPICAL PERFORMANCE CHARACTERISTICS

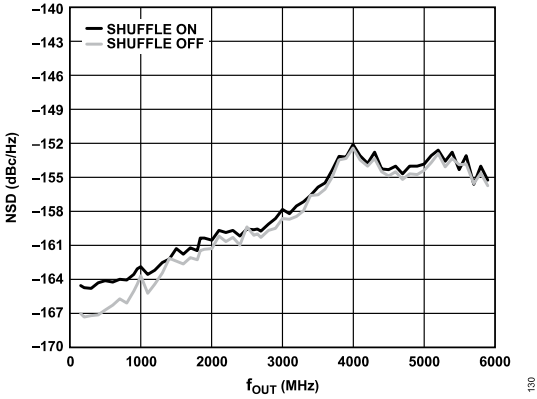

Figure 30. Single-Tone NSD Measured at 10% Offset from  $f_{OUT}$  vs.  $f_{OUT}$ , Shuffle Off vs. Shuffle On,  $f_{DAC} = 11796.48$  MSPS, 16-Bit Resolution, Mode 15C

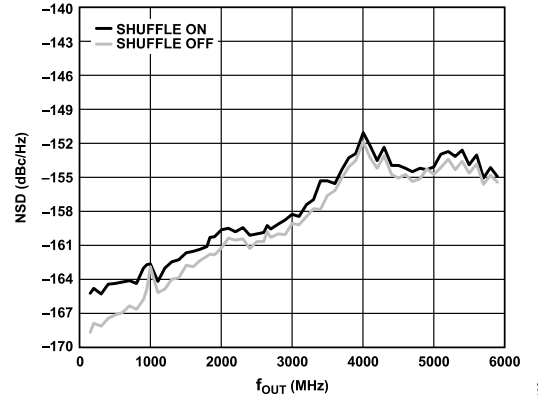

Figure 33. Single-Tone NSD Measured at 10% Offset from  $f_{OUT}$  vs.  $f_{OUT}$ , Shuffle Off vs. Shuffle On,  $f_{DAC} = 11796.48$  MSPS, 12-Bit Resolution, Mode 24C

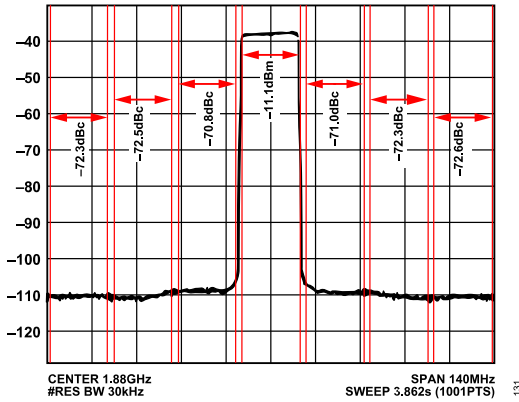

Figure 31. Dual Band ACLR Performance for Two 20 MHz LTE carriers at  $f_{OUT} = 1.88$  GHz and  $f_{OUT} = 2.145$  GHz refer to figure 32 for a wideband plot); Showing a Close Up of One Carrier at  $f_{OUT} = 1.88$  GHz,  $f_{DAC} = 11.796$  GSPS, Test Vector PAR = 7.7 dB with -1 dBFS Back Off, Channel Interpolation 3x, Main Interpolation 8x, Mode 9C

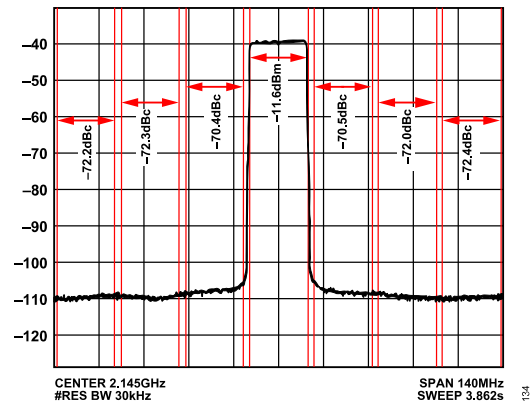

Figure 34. Dual Band ACLR Performance for two 20 MHz LTE carriers at  $f_{OUT} = 1.88$  GHz and  $f_{OUT} = 2.145$  GHz (Refer to Figure 32 for a Wideband Plot); Showing a Close-up of One Carrier at  $f_{OUT} = 2.145$  GHz,  $f_{DAC} = 11.796$  GSPS, Test Vector PAR = 7.7 dB with -1 dBFS Back Off, Channel Interpolation 3x, Main Interpolation 8x, Mode 9C

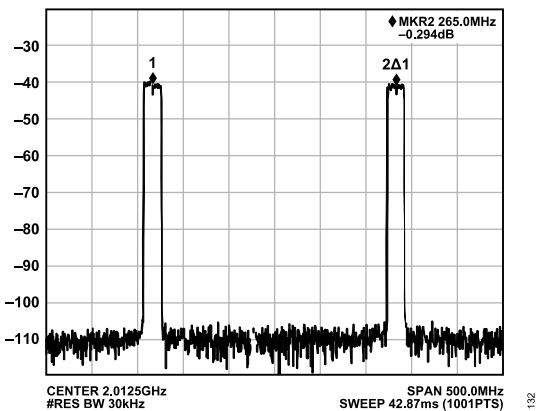

Figure 32. Dual Band Wideband Plot for Two 20 MHz LTE Carriers at  $f_{OUT} = 1.88$  GHz and  $f_{OUT} = 2.145$  GHz (3GPP Bands, B1 and B3, Respectively), at  $f_{DAC} = 11.796$  GSPS, Test Vector PAR = 7.7 dB with -1 dBFS Back Off, Channel Interpolation 3x, Main Interpolation 8x, Mode 9C

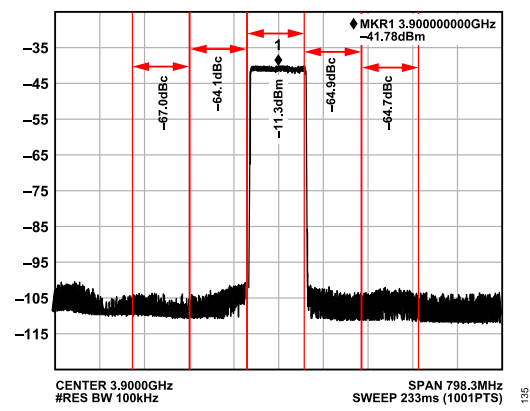

Figure 35. Adjacent Channel Leakage Ratio (ACLR) Performance for 100 MHz 5G Test Vector at  $f_{OUT} = 3.9$  GHz and  $f_{DAC} = 11.898$  GSPS, Test Vector Peak to RMS = 11.7 dB with -1 dBFS Back Off (Mode 9C), Channel Interpolation 3x, Main Interpolation 8x

TYPICAL PERFORMANCE CHARACTERISTICS

ADC

Nominal supplies, sampling rate (sample frequency ( $f_S$ ) or  $f_{ADC}$ ) = 3 GSPS with DAC clock frequency ( $f_{CLK}$ ) = 12 GHz, direct RF clock. The ADC datapath is configured for a complex I/Q data rate ( $f_{IQ\_DATA}$ ) = 1500 MSPS and decimation of 2x with NCO tuned to  $f_S/4$  ( $f_S/4$  means the same as  $f_{ADC}/4$ ). JTx mode of 16C (L = 8, M = 8, F = 2, S = 7, K = 128, E = 1, N = 16, NP = 16),  $T_J = 80^\circ\text{C}$  ( $T_A = 25^\circ\text{C}$ ), 128k FFT sample with five averages, and  $A_{IN} = -1$  dBFS, unless otherwise noted.

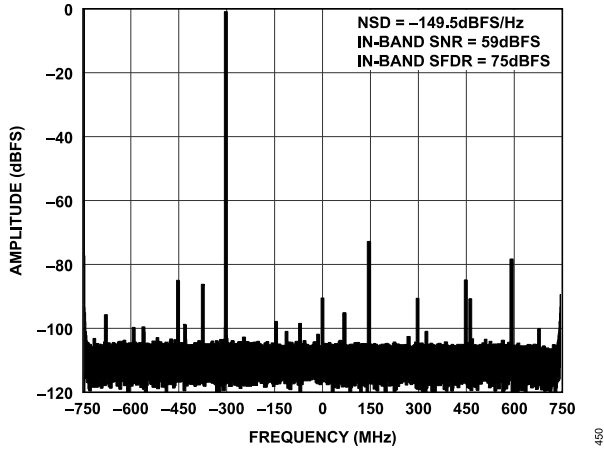

Figure 36. Single-Tone FFT at  $f_{IN} = 450$  MHz

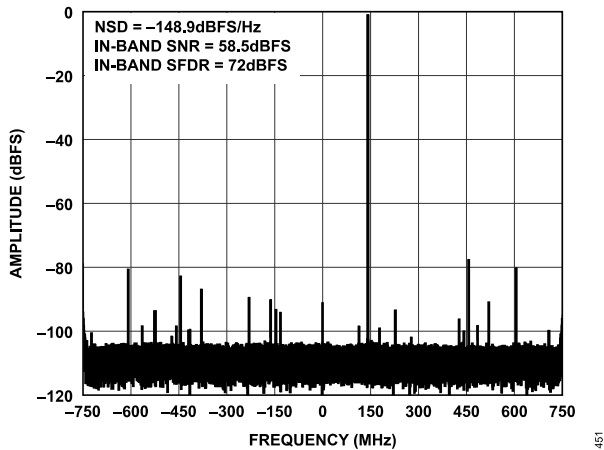

Figure 37. Single-Tone FFT at  $f_{IN} = 900$  MHz

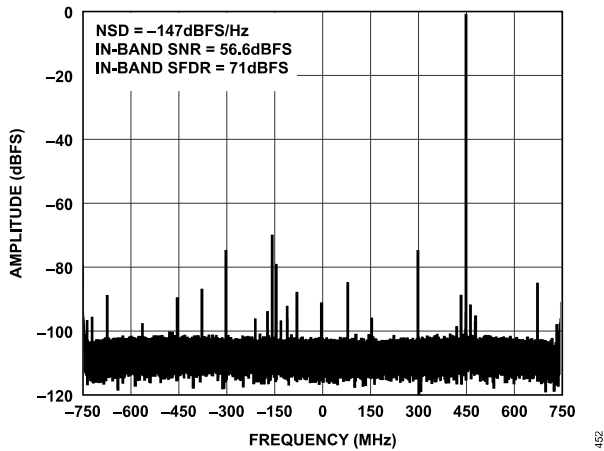

Figure 38. Single-Tone FFT at  $f_{IN} = 1800$  MHz

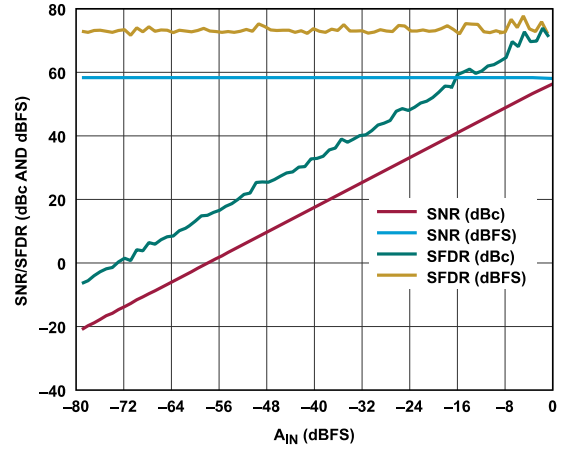

Figure 39. Single-Tone SFDR and SNR vs.  $A_{IN}$  at  $f_{IN} = 450$  MHz,  $f_S = 4$  GSPS

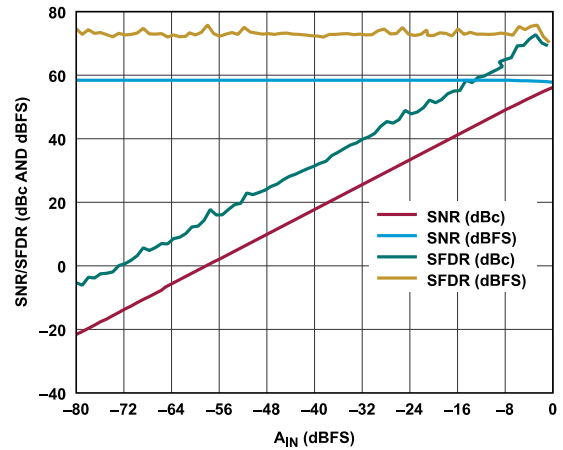

Figure 40. Single-Tone SFDR and SNR vs.  $A_{IN}$  at  $f_{IN} = 900$  MHz,  $f_S = 4$  GSPS

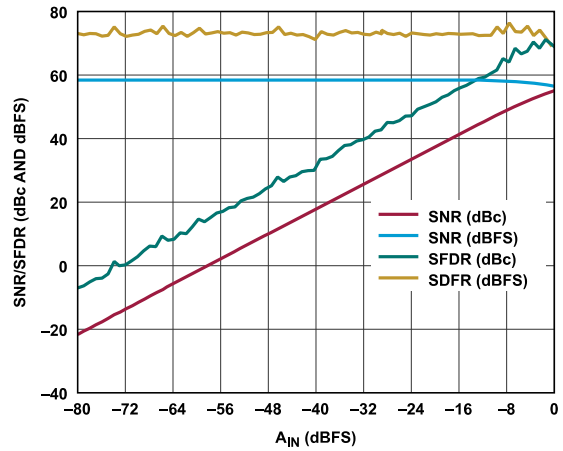

Figure 41. Single-Tone SFDR and SNR vs.  $A_{IN}$  at  $f_{IN} = 1800$  MHz,  $f_S = 4$  GSPS

TYPICAL PERFORMANCE CHARACTERISTICS

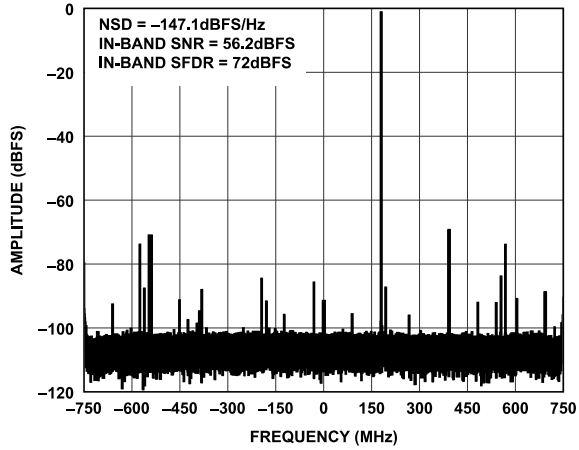

Figure 42. Single-Tone FFT at  $f_{IN} = 2700$  MHz

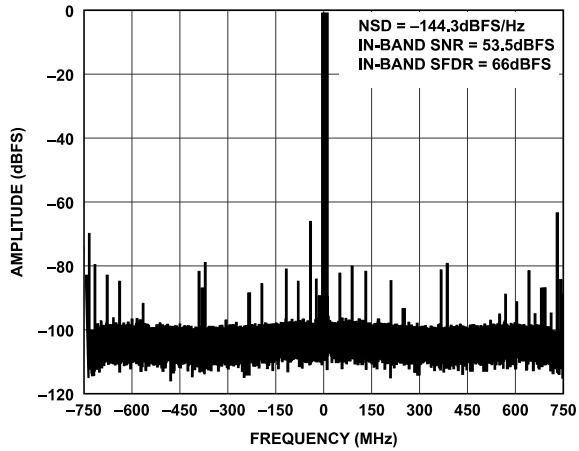

Figure 43. Single-Tone FFT at  $f_{IN} = 3600$  MHz

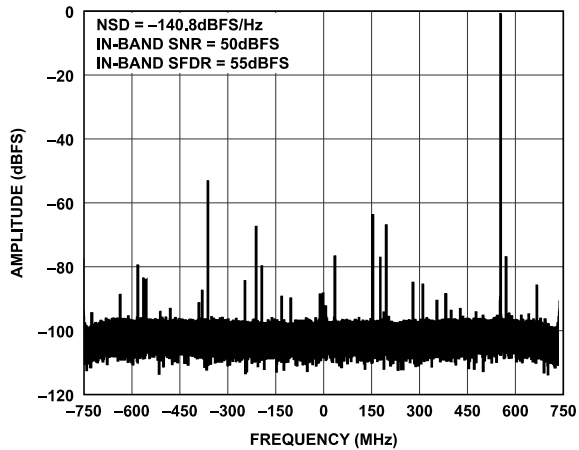

Figure 44. Single-Tone FFT at  $f_{IN} = 4700$  MHz

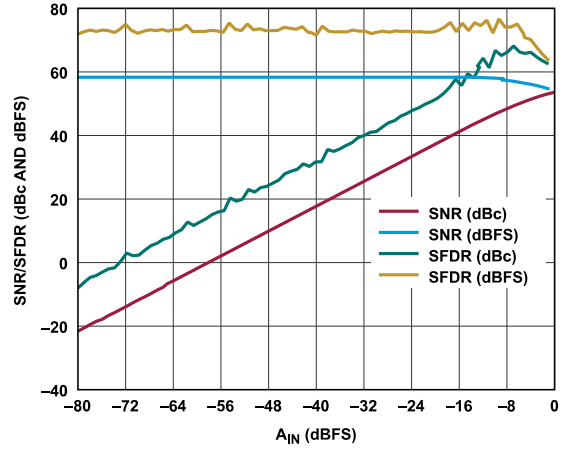

Figure 45. Single-Tone SFDR and SNR vs.  $A_{IN}$  at  $f_{IN} = 2700$  MHz,  $f_S = 4$  GSPS

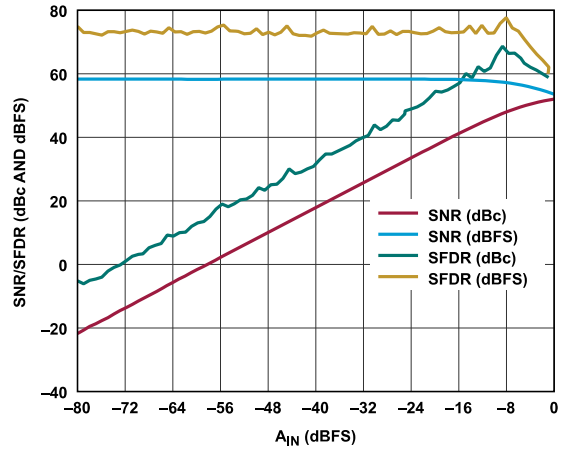

Figure 46. Single-Tone SFDR and SNR vs.  $A_{IN}$  at  $f_{IN} = 3600$  MHz,  $f_S = 4$  GSPS

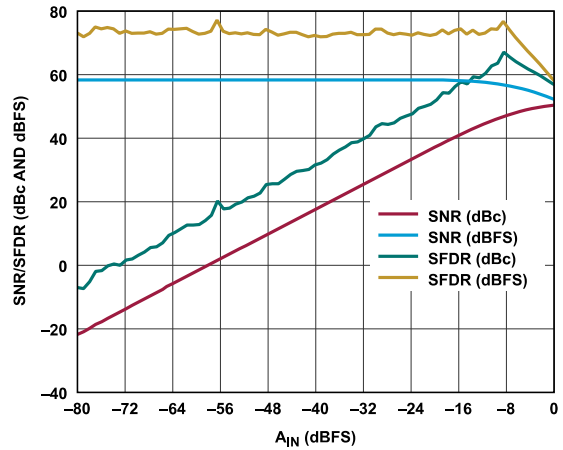

Figure 47. Single-Tone SFDR and SNR vs.  $A_{IN}$  at  $f_{IN} = 4500$  MHz,  $f_S = 4$  GSPS



TYPICAL PERFORMANCE CHARACTERISTICS

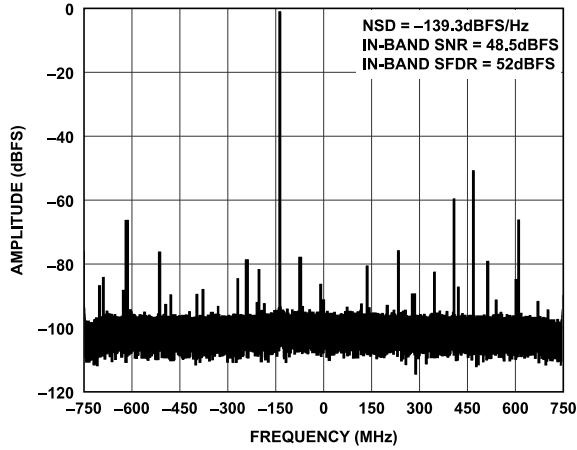

Figure 48. Single-Tone FFT at  $f_{IN} = 5400$  MHz

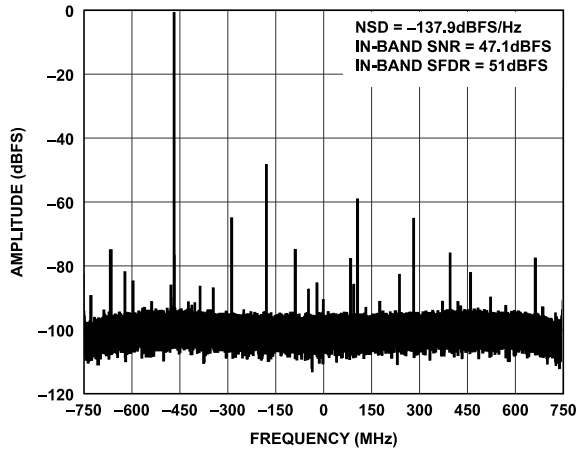

Figure 49. Single-Tone FFT at  $f_{IN} = 6300$  MHz

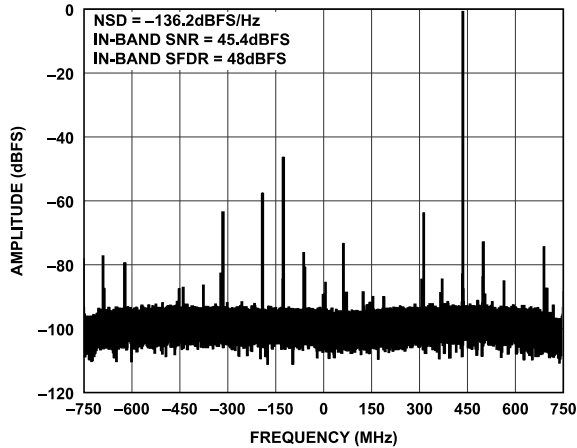

Figure 50. Single-Tone FFT at  $f_{IN} = 7200$  MHz

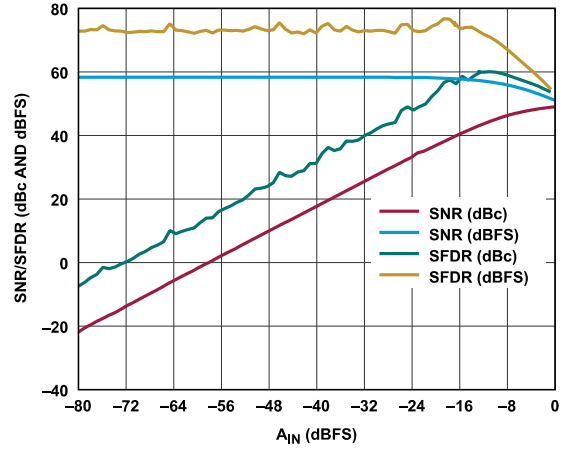

Figure 51. Single-Tone SFDR and SNR vs.  $A_{IN}$  at  $f_{IN} = 5400$  MHz,  $f_S = 4$  GSPS

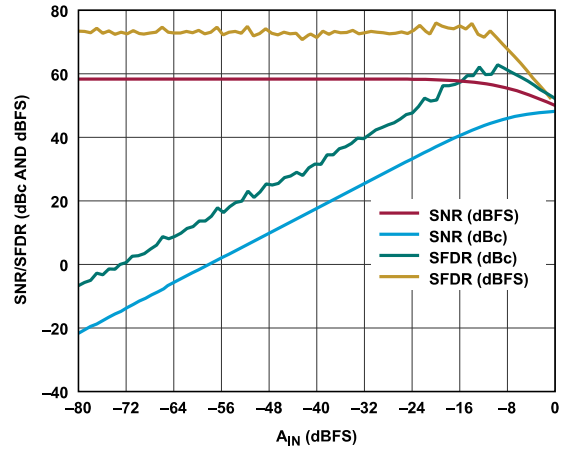

Figure 52. Single-Tone SFDR and SNR vs.  $A_{IN}$  at  $f_{IN} = 6300$  MHz,  $f_S = 4$  GSPS

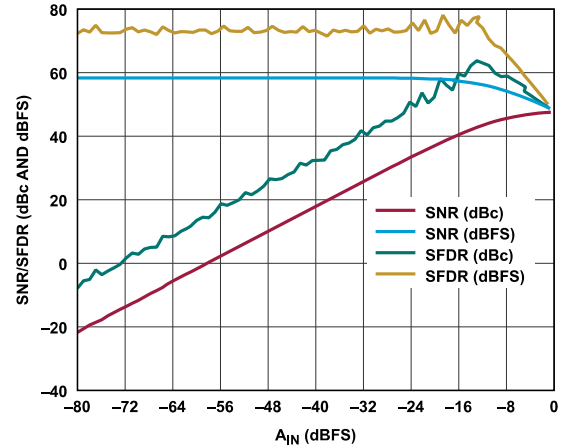

Figure 53. Single-Tone SFDR and SNR vs.  $A_{IN}$  at  $f_{IN} = 7200$  MHz,  $f_S = 4$  GSPS

TYPICAL PERFORMANCE CHARACTERISTICS

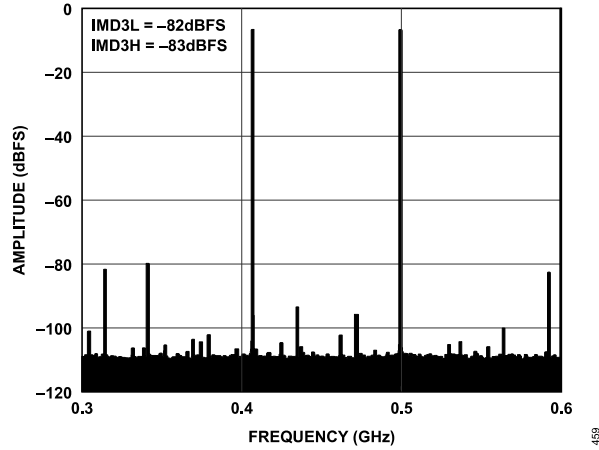

Figure 54. Two-Tone FFT,  $f_{IN1} = 1.775$  GHz,  $f_{IN2} = 1.825$  GHz,  $A_{IN1}$  and  $A_{IN2} = -7$  dBFS (IMD3L =  $2f_{IN1} - f_{IN2}$ , and  $IMD3H = 2f_{IN2} - f_{IN1}$ ; IMD3L and IMD3H Are the Lower and Higher IMD3 Product Components, Respectively)

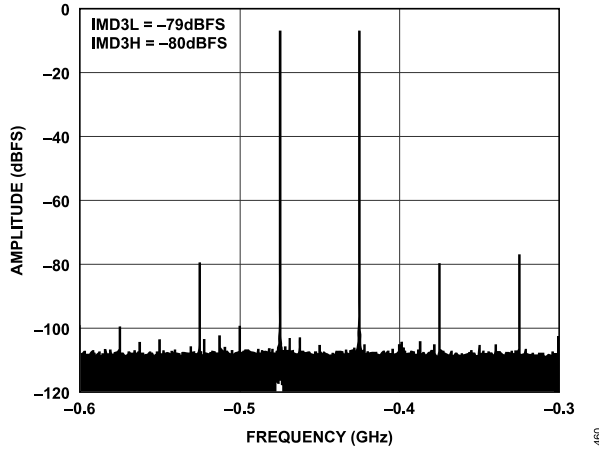

Figure 55. Two-Tone FFT,  $f_{IN1} = 2.675$  GHz,  $f_{IN2} = 2.725$  GHz,  $A_{IN1}$  and  $A_{IN2} = -7$  dBFS

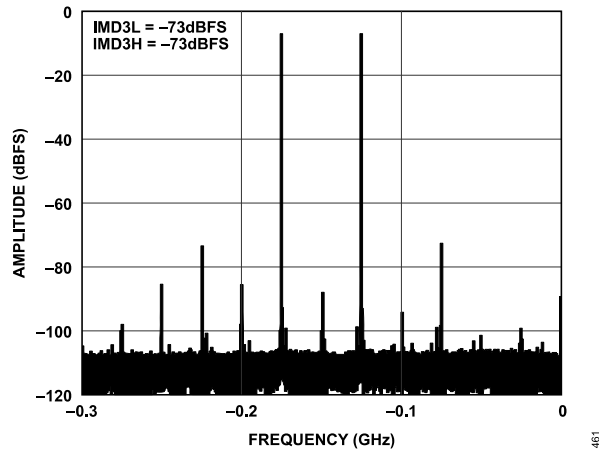

Figure 56. Two-Tone FFT,  $f_{IN1} = 3.575$  GHz,  $f_{IN2} = 3.625$  GHz,  $A_{IN1}$  and  $A_{IN2} = -7$  dBFS

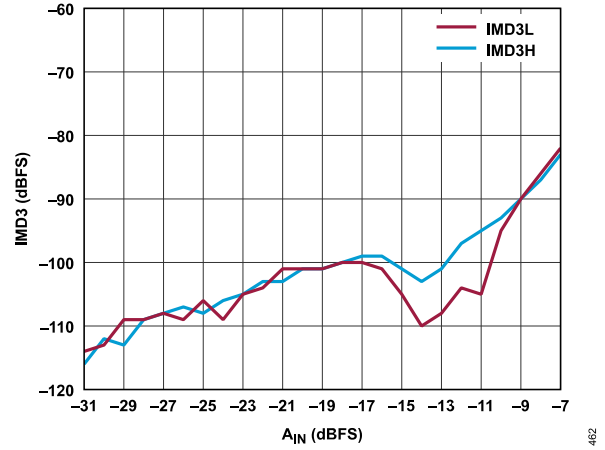

Figure 57. Two-Tone IMD3 vs.  $A_{IN}$  with  $f_{IN1} = 1.775$  GHz,  $f_{IN2} = 1.825$  GHz

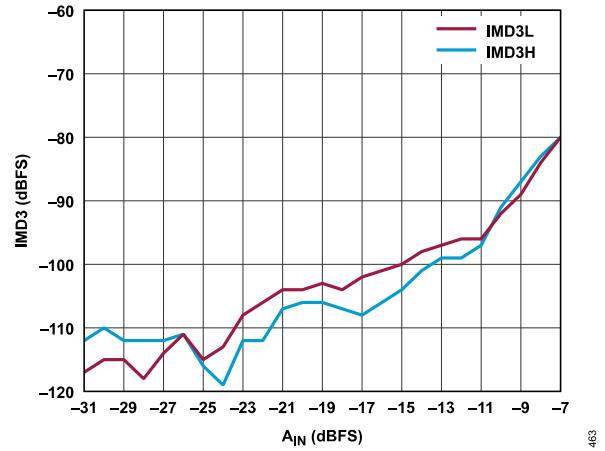

Figure 58. Two-Tone IMD3 vs.  $A_{IN}$  with  $f_{IN1} = 2.675$  GHz,  $f_{IN2} = 2.725$  GHz

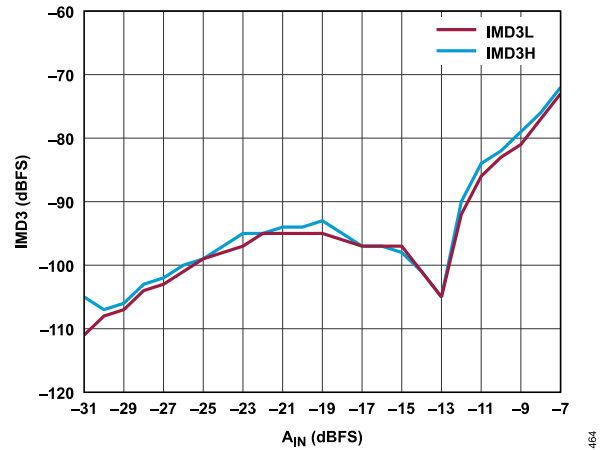

Figure 59. Two-Tone IMD3 vs.  $A_{IN}$  with  $f_{IN1} = 3.575$  GHz,  $f_{IN2} = 3.625$  GHz

TYPICAL PERFORMANCE CHARACTERISTICS

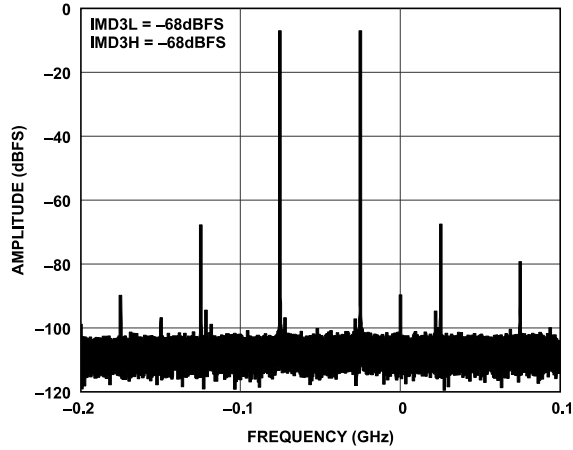

Figure 60. Two-Tone FFT,  $f_{IN1} = 5.375$  GHz,  $f_{IN2} = 5.425$  GHz,  $A_{IN1}$  and  $A_{IN2} = -7$  dBFS

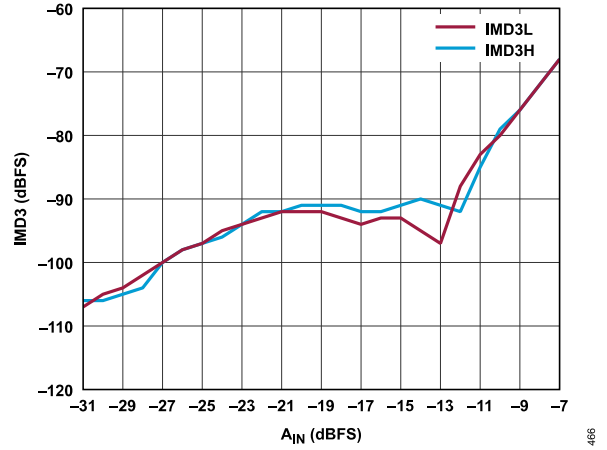

Figure 63. Two-Tone IMD3 vs.  $A_{IN}$  with  $f_{IN1} = 5.375$  GHz,  $f_{IN2} = 5.425$  GHz

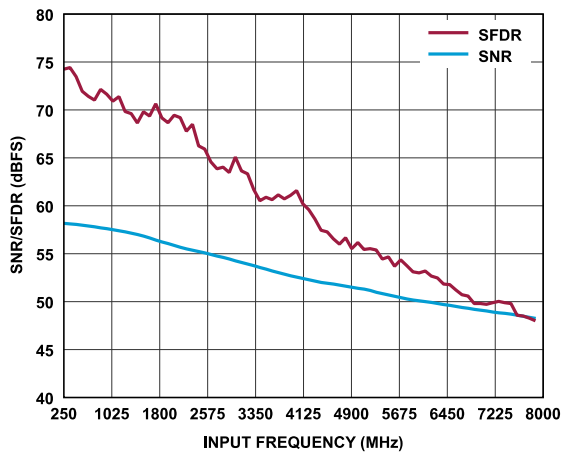

Figure 61. SNR and SFDR vs. Input Frequency with  $A_{IN} = -1$  dBFS,  $f_S = 4$  GSPS

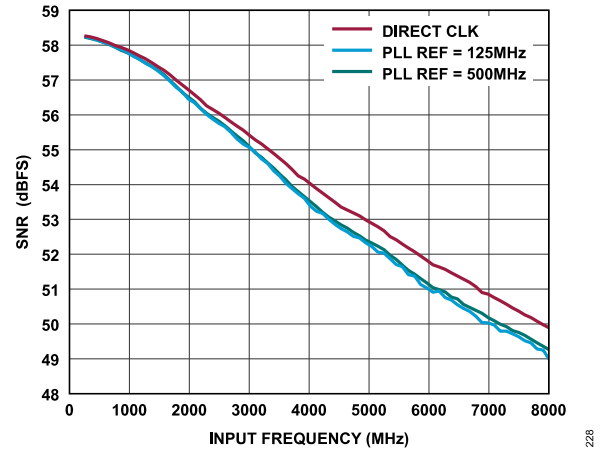

Figure 64. SNR vs. Input Frequency, Direct Clock vs. On-Chip PLL Clock,  $A_{IN} = -1$  dBFS,  $f_S = 4$  GSPS

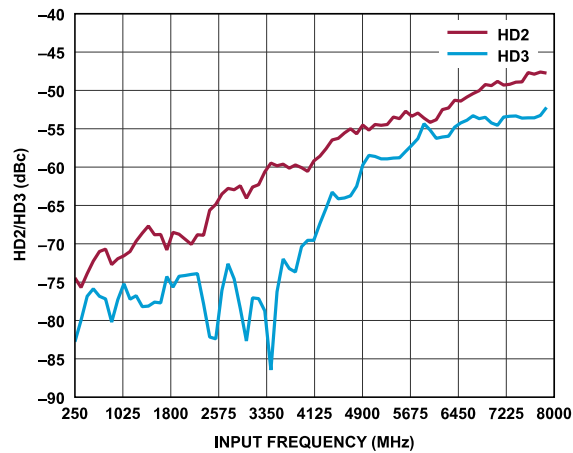

Figure 62. Harmonics (HD2 and HD3) vs. Input Frequency with  $A_{IN} = -1$  dBFS,  $f_S = 4$  GSPS

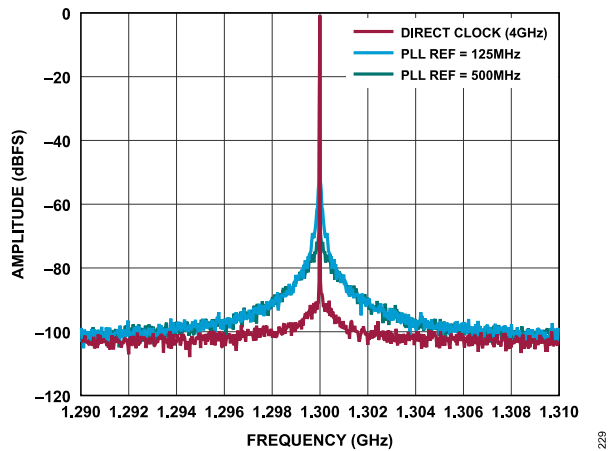

Figure 65. FFT Close-In Comparison, Direct Clock vs. On-Chip PLL Clock,  $f_{IN} = 2.7$  GHz,  $A_{IN} = -1$  dBFS,  $f_S = 4$  GSPS

TYPICAL PERFORMANCE CHARACTERISTICS

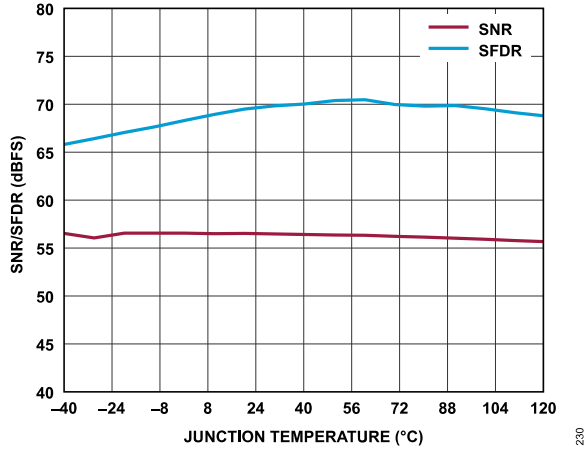

Figure 66. SNR and SFDR vs. Die Temperature,  $f_{IN} = 1.85 \text{ GHz}$ ,  $A_{IN} = -1 \text{ dBFS}$ ,  $f_S = 4 \text{ GSPS}$

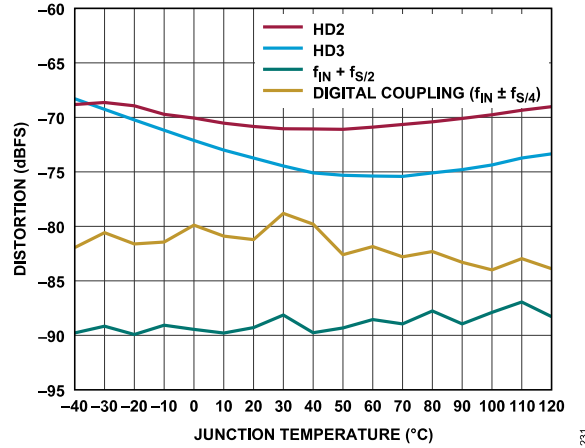

Figure 69. Harmonics (HD2, HD3, and Interleaving) vs. Junction Temperature,  $f_{IN} = 1.85 \text{ GHz}$ ,  $f_S = 4 \text{ GSPS}$

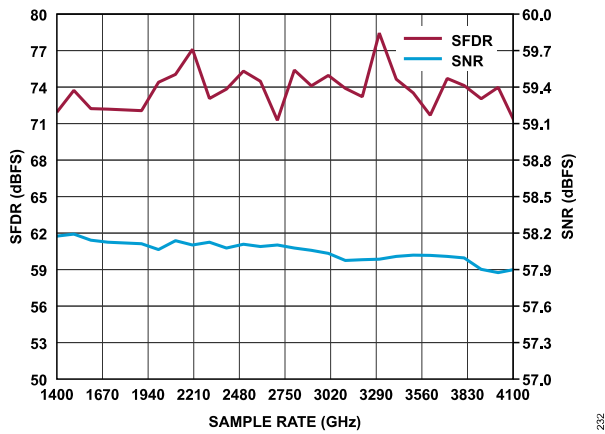

Figure 67. SNR and SFDR vs. Sample Frequency ( $f_S$ ),  $f_{IN} = 450 \text{ MHz}$ ,  $f_S = 4 \text{ GSPS}$

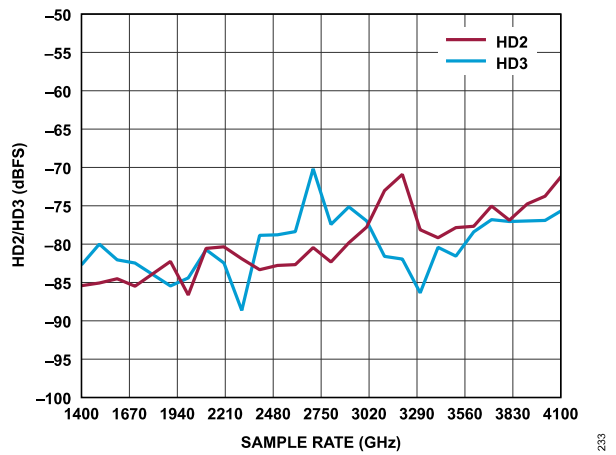

Figure 70. Harmonics (HD2 and HD3) vs. Sample Rate,  $f_{IN} = 450 \text{ MHz}$

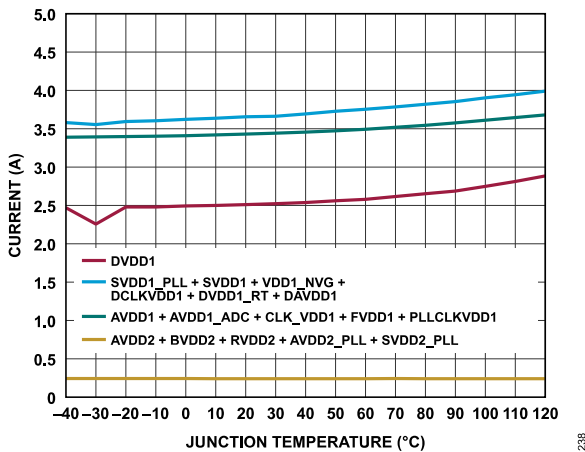

Figure 68. Power vs. Junction Temperature,  $f_{IN} = 1.85 \text{ GHz}$ ,  $A_{IN} = -1 \text{ dBFS}$ ,  $f_S = 4 \text{ GSPS}$

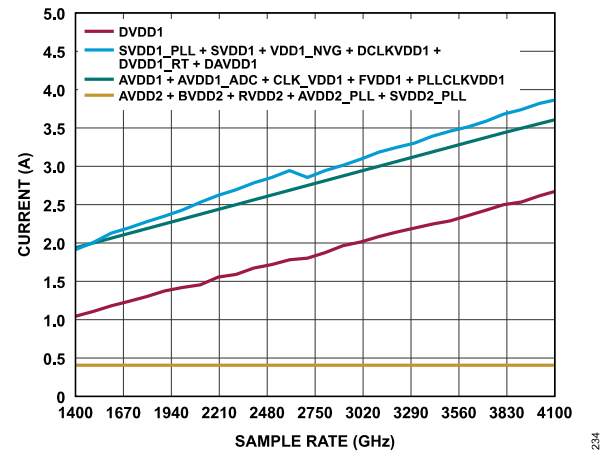

Figure 71. Power vs. Sample Rate,  $f_{IN} = 450 \text{ MHz}$

TYPICAL PERFORMANCE CHARACTERISTICS

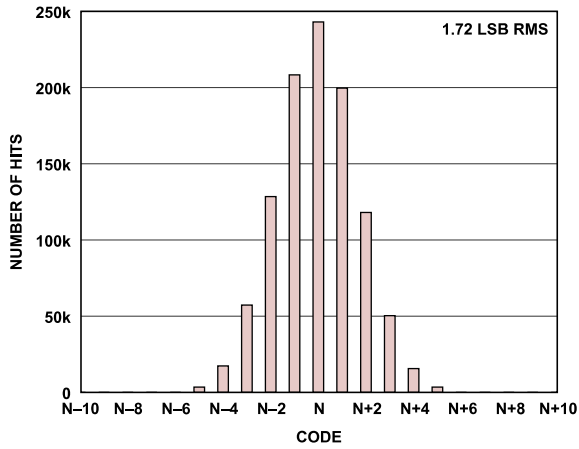

Figure 72. Input Referred Noise Histogram

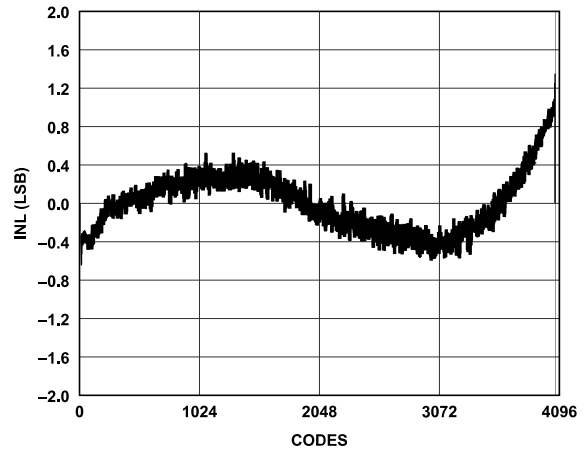

Figure 75. INL,  $f_{IN} = 255$  MHz

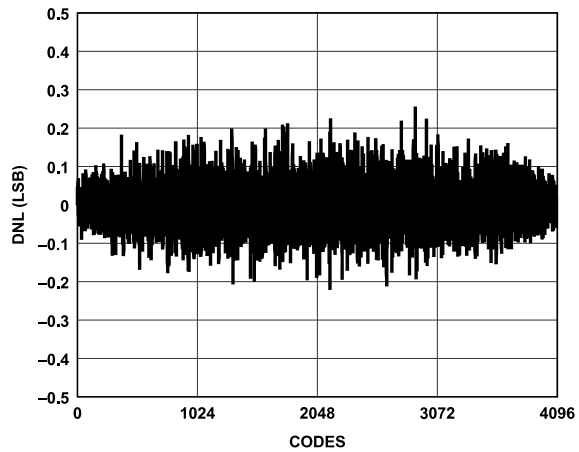

Figure 73. DNL,  $f_{IN} = 255$  MHz

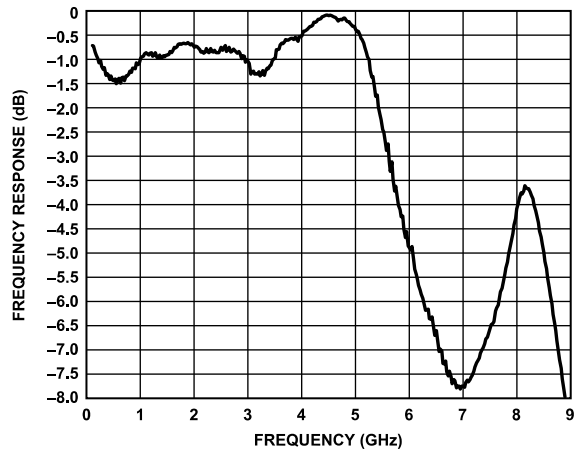

Figure 74. Measured Input Bandwidth ADC Input on AD9081-FMCA-EBZ (No Matching Network)

## THEORY OF OPERATION

The AD9988 is a highly integrated, mixed-signal, direct radio frequency (RF) sampling transceiver offering four transmitters and four receivers (4T4R) and digital signal processing (DSP) functions (see [Figure 1](#)). The device delivers a versatile combination of high performance, configurability, and low power consumption demanded by wireless infrastructure applications such as multiband macro 5G and mmWave 5G base station radios. The AD9988 also offers features to support the time division duplex (TDD) and the frequency division duplex (FDD) techniques.

The receive path consists of four pipelined, 12-bit, 4 GSPS rate, RF analog-to-digital converter (ADC) cores. The transmit path consists of four 16-bit, 12 GSPS maximum sample rate, RF digital-to-analog converter (DAC) cores. Both receive and transmit paths are designed and optimized to sample and synthesize signals up to 7.5 GHz, with maximum instantaneous bandwidths of up to 1.2 GHz with a sample resolution of 16 bits. The device also supports lower resolutions such as 12 bits and 8 bits to reduce the bit rate of the JESD204B/C link for applications that do not require the higher dynamic range a 16-bit resolution offers. The wide instantaneous bandwidth allows the chip to support multiple carrier bands or a single wide band within a single device. The combination of the direct RF conversion architecture relaxes the requirements of the RF filters when compared to traditional intermediate frequency (IF) receivers. Several auxiliary functions, such fast detect and signal monitor, a programmable finite impulse response (FIR) filter, trans-

mit downstream power amplifier protection, and general-purpose inputs/output (GPIO) control are also integrated.

The DAC and ADC cores use sampling clocks that originate from either an external clock source or an on-chip clock multiplier that consists of an integer PLL circuit and voltage-controlled oscillator (VCO).

The device features eight transmit and eight receive lanes, where each lane supports up to 24.75 Gbps JESD204C or up to 15.5 Gbps JESD204B as a single or a dual link. Multichip synchronization and deterministic latency are supported according to JESD204B/C Subclass 1. The JESD204B/C interface supports a wide range of setups depending on the interface bandwidth requirements of the custom application specific IC (ASIC) or field-programmable gate array (FPGA). Refer to [UG-1578](#), the device user guide, for more information on device features and operation.

The AD9988 has an on-chip thermal management unit (TMU) that can be used to measure die junction temperature as part of a thermal management solution to guarantee thermal stability during system operation. The device is controlled via a standard 4-wire serial port interface (SPI) with support for 3-wire SPI communications. A comprehensive set of power-down modes are included to minimize power consumption during system downtime. The AD9988 is packaged in a 15 mm × 15 mm, 324-ball, thermally enhanced, ball grid array (BGA\_ED).

**APPLICATIONS INFORMATION**

Refer to [UG-1578](#), the device user guide, for more information on device initialization and other Applications Information.

OUTLINE DIMENSIONS

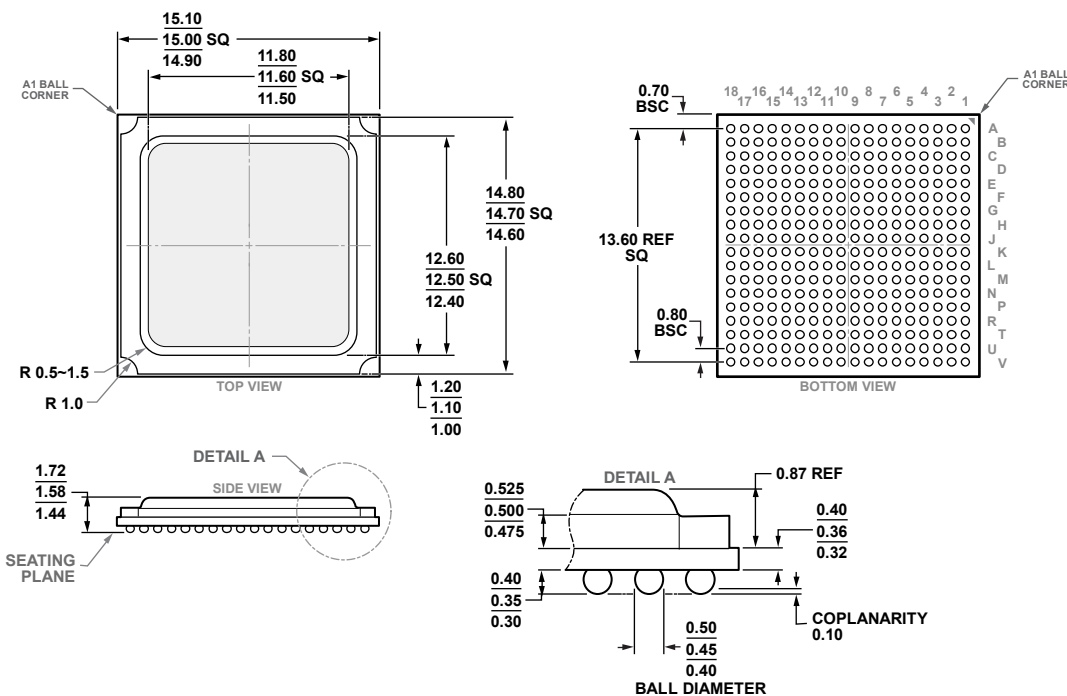

COMPLIANT TO JEDEC STANDARDS MO-275-KKAB-1

Figure 76. 324-Ball Ball Grid Array, Thermally Enhanced [BGA\_ED]  
(BP-324-3)  
Dimensions shown in millimeters

ORDERING GUIDE

Model <sup>1</sup>	Temperature Range <sup>2</sup>	Package Description	Ordering Quantity	Package Option
AD9988BBPZ-4D4AC	-40°C to +120°C	324-Ball BGA_ED	Tray, 126	BP-324-3
AD9988BBPZRL-4D4AC	-40°C to +120°C	324-Ball BGA_ED	Reel, 1000	BP-324-3

<sup>1</sup> Z = RoHS Compliant Part.

<sup>2</sup> Specified operating junction temperature (T<sub>j</sub>).

EVALUATION BOARDS

Model	Description
AD9988-FMCB-EBZ	AD9988 Evaluation Board