

# NTB150N65S3HF

## MOSFET – N-Channel, SUPERFET III, FRFET

**650 V, 24 A, 150 mΩ**

### Description

SUPERFET III MOSFET is ON Semiconductor's brand-new high voltage super-junction (SJ) MOSFET family that is utilizing charge balance technology for outstanding low on-resistance and lower gate charge performance. This advanced technology is tailored to minimize conduction loss, provide superior switching performance, and withstand extreme dv/dt rate.

Consequently, SUPERFET III MOSFET is very suitable for the various power systems for miniaturization and higher efficiency. SUPERFET III FRFET MOSFET's optimized reverse recovery performance of body diode can remove additional component and improve system reliability.

### Features

- 700 V @  $T_J = 150^\circ\text{C}$
- Typ.  $R_{DS(on)} = 121\text{ m}\Omega$
- Ultra Low Gate Charge (Typ.  $Q_g = 43\text{ nC}$ )
- Low Effective Output Capacitance (Typ.  $C_{oss(eff.)} = 400\text{ pF}$ )
- 100% Avalanche Tested
- These Devices are Pb-Free and are RoHS Compliant

### Applications

- Telecom / Server Power Supplies
- Industrial Power Supplies
- EV Charger
- UPS / Solar



**ON Semiconductor®**

[www.onsemi.com](http://www.onsemi.com)

$V_{DSS}$	$R_{DS(on)}\text{ MAX}$	$I_D\text{ MAX}$
650 V	150 mΩ @ 10 V	24 A

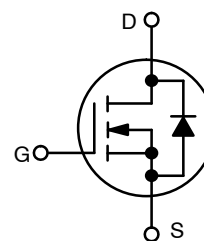

**N-CHANNEL MOSFET**

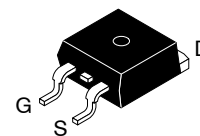

**D<sup>2</sup>PAK  
(TO-263 3-Lead)  
CASE 418AJ**

### MARKING DIAGRAM

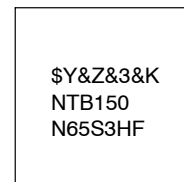

\$Y = ON Semiconductor Logo  
&Z = Assembly Plant Code  
&3 = Data Code (Year & Week)  
&K = Lot  
NTB150N65S3HF = Specific Device Code

### ORDERING INFORMATION

See detailed ordering and shipping information on page 2 of this data sheet.

# NTB150N65S3HF

## ABSOLUTE MAXIMUM RATINGS (T<sub>C</sub> = 25°C, Unless otherwise noted)

Symbol	Parameter	Value	Unit
V <sub>DSS</sub>	Drain to Source Voltage	650	V
V <sub>GSS</sub>	Gate to Source Voltage	- DC	±30
		- AC (f > 1 Hz)	±30
I <sub>D</sub>	Drain Current	- Continuous (T <sub>C</sub> = 25°C)	24
		- Continuous (T <sub>C</sub> = 100°C)	15.2
I <sub>DM</sub>	Drain Current	- Pulsed (Note 1)	60
E <sub>AS</sub>	Single Pulsed Avalanche Energy (Note 2)	275	mJ
I <sub>AS</sub>	Avalanche Current (Note 2)	3.8	A
E <sub>AR</sub>	Repetitive Avalanche Energy (Note 1)	1.92	mJ
dv/dt	MOSFET dv/dt	100	V/ns
	Peak Diode Recovery dv/dt (Note 3)	50	
P <sub>D</sub>	Power Dissipation	(T <sub>C</sub> = 25°C)	192
		- Derate Above 25°C	1.54
T <sub>J</sub> , T <sub>STG</sub>	Operating and Storage Temperature Range	-55 to +150	°C
T <sub>L</sub>	Maximum Lead Temperature for Soldering, 1/8" from Case for 5 seconds	300	°C

Stresses exceeding those listed in the Maximum Ratings table may damage the device. If any of these limits are exceeded, device functionality should not be assumed, damage may occur and reliability may be affected.

1. Repetitive rating: pulse-width limited by maximum junction temperature.
2. I<sub>AS</sub> = 3.8 A, R<sub>G</sub> = 25 Ω, starting T<sub>J</sub> = 25°C.
3. I<sub>SD</sub> ≤ 12 A, di/dt ≤ 200 A/μs, V<sub>DD</sub> ≤ 400 V, starting T<sub>J</sub> = 25°C.

## THERMAL CHARACTERISTICS

Symbol	Parameter	Value	Unit
R <sub>θJC</sub>	Thermal Resistance, Junction to Case, Max.	0.65	°C/W
R <sub>θJA</sub>	Thermal Resistance, Junction to Ambient, Max., (Note 4)	40	

4. Device on 1 in<sup>2</sup> 2-oz copper pad on 1.5 x 1.5 in. board of FR-4 material.

## PACKAGE MARKING AND ORDERING INFORMATION

Part Number	Top Marking	Package	Reel Size	Tape Width	Shipping†
NTB150N65S3HF	NTB150N65S3HF	D <sup>2</sup> PAK	330 mm	24 mm	800 / Tape & Reel

†For information on tape and reel specifications, including part orientation and tape sizes, please refer to our Tape and Reel Packaging Specifications Brochure, BRD8011/D.

# NTB150N65S3HF

## ELECTRICAL CHARACTERISTICS ( $T_C = 25^\circ\text{C}$ unless otherwise noted)

Symbol	Parameter	Test Conditions	Min.	Typ.	Max.	Unit
--------	-----------	-----------------	------	------	------	------

### OFF CHARACTERISTICS

BV <sub>DSS</sub>	Drain to Source Breakdown Voltage	V <sub>GS</sub> = 0 V, I <sub>D</sub> = 1 mA, T <sub>J</sub> = 25°C	650			V
		V <sub>GS</sub> = 0 V, I <sub>D</sub> = 1 mA, T <sub>J</sub> = 150°C	700			V
ΔBV <sub>DSS</sub> / ΔT <sub>J</sub>	Breakdown Voltage Temperature Coefficient	I <sub>D</sub> = 15 mA, Referenced to 25°C		0.62		V/°C
I <sub>DSS</sub>	Zero Gate Voltage Drain Current	V <sub>DS</sub> = 650 V, V <sub>GS</sub> = 0 V			10	μA
		V <sub>DS</sub> = 520 V, T <sub>C</sub> = 125°C		67		
I <sub>GSS</sub>	Gate to Body Leakage Current	V <sub>GS</sub> = ±30 V, V <sub>DS</sub> = 0 V			±100	nA

### ON CHARACTERISTICS

V <sub>GS(th)</sub>	Gate Threshold Voltage	V <sub>GS</sub> = V <sub>DS</sub> , I <sub>D</sub> = 0.54 mA	3.0		5.0	V
R <sub>DS(on)</sub>	Static Drain to Source On Resistance	V <sub>GS</sub> = 10 V, I <sub>D</sub> = 12 A		121	150	mΩ
g <sub>FS</sub>	Forward Transconductance	V <sub>DS</sub> = 20 V, I <sub>D</sub> = 12 A		14		S

### DYNAMIC CHARACTERISTICS

C <sub>iss</sub>	Input Capacitance	V <sub>DS</sub> = 400 V, V <sub>GS</sub> = 0 V, f = 1 MHz		1985		pF
C <sub>oss</sub>	Output Capacitance			40		pF
C <sub>oss(eff.)</sub>	Effective Output Capacitance	V <sub>DS</sub> = 0 V to 400 V, V <sub>GS</sub> = 0 V		400		pF
C <sub>oss(er.)</sub>	Energy Related Output Capacitance	V <sub>DS</sub> = 0 V to 400 V, V <sub>GS</sub> = 0 V		71		pF
Q <sub>g(tot)</sub>	Total Gate Charge at 10 V	V <sub>DS</sub> = 400 V, I <sub>D</sub> = 12 A, V <sub>GS</sub> = 10 V (Note 5)		43		nC
Q <sub>gs</sub>	Gate to Source Gate Charge			13		nC
Q <sub>gd</sub>	Gate to Drain "Miller" Charge			17		nC
ESR	Equivalent Series Resistance	f = 1 MHz		5.0		Ω

### SWITCHING CHARACTERISTICS

t <sub>d(on)</sub>	Turn-On Delay Time	V <sub>DD</sub> = 400 V, I <sub>D</sub> = 12 A, V <sub>GS</sub> = 10 V R <sub>g</sub> = 4.7 Ω (Note 5)		21		ns
t <sub>r</sub>	Turn-On Rise Time			19		ns
t <sub>d(off)</sub>	Turn-Off Delay Time			63		ns
t <sub>f</sub>	Turn-Off Fall Time			14		ns

### SOURCE-DRAIN DIODE CHARACTERISTICS

I <sub>S</sub>	Maximum Continuous Source to Drain Diode Forward Current			24		A
I <sub>SM</sub>	Maximum Pulsed Source to Drain Diode Forward Current			60		A
V <sub>SD</sub>	Source to Drain Diode Forward Voltage	V <sub>GS</sub> = 0 V, I <sub>SD</sub> = 12 A			1.3	V
t <sub>rr</sub>	Reverse Recovery Time	V <sub>DD</sub> = 400 V, I <sub>SD</sub> = 12 A, dI <sub>F</sub> /dt = 100 A/μs		88		ns
Q <sub>rr</sub>	Reverse Recovery Charge			306		nC

Product parametric performance is indicated in the Electrical Characteristics for the listed test conditions, unless otherwise noted. Product performance may not be indicated by the Electrical Characteristics if operated under different conditions.

5. Essentially independent of operating temperature typical characteristics.

# NTB150N65S3HF

## TYPICAL CHARACTERISTICS

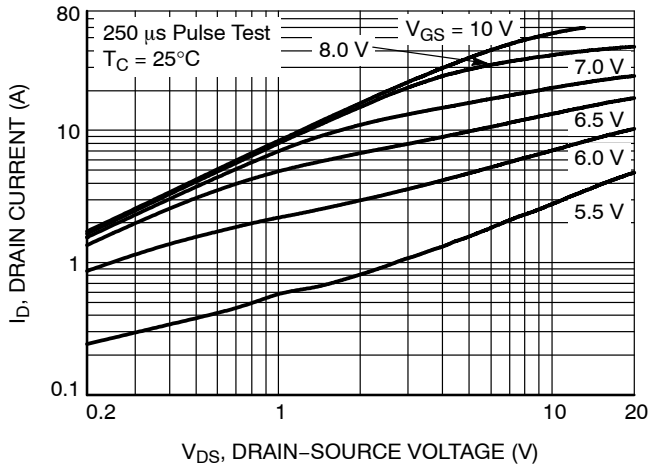

Figure 1. On-Region Characteristics

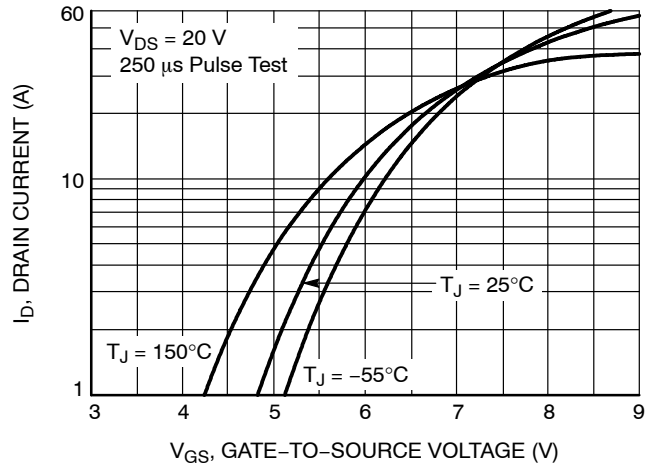

Figure 2. Transfer Characteristics

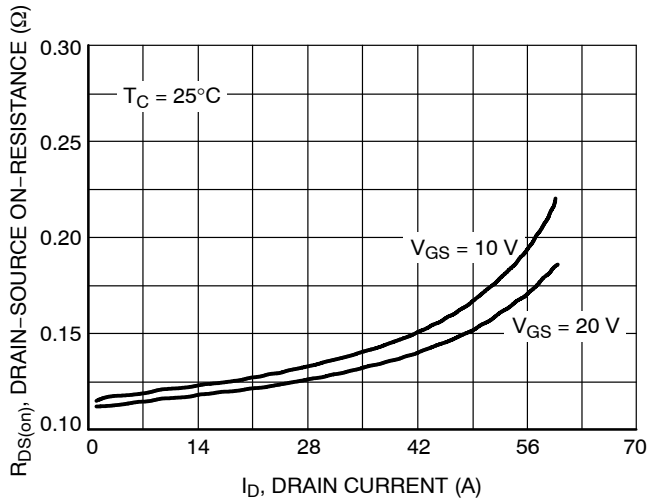

Figure 3. On-Resistance Variation vs. Drain Current and Gate Voltage

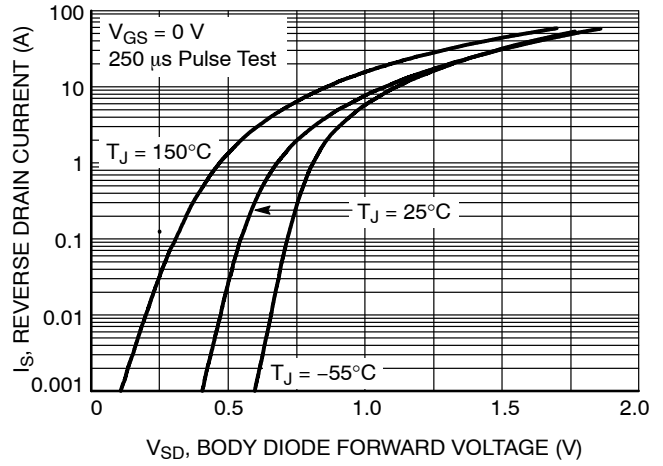

Figure 4. Body Diode Forward Voltage Variation vs. Source Current and Temperature

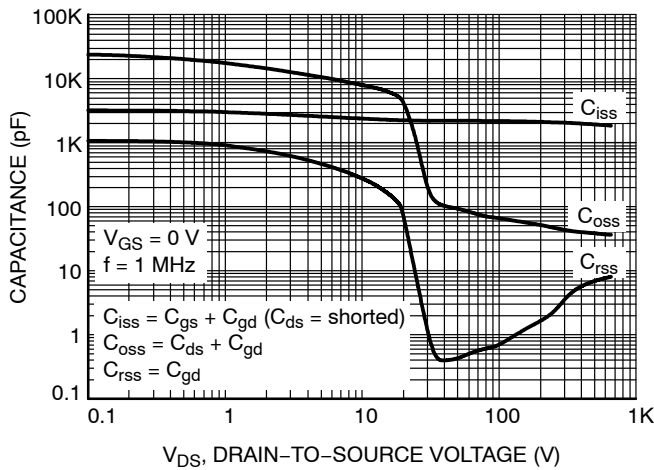

Figure 5. Capacitance Characteristics

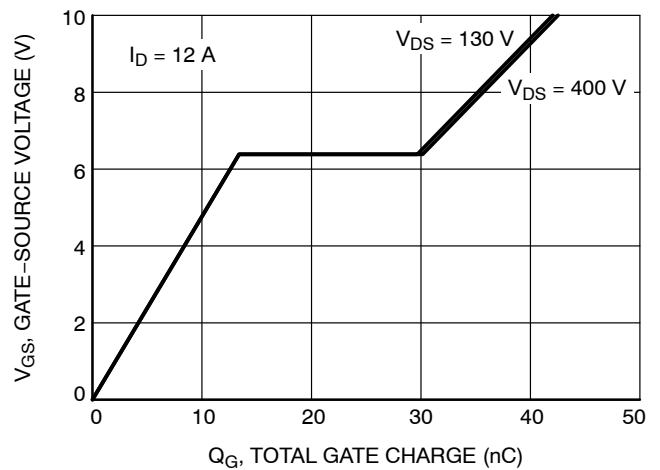
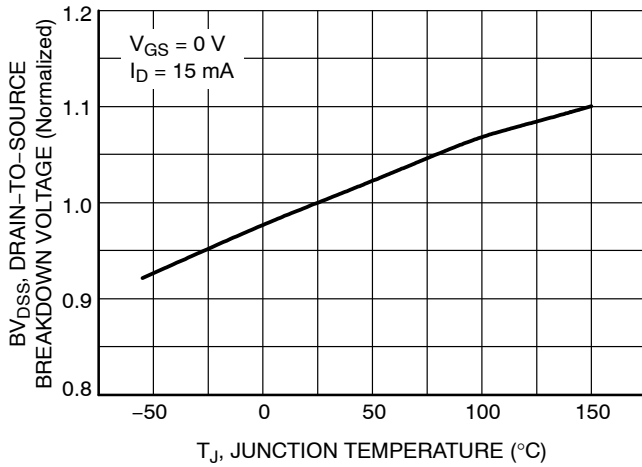

Figure 6. Gate Charge Characteristics

# NTB150N65S3HF

## TYPICAL CHARACTERISTICS



**Figure 7. Breakdown Voltage Variation vs. Temperature**

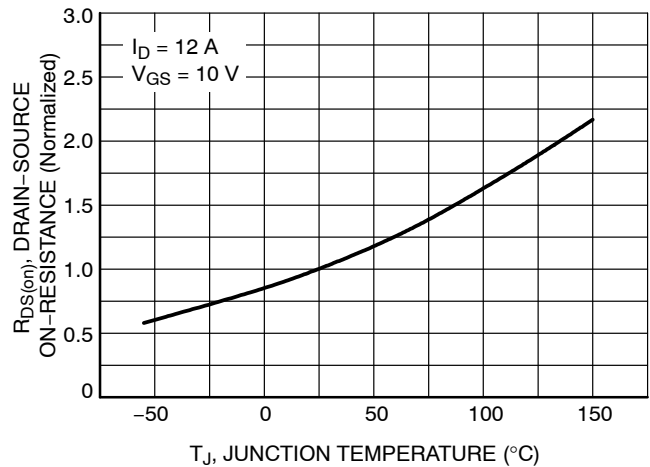

**Figure 8. On-Resistance Variation vs. Temperature**

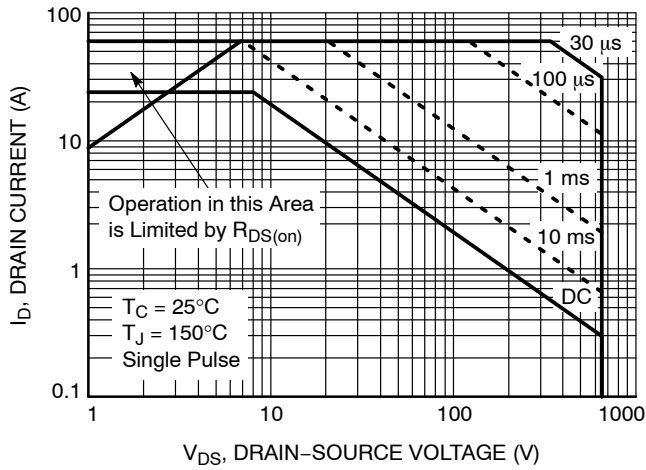

**Figure 9. Maximum Safe Operating Area**

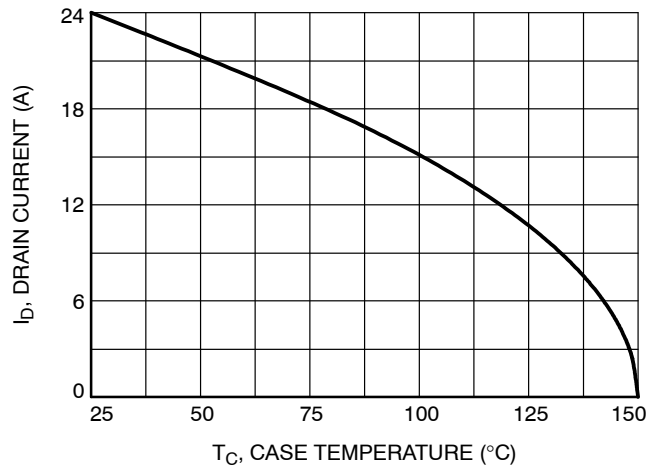

**Figure 10. Maximum Drain Current vs. Case Temperature**

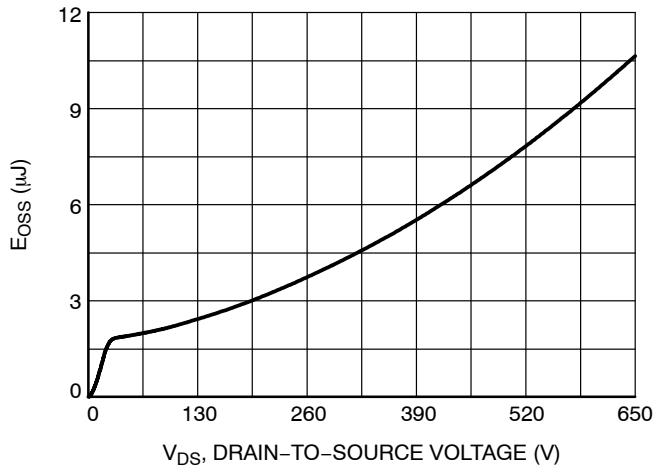

**Figure 11. E<sub>OSS</sub> vs. Drain-to-Source Voltage**

# NTB150N65S3HF

## TYPICAL CHARACTERISTICS

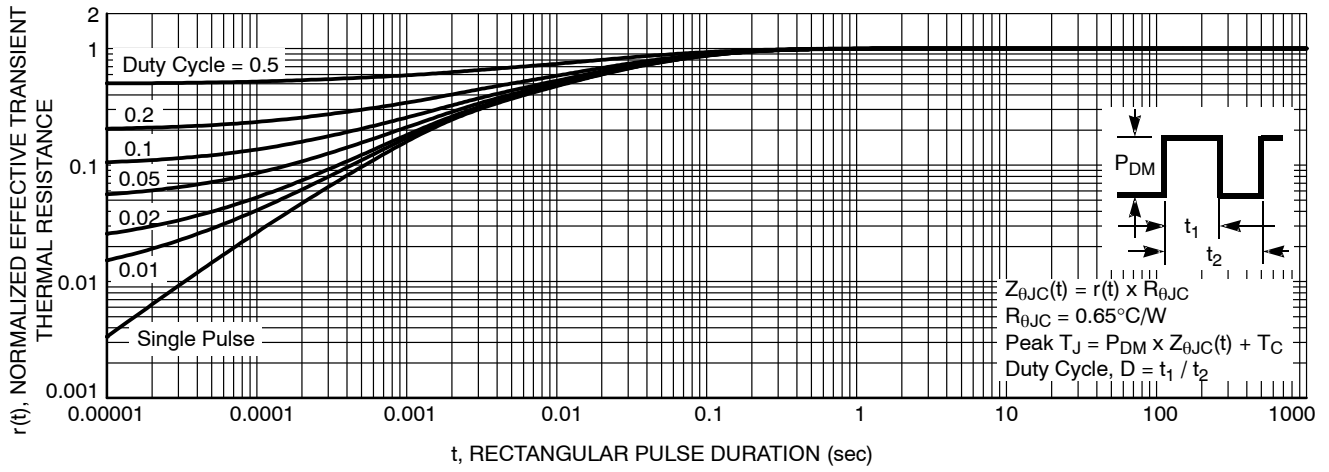

Figure 12. Transient Thermal Response Curve

# NTB150N65S3HF



Figure 13. Gate Charge Test Circuit & Waveform

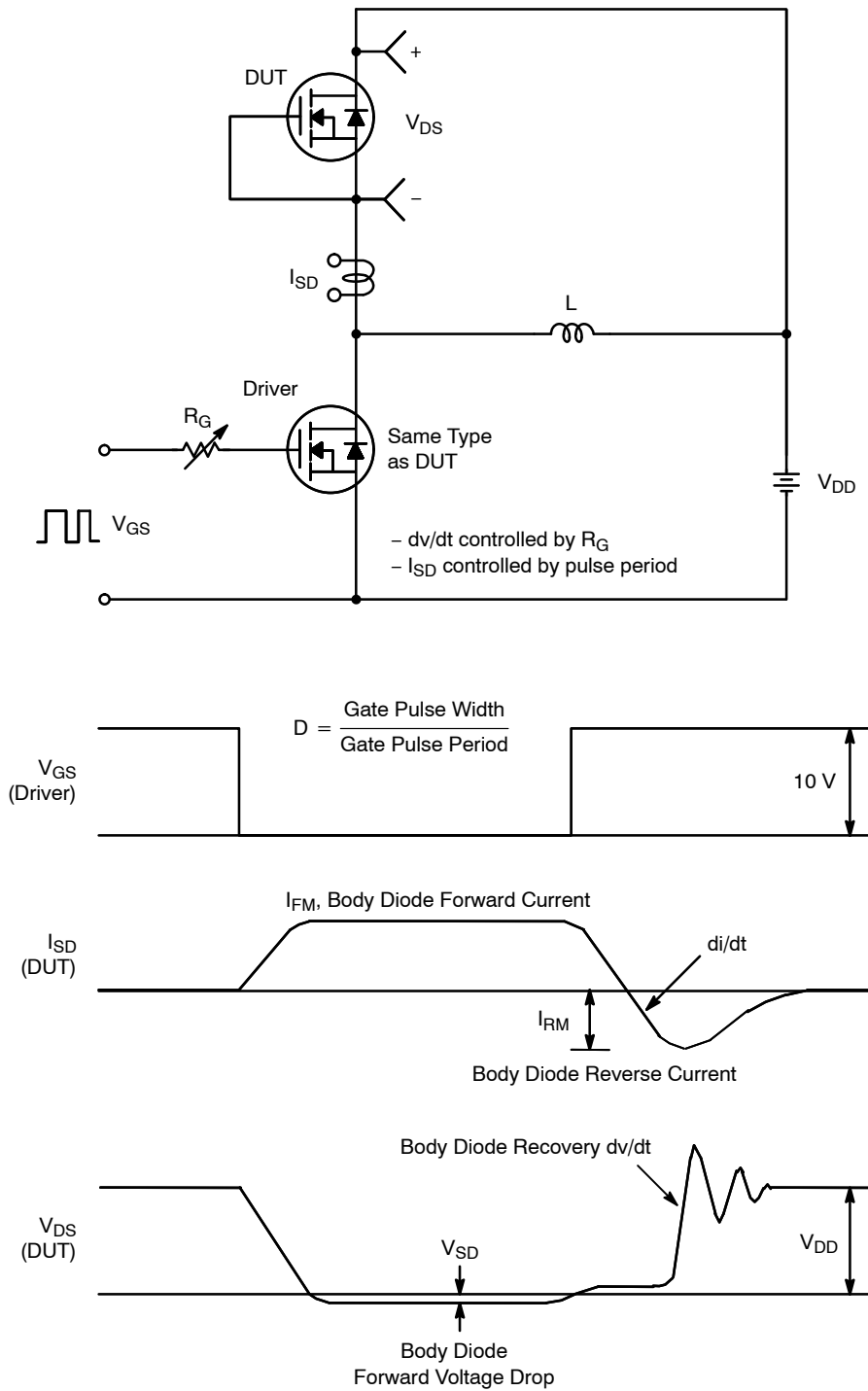

Figure 14. Resistive Switching Test Circuit & Waveforms



Figure 15. Unclamped Inductive Switching Test Circuit & Waveforms

# NTB150N65S3HF



**Figure 16. Peak Diode Recovery  $dv/dt$  Test Circuit & Waveforms**



# MECHANICAL CASE OUTLINE

## PACKAGE DIMENSIONS

ON Semiconductor®

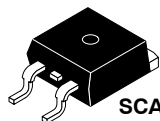

SCALE 1:1

### D<sup>2</sup>PAK-3 (TO-263, 3-LEAD)

#### CASE 418AJ

#### ISSUE F

DATE 11 MAR 2021

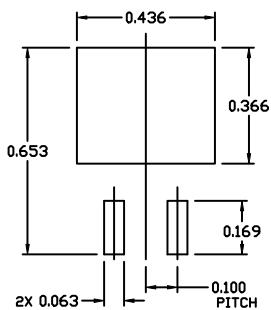

#### RECOMMENDED MOUNTING FOOTPRINT

For additional information on our Pb-Free strategy and soldering details, please download the ON Semiconductor Soldering and Mounting Techniques Reference Manual, SOLDERRM/D.

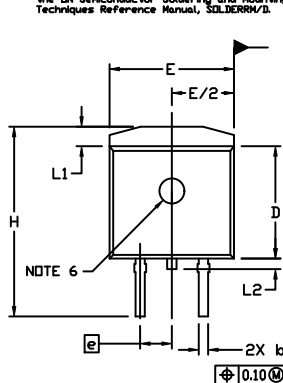

#### NOTES:

- DIMENSIONING AND TOLERANCING PER ASME Y14.5M, 2009.
- CONTROLLING DIMENSION: INCHES
- CHAMFER OPTIONAL.
- DIMENSIONS D AND E DO NOT INCLUDE MOLD FLASH. MOLD FLASH SHALL NOT EXCEED 0.005 PER SIDE. THESE DIMENSIONS ARE MEASURED AT THE OUTERMOST EXTREMES OF THE PLASTIC BODY AT DATUM H.
- THERMAL PAD CONTOUR IS OPTIONAL WITHIN DIMENSIONS E, L1, D1, AND E1.
- OPTIONAL MOLD FEATURE.
- ①, ② ... OPTIONAL CONSTRUCTION FEATURE CALL OUTS.

DIM	INCHES		MILLIMETERS	
	MIN.	MAX.	MIN.	MAX.
A	0.160	0.190	4.06	4.83
A1	0.000	0.010	0.00	0.25
b	0.020	0.039	0.51	0.99
c	0.012	0.029	0.30	0.74
c2	0.045	0.065	1.14	1.65
D	0.330	0.380	8.38	9.65
D1	0.260	---	6.60	---
E	0.380	0.420	9.65	10.67
E1	0.245	---	6.22	---
e	0.100	BSC	2.54	BSC
H	0.575	0.625	14.60	15.88
L	0.070	0.110	1.78	2.79
L1	---	0.066	---	1.68
L2	---	0.070	---	1.78
L3	0.010	BSC	0.25	BSC
M	0*	8*	0*	8*

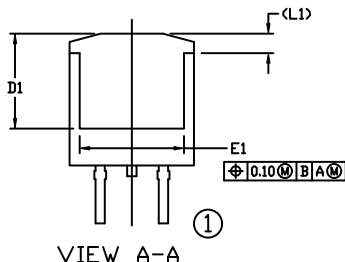
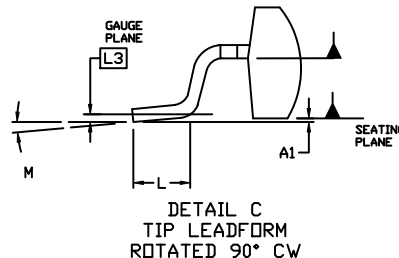
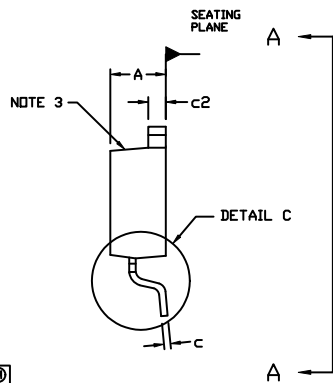

VIEW A-A

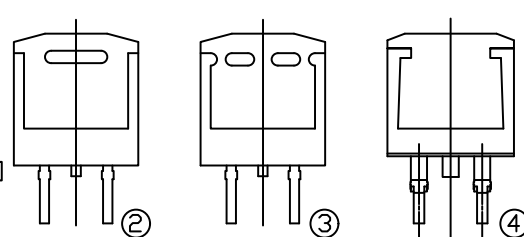

VIEW A-A  
OPTIONAL CONSTRUCTIONS

#### GENERIC MARKING DIAGRAMS\*

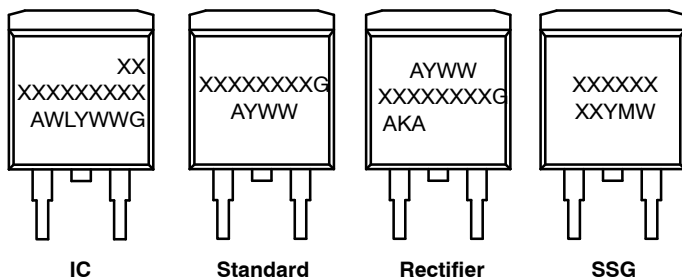

IC

Standard

Rectifier

SSG

- XXXXXX = Specific Device Code
- A = Assembly Location
- WL = Wafer Lot
- Y = Year
- WW = Work Week
- W = Week Code (SSG)
- M = Month Code (SSG)
- G = Pb-Free Package
- AKA = Polarity Indicator

\*This information is generic. Please refer to device data sheet for actual part marking. Pb-Free indicator, "G" or microdot "▪", may or may not be present. Some products may not follow the Generic Marking.

DOCUMENT NUMBER:	98AON56370E	Electronic versions are uncontrolled except when accessed directly from the Document Repository. Printed versions are uncontrolled except when stamped "CONTROLLED COPY" in red.
DESCRIPTION:	D <sup>2</sup> PAK-3 (TO-263, 3-LEAD)	PAGE 1 OF 1

ON Semiconductor and ON are trademarks of Semiconductor Components Industries, LLC dba ON Semiconductor or its subsidiaries in the United States and/or other countries. ON Semiconductor reserves the right to make changes without further notice to any products herein. ON Semiconductor makes no warranty, representation or guarantee regarding the suitability of its products for any particular purpose, nor does ON Semiconductor assume any liability arising out of the application or use of any product or circuit, and specifically disclaims any and all liability, including without limitation special, consequential or incidental damages. ON Semiconductor does not convey any license under its patent rights nor the rights of others.

**onsemi**, **Onsemi**, and other names, marks, and brands are registered and/or common law trademarks of Semiconductor Components Industries, LLC dba "**onsemi**" or its affiliates and/or subsidiaries in the United States and/or other countries. **onsemi** owns the rights to a number of patents, trademarks, copyrights, trade secrets, and other intellectual property. A listing of **onsemi**'s product/patent coverage may be accessed at [www.onsemi.com/site/pdf/Patent-Marking.pdf](http://www.onsemi.com/site/pdf/Patent-Marking.pdf). **onsemi** reserves the right to make changes at any time to any products or information herein, without notice. The information herein is provided "as-is" and **onsemi** makes no warranty, representation or guarantee regarding the accuracy of the information, product features, availability, functionality, or suitability of its products for any particular purpose, nor does **onsemi** assume any liability arising out of the application or use of any product or circuit, and specifically disclaims any and all liability, including without limitation special, consequential or incidental damages. Buyer is responsible for its products and applications using **onsemi** products, including compliance with all laws, regulations and safety requirements or standards, regardless of any support or applications information provided by **onsemi**. "Typical" parameters which may be provided in **onsemi** data sheets and/or specifications can and do vary in different applications and actual performance may vary over time. All operating parameters, including "Typicals" must be validated for each customer application by customer's technical experts. **onsemi** does not convey any license under any of its intellectual property rights nor the rights of others. **onsemi** products are not designed, intended, or authorized for use as a critical component in life support systems or any FDA Class 3 medical devices or medical devices with a same or similar classification in a foreign jurisdiction or any devices intended for implantation in the human body. Should Buyer purchase or use **onsemi** products for any such unintended or unauthorized application, Buyer shall indemnify and hold **onsemi** and its officers, employees, subsidiaries, affiliates, and distributors harmless against all claims, costs, damages, and expenses, and reasonable attorney fees arising out of, directly or indirectly, any claim of personal injury or death associated with such unintended or unauthorized use, even if such claim alleges that **onsemi** was negligent regarding the design or manufacture of the part. **onsemi** is an Equal Opportunity/Affirmative Action Employer. This literature is subject to all applicable copyright laws and is not for resale in any manner.

## ADDITIONAL INFORMATION

### TECHNICAL PUBLICATIONS:

Technical Library: [www.onsemi.com/design/resources/technical-documentation](http://www.onsemi.com/design/resources/technical-documentation)  
onsemi Website: [www.onsemi.com](http://www.onsemi.com)

### ONLINE SUPPORT: [www.onsemi.com/support](http://www.onsemi.com/support)

For additional information, please contact your local Sales Representative at [www.onsemi.com/support/sales](http://www.onsemi.com/support/sales)